



SNS COLLEGE OF TECHNOLOGY

An Autonomous Institution

Coimbatore-35



Accredited by NBA – AICTE and Accredited by NAAC – UGC with 'A+' Grade
Approved by AICTE, New Delhi & Affiliated to Anna University, Chennai

DEPARTMENT OF ELECTRONICS & COMMUNICATION ENGINEERING

19ECB212 – DIGITAL SIGNAL PROCESSING

II YEAR/ IV SEMESTER

UNIT 1 – DISCRETE FOURIER TRANSFORM

TOPIC – FAST FOURIER TRANSFORM - DIT



PROBLEM



1

- Conversion from time to frequency domain is slow

2

- Cannot able to apply for vast applications

3

- Filtering of the signals is also a slow process



METHOD

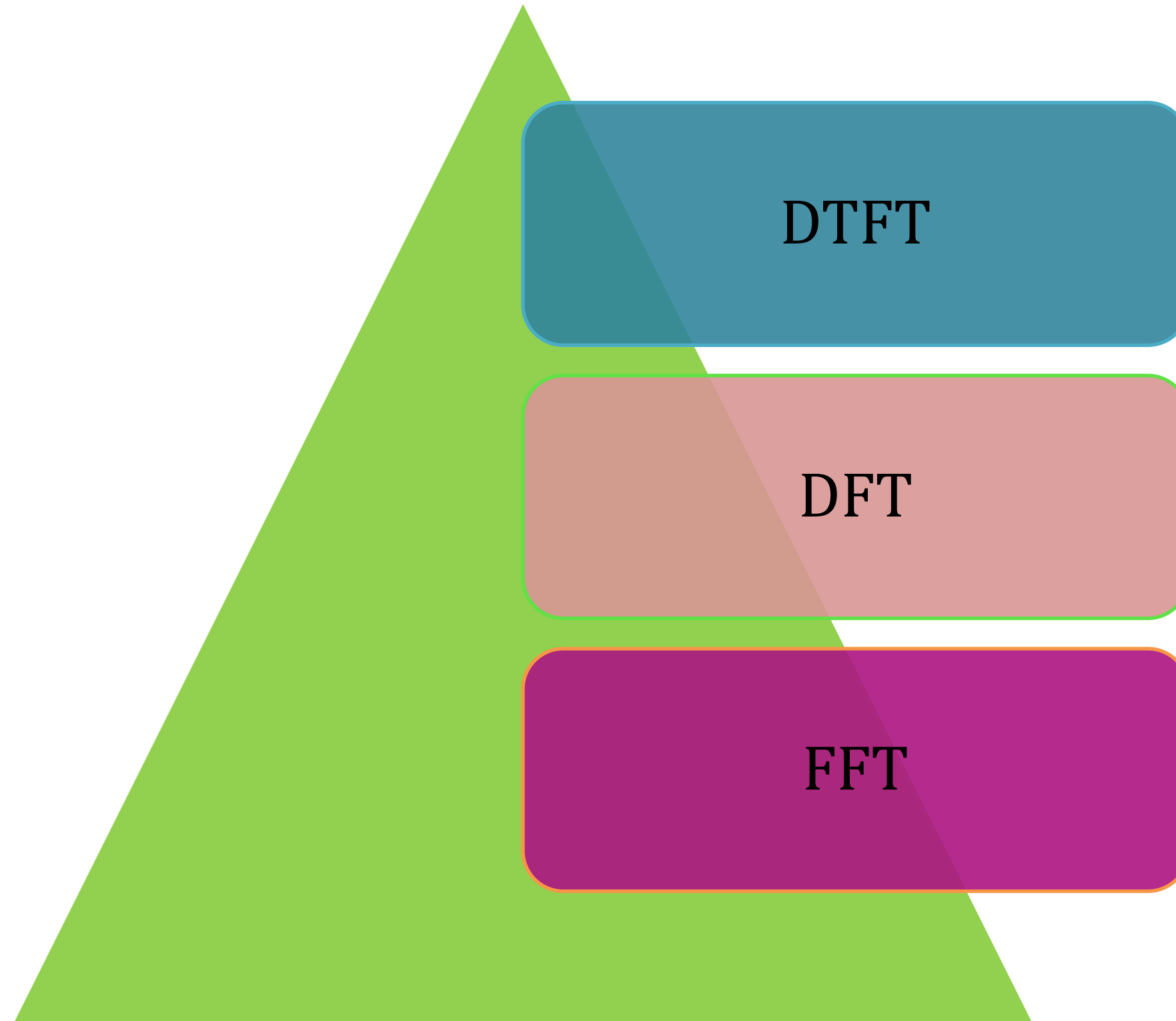



FAST FOURIER TRANSFORM



- The Fast Fourier Transform (FFT) is a family of algorithms that calculates efficiently the Discrete Fourier Transform (DFT)
- The DFT is also a sequence, $X[k]$
- This efficiency of the FFT is at a maximum when the length of the sequence is a power of 2, i.e., $N=2^p$, with p is a positive integer
- The complexity of FFT algorithms is $O(N\log_2 N)$.



FAST FOURIER TRANSFORM

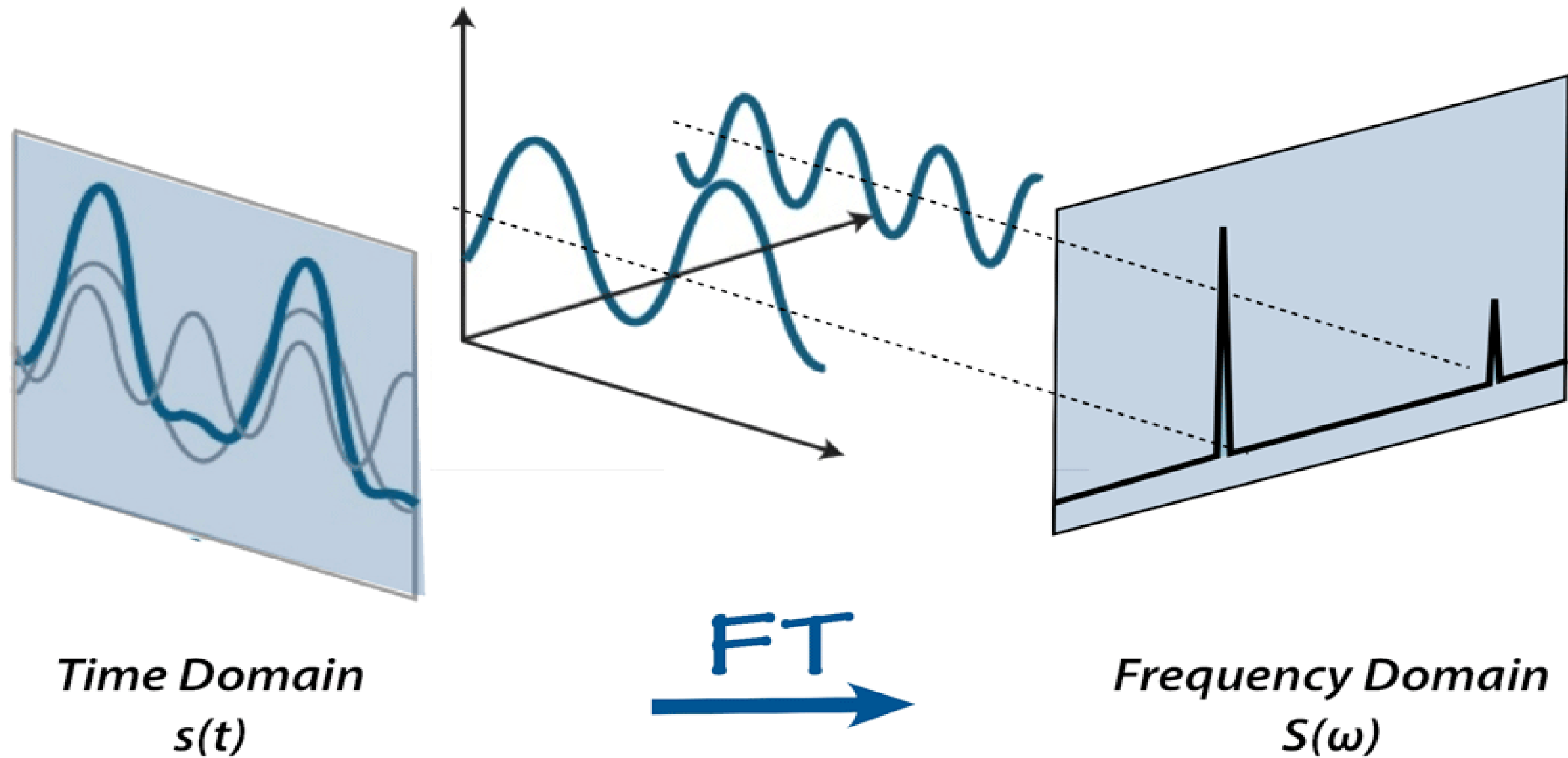



METHODS OF FFT



DIT

- **Decimation in Time**

DIF

- **Decimation in Frequency**



RADIX 2 DIT FFT

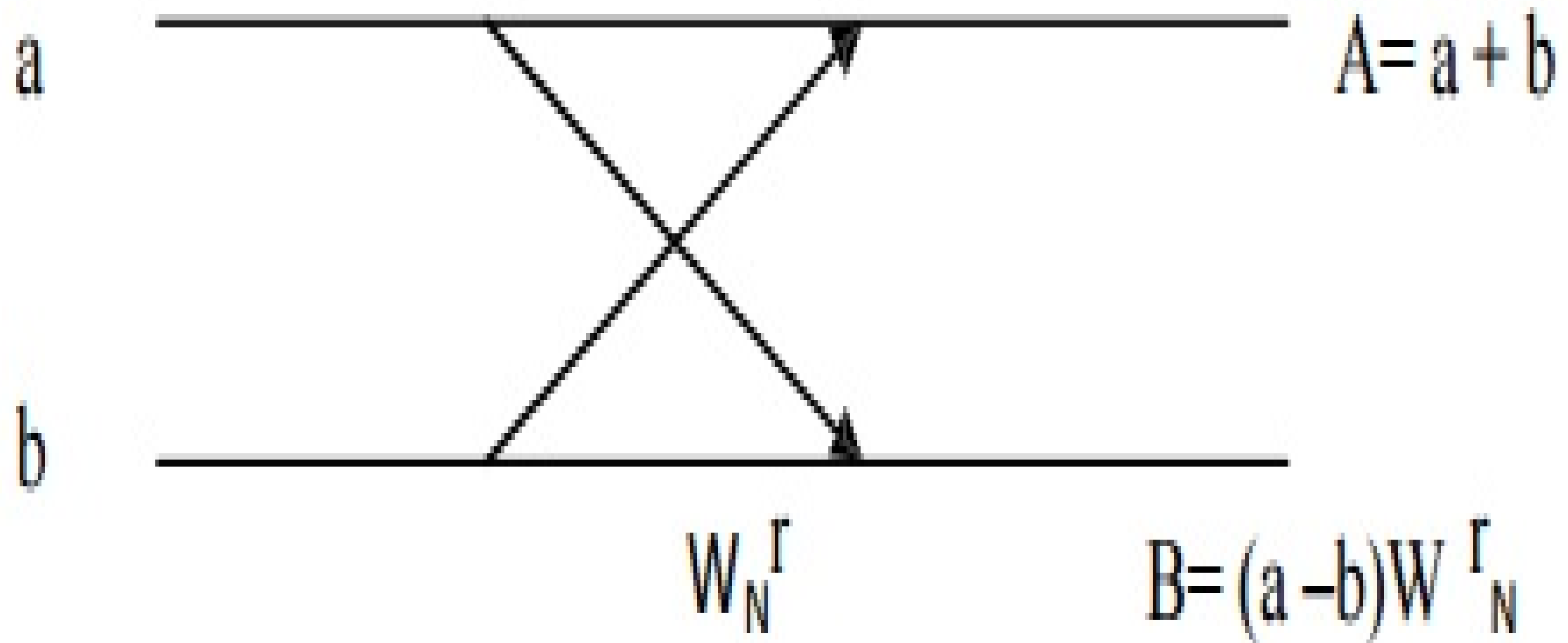



DECIMATION IN TIME FLOW GRAPH

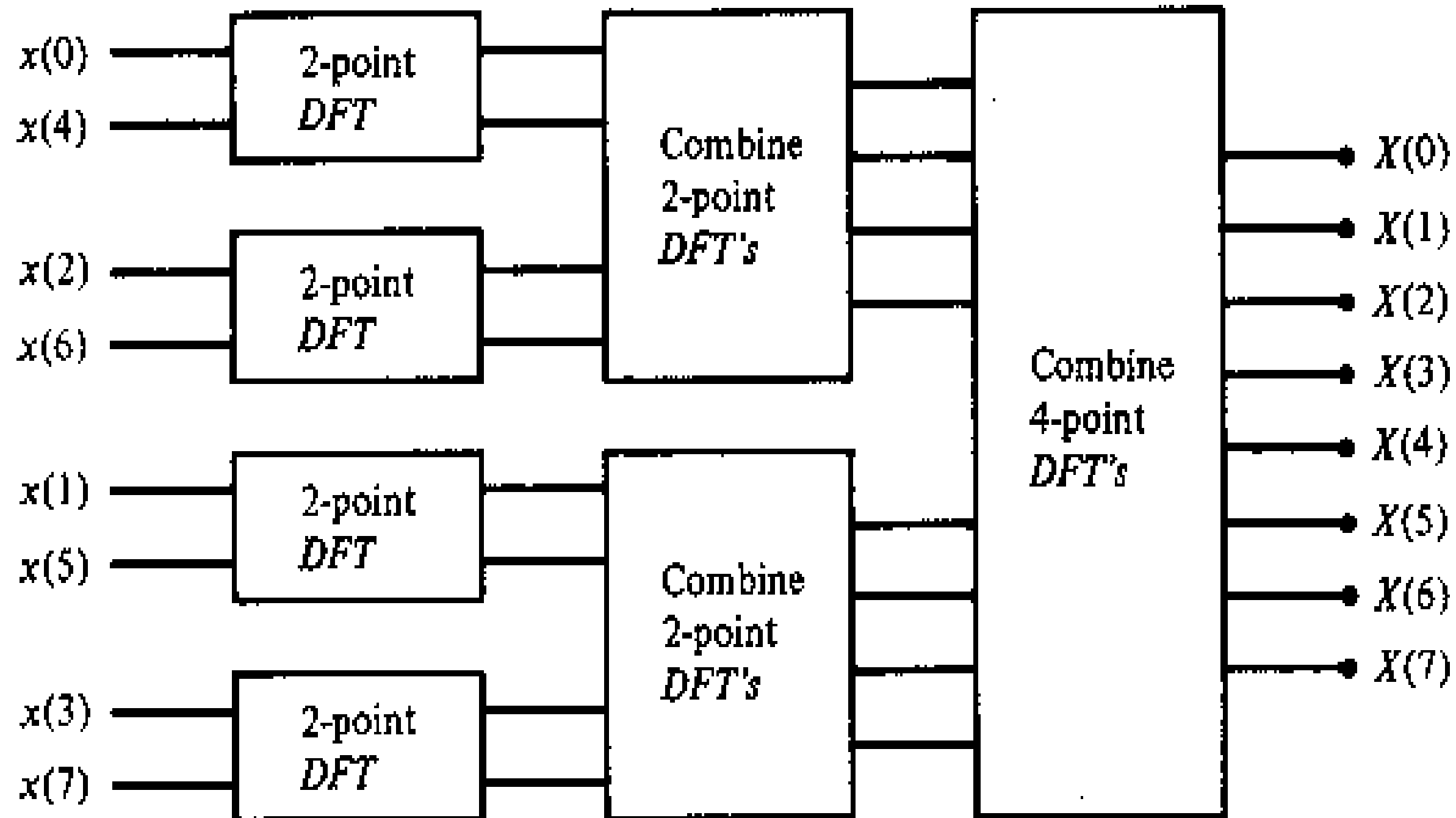



4 POINT DECIMATION IN TIME FFT

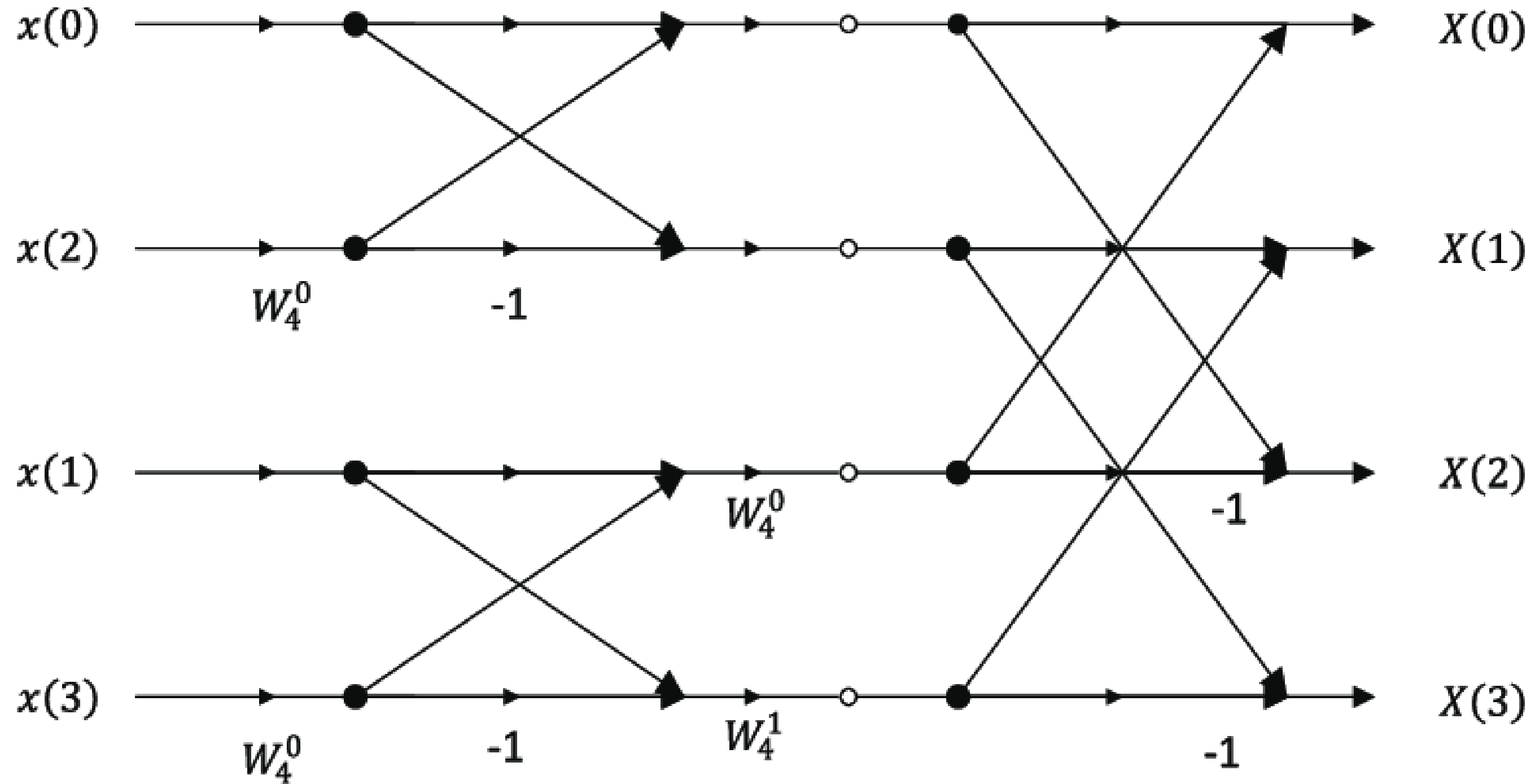



8 POINT DECIMATION IN TIME FFT

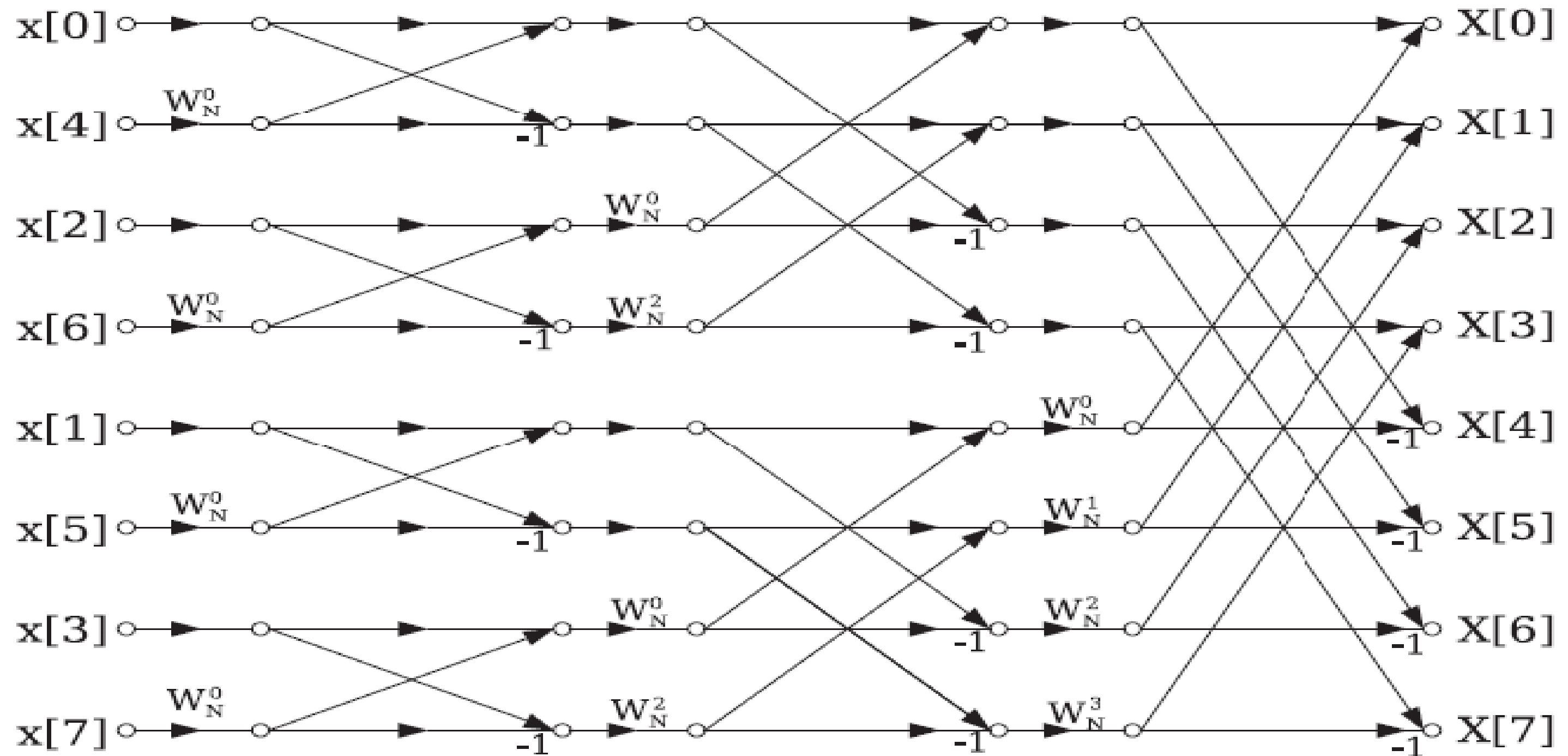



DECIMATION IN TIME FFT

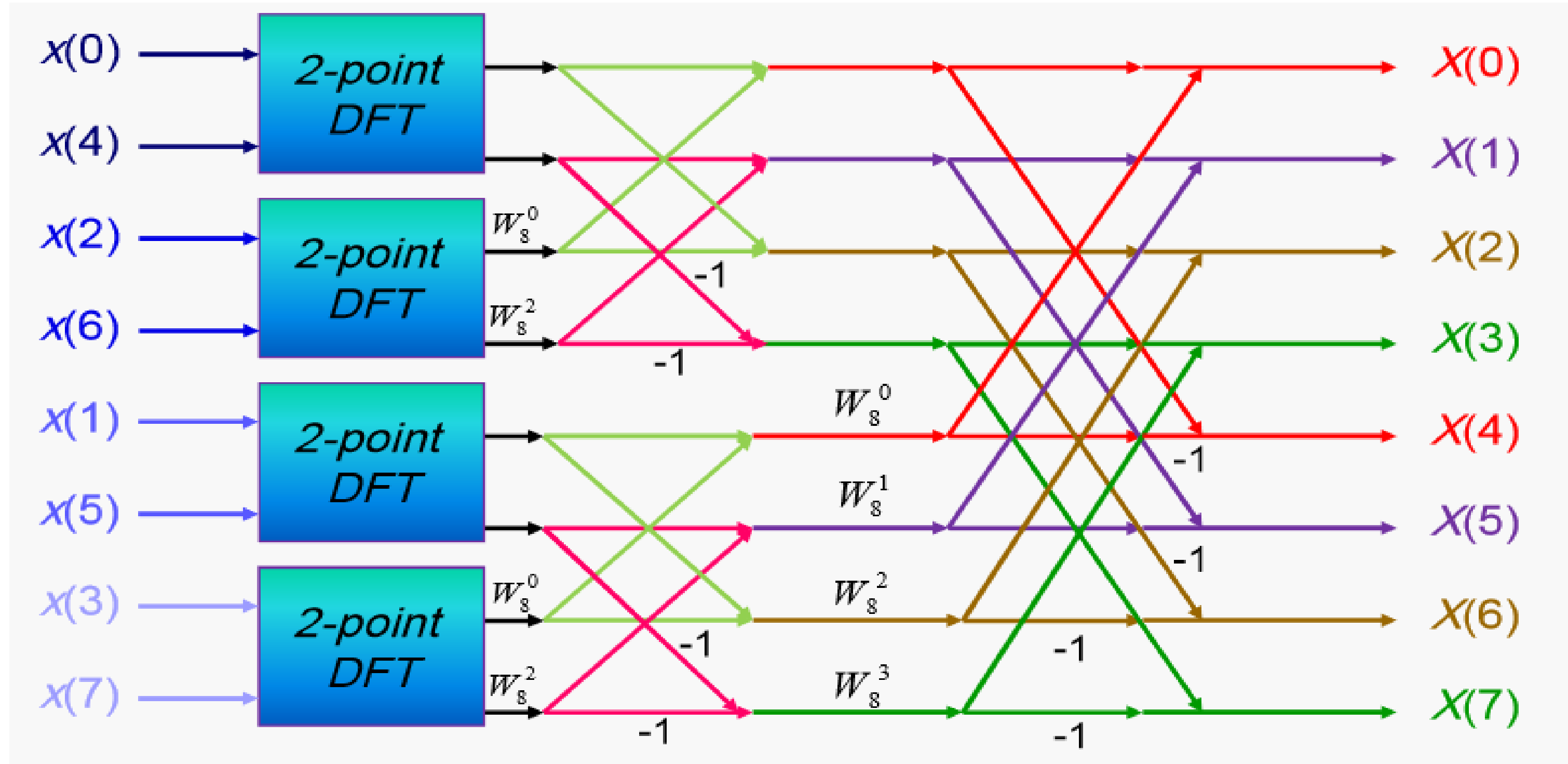



DECIMATION IN TIME FFT

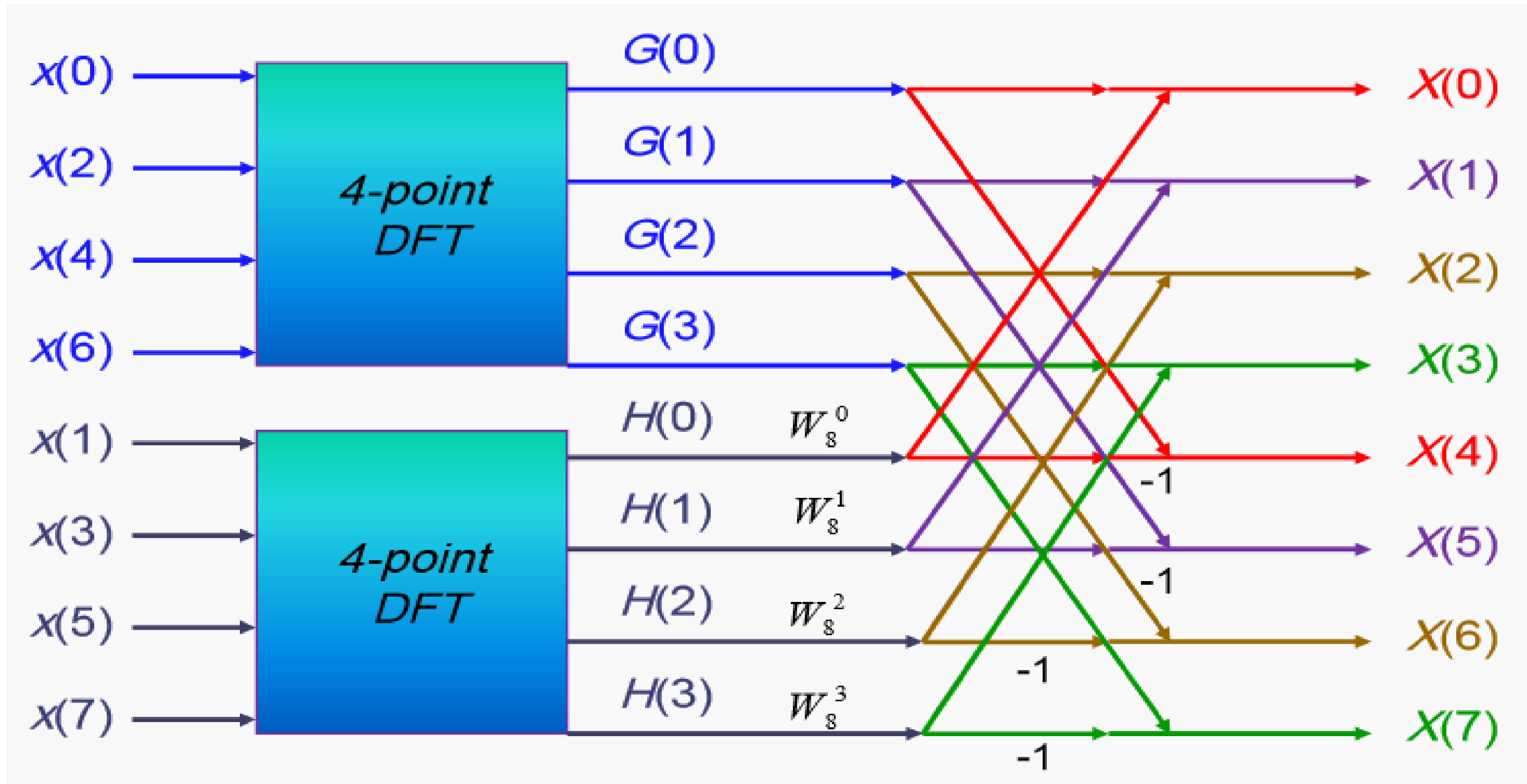



DECIMATION IN TIME FFT

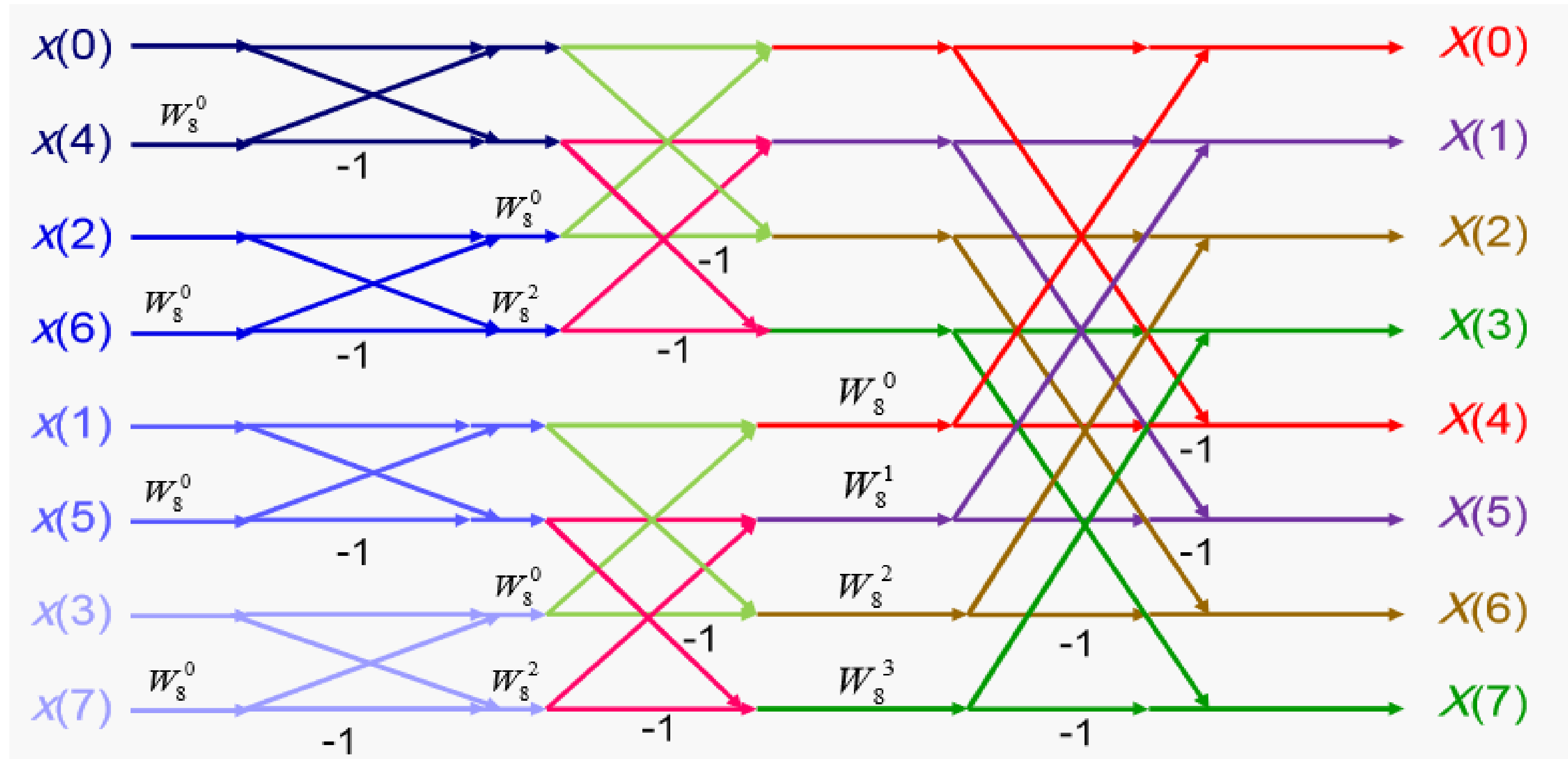



INPUT SEQUENCE ORDER



Original	Binary Form	Reversed Form	Final
0	000	000	0
1	001	100	4
2	010	010	2
3	011	110	6
4	100	001	1
5	101	101	5
6	110	011	3
7	111	111	7



COMPLEX MULTIPLICATIONS



- *Each inner product requires N complex multiplications*
- *There are N inner products*
- *Hence we require N^2 multiplications*
- *However, the first row and first column are all 1s, and should not be counted as multiplications*
- *There are $2N - 1$ such instances*
- *Hence, the number of complex multiplications is $N^2 - 2N + 1$, i.e., $(N - 1)^2$*



COMPLEX ADDITIONS



- *Each inner product requires $N - 1$ complex additions*
- *There are N inner products*
- *Hence we require $N(N - 1)$ complex additions*
- ***No. of complex multiplications: $(N - 1)^2$***
- ***No. of complex additions: $N(N - 1)$***



DECIMATION IN TIME



Given $x(n)=\{1,2,3,4\}$, find $X[k]$ using 4 Point DIT FFT algorithm

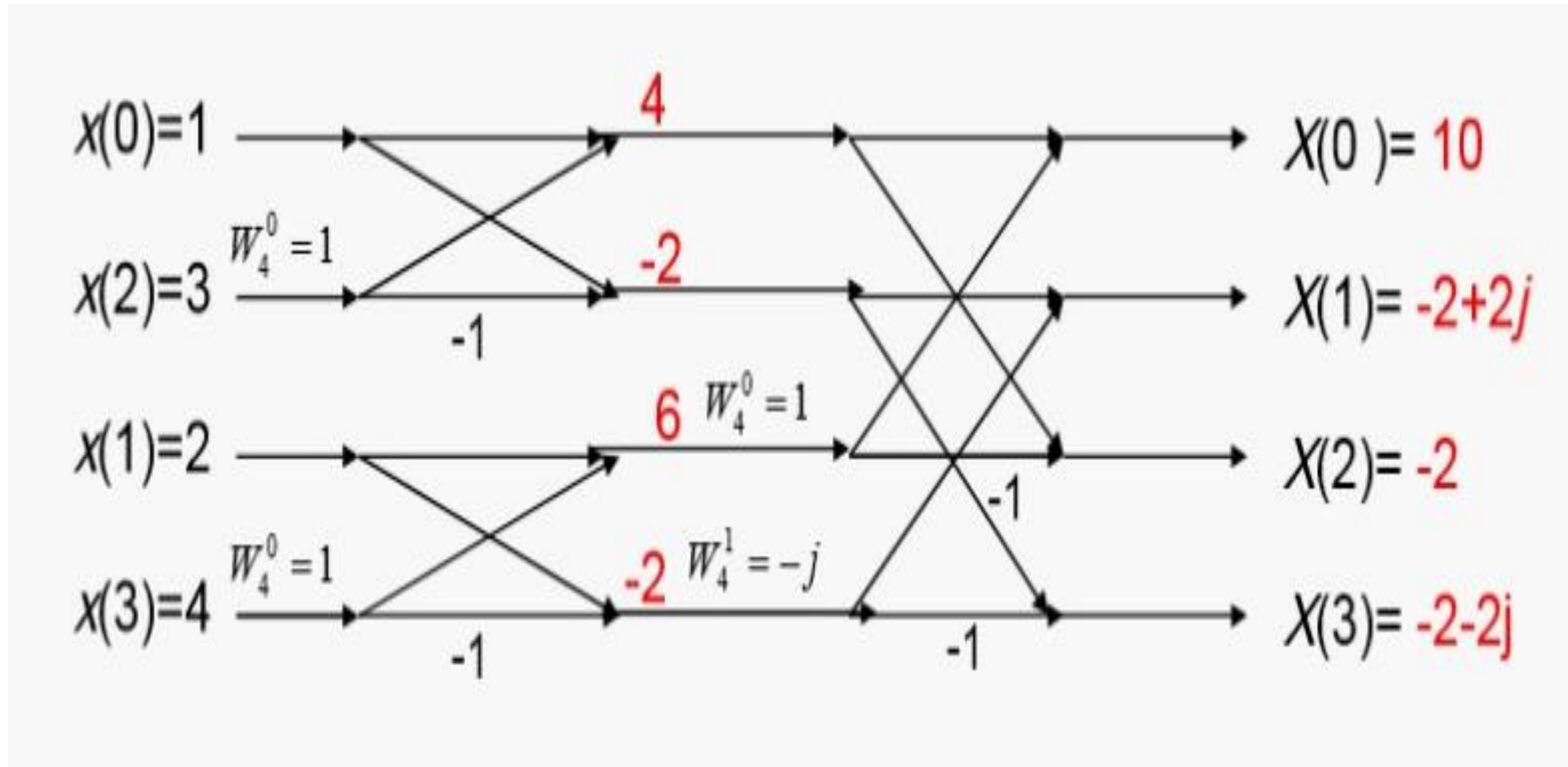



DECIMATION IN TIME - STAGE 1



Given $x(n)=\{0,1,2,3,4,5,6,7\}$, find $X[k]$ using DIT FFT algorithm

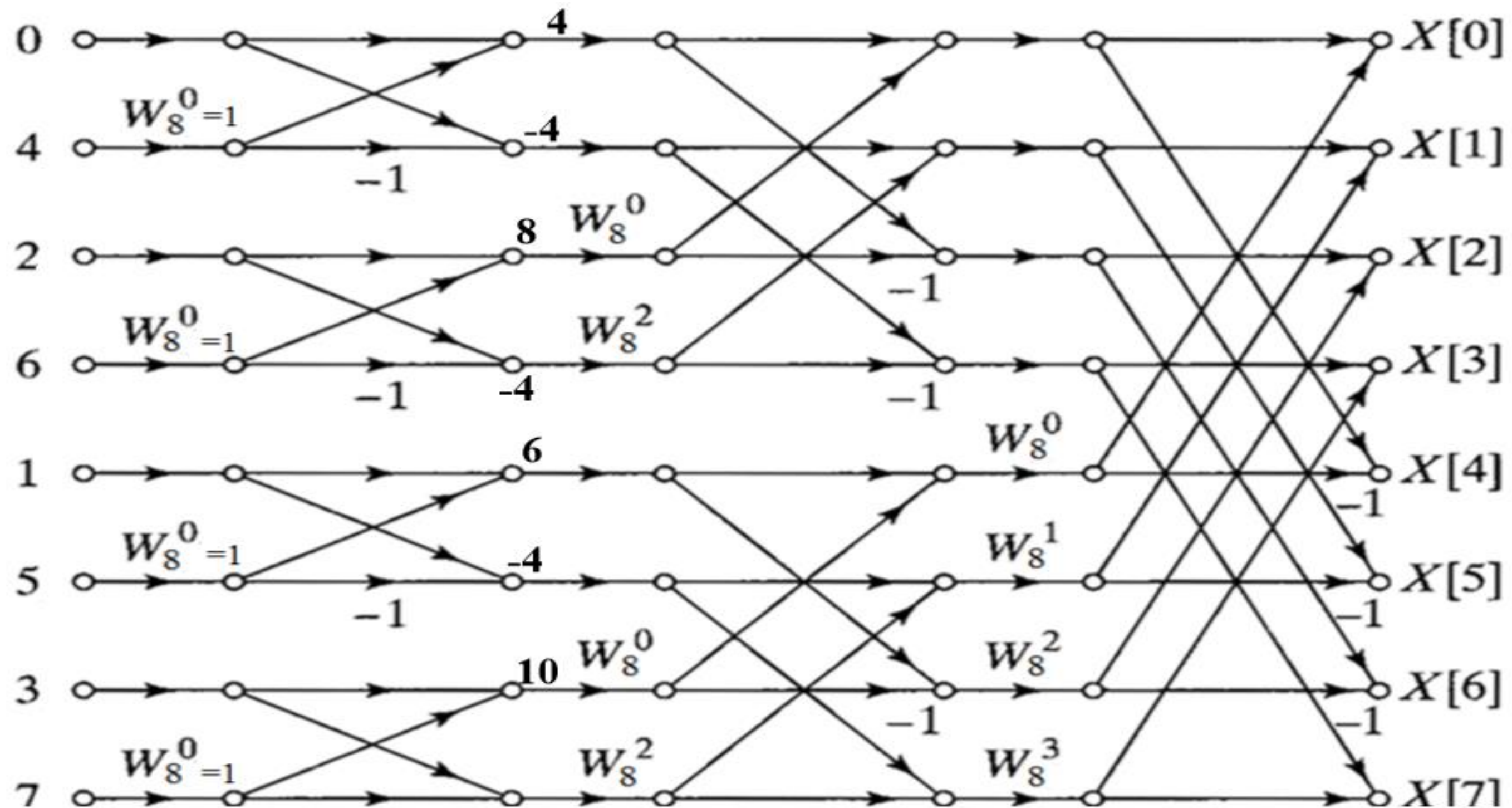



DECIMATION IN TIME - STAGE 2

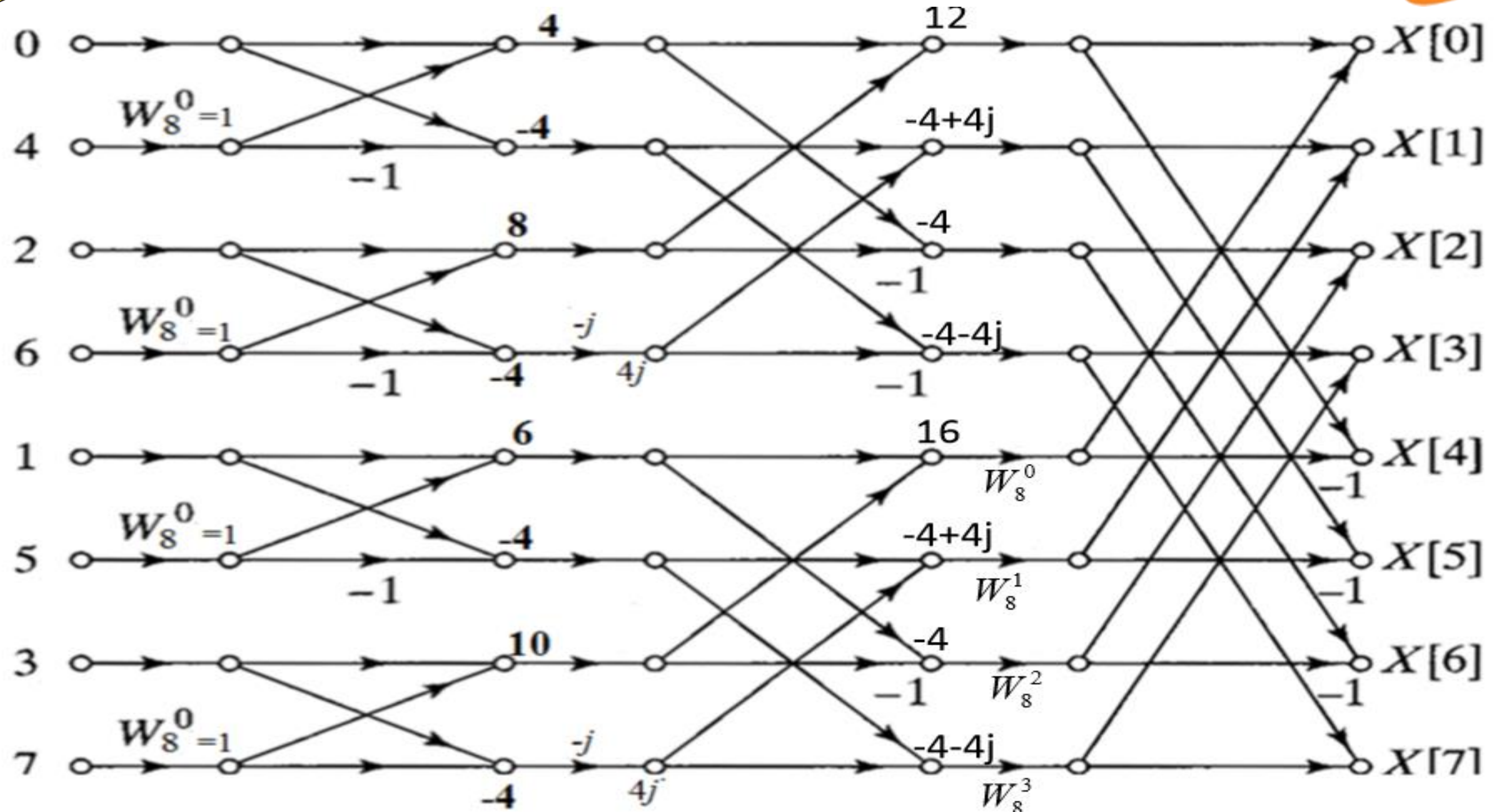



DECIMATION IN TIME - STAGE 3

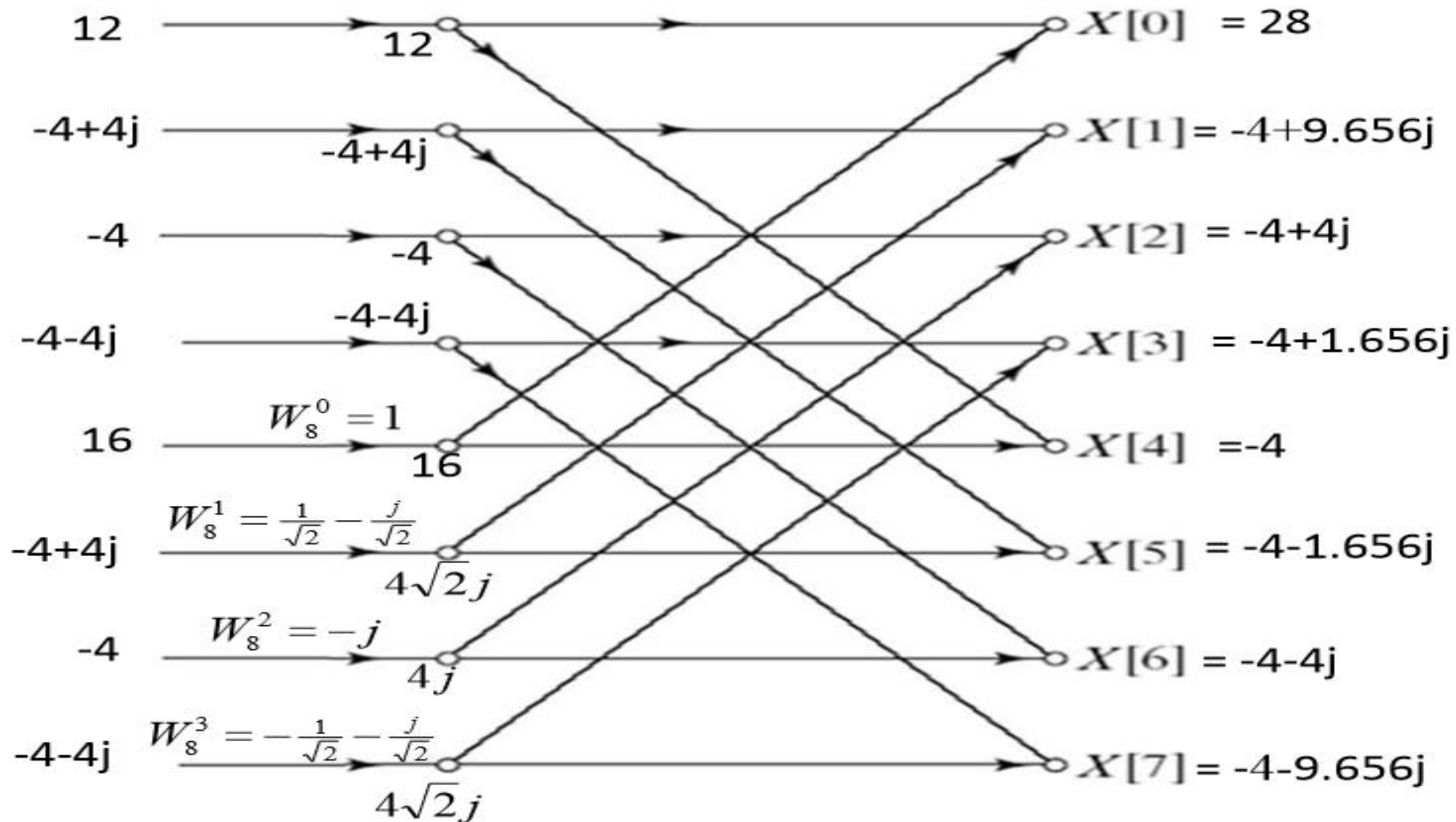



DIFFERENCE B/W DIRECT COMPUTATION & RADIX-2 FFT



S.No.	Direct Computation	Radix 2 FFT
1	Direct computation requires large number of computations as compared with FFT algorithms.	Radix-2 FFT algorithms requires less number of computations.
2	Processing time is more and more for large number of N hence processor remains busy.	Processing time is less hence these algorithms compute DFT very quickly as compared with direct computation.
3	Direct computation does not requires splitting operation.	Splitting operation is done on time domain basis (DIT) or frequency domain basis (DIF)
4	As the value of N in DFT increases, the efficiency of direct computation decreases.	As the value of N in DFT increases, the efficiency of FFT algorithms increases.



ASSESSMENT



1. What is meant by FFT and list the methods of FFT.
2. In Fast Fourier Transform, ----- domain can be converted into ----- domain.
3. In Decimation in Time, the flow graph is represented as -----, 4 – Point and -----FFT.
4. What is the difference between direct computation and Radix 2 FFT.
5. Determine DIT of $x(n) = \{ 1,2,3,4\}$
6. In Fast Fourier Transform,

No. of complex multiplications: ----- No. of complex additions: -----



THANK YOU