



SNS College of Technology

[An Autonomous Institution]

Approved by AICTE, New Delhi, Affiliated to Anna University, Chennai

Accredited by NAAC-UGC with 'A++' Grade (Cycle III) &

Accredited by NBA (B.E CSE, EEE, ECE, IT & Mech)

COIMBATORE-641 035, TAMIL NADU



Department of Aerospace Engineering



19AST202 AIRCRAFT PRODUCTION TECHNOLOGY

ADDITIVE MANUFACTURING IN AEROSPACE

Rapid Prototyping & Rapid Tooling

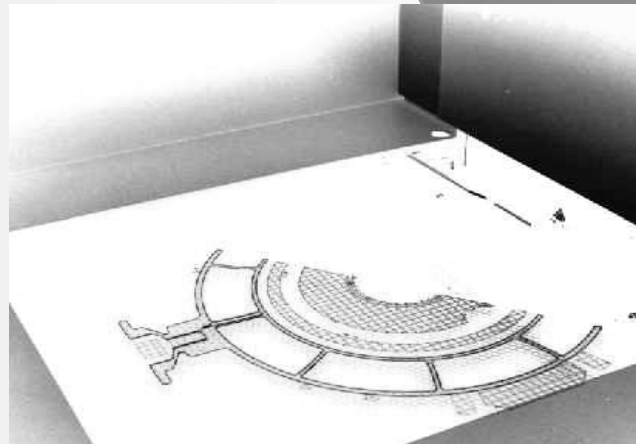
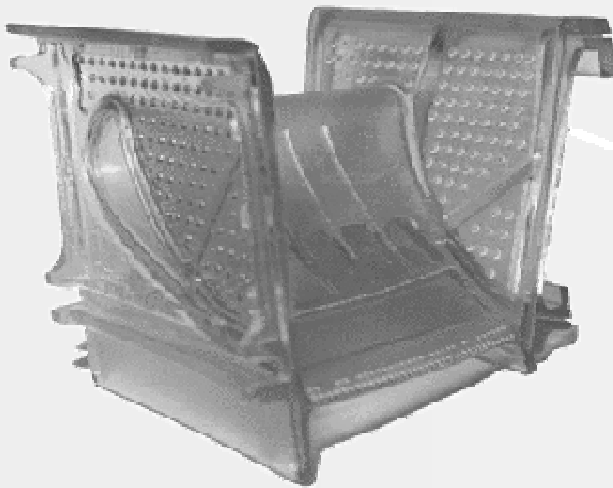

Prepared by Dr.M .Subramanian Professor & Head of Aerospace Engineering

Rapid Prototyping achievements

- Reduction in prototyping times (from weeks to days)
- Reduction in prototyping costs (from thousands to hundreds \$)
- Increase of the possible design iterations (from 2-3 to 8-9)
- Increase of possible form, fit, function tests

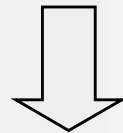

Shorter design cycle

Reduced Time-to-Market

Rapid Prototyping



Computer model

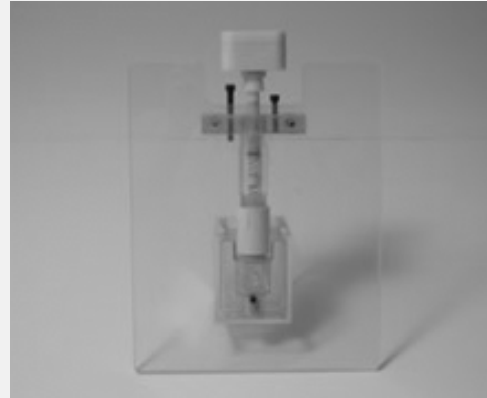
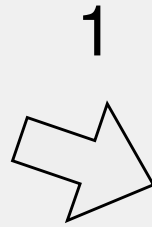

Mechanical model

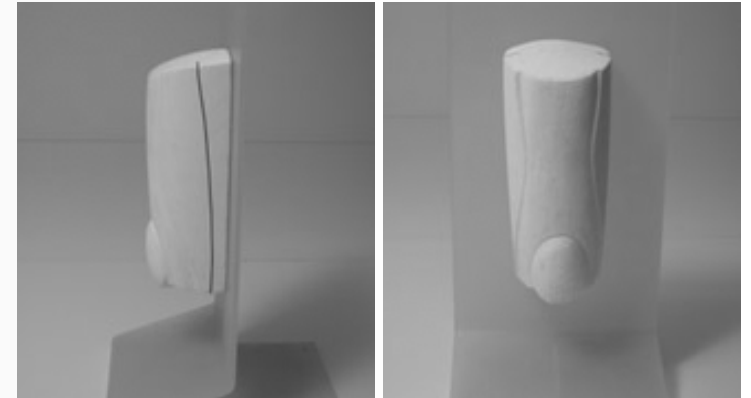
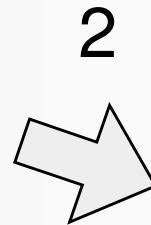

Visual model

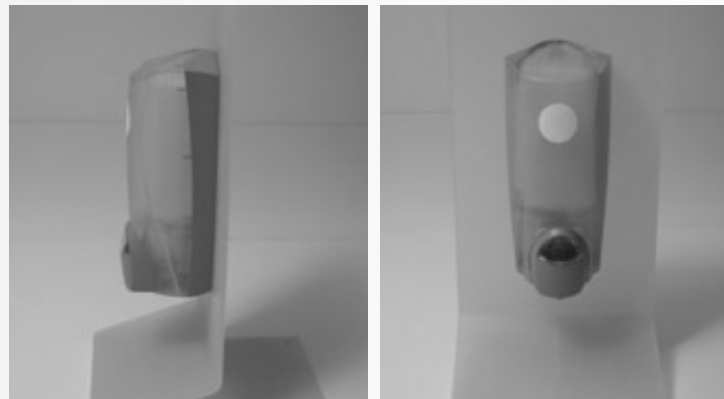
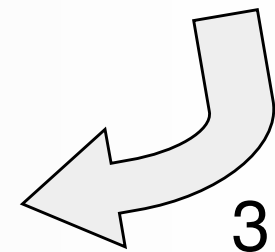

Mechanical functional model

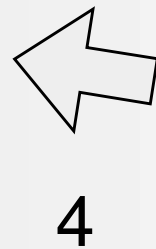

Production product

Rapid Prototyping Market

2001

- 3,55 Millions of models produced worldwide
- 400 Service providers
- 8000 Machines sold since 1993

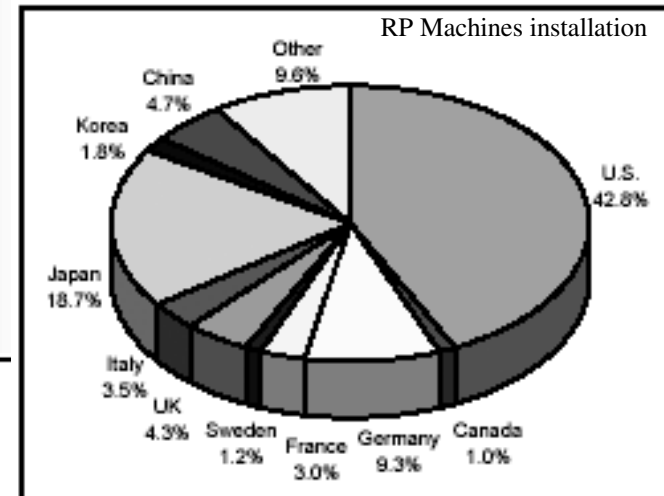
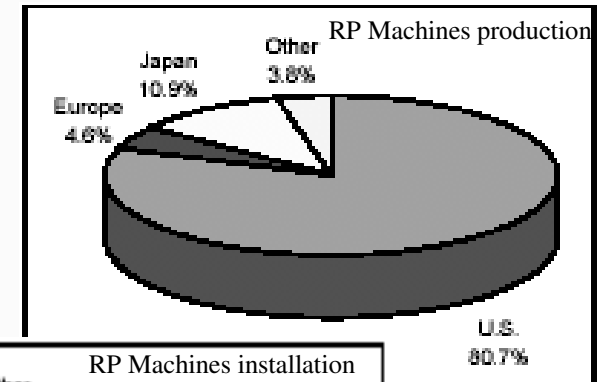

Source: Wohlers Associates, Inc.

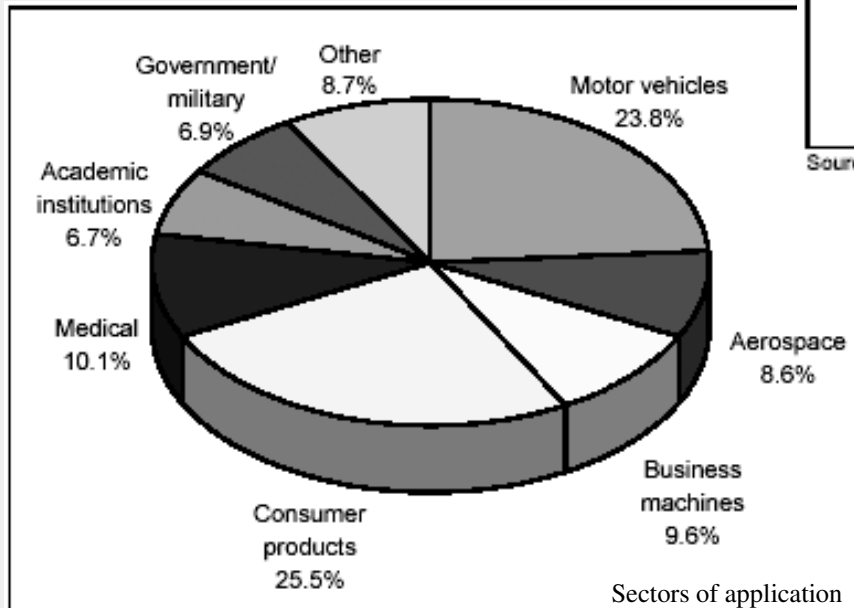

Useful Conditions for RP

- Single unique item or small number of copies needed
- Shape of object is in computer form
- Shape is too complex to be economically generated using conventional methods

Rapid Prototyping Technologies

- Six basic commercial technologies:

StereoLithography (SL)

Laminated Object Manufacturing (LOM)

Selective Laser Sintering (SLS)

Fused Deposition Modeling (FDM)

Solid Ground Curing (SGC)

Inkjet technologies (3D Plotting, MJM, 3DP..)

Rapid Prototyping Examples

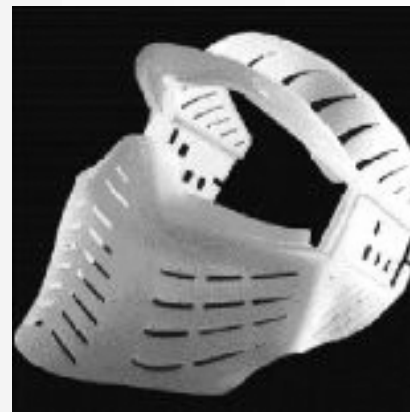
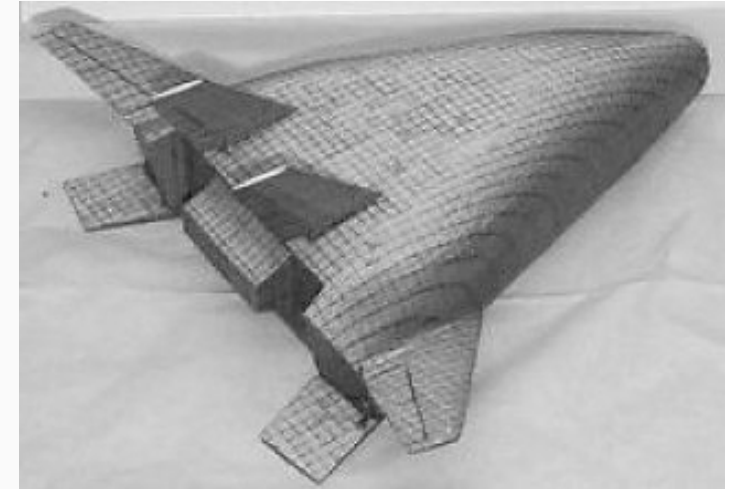
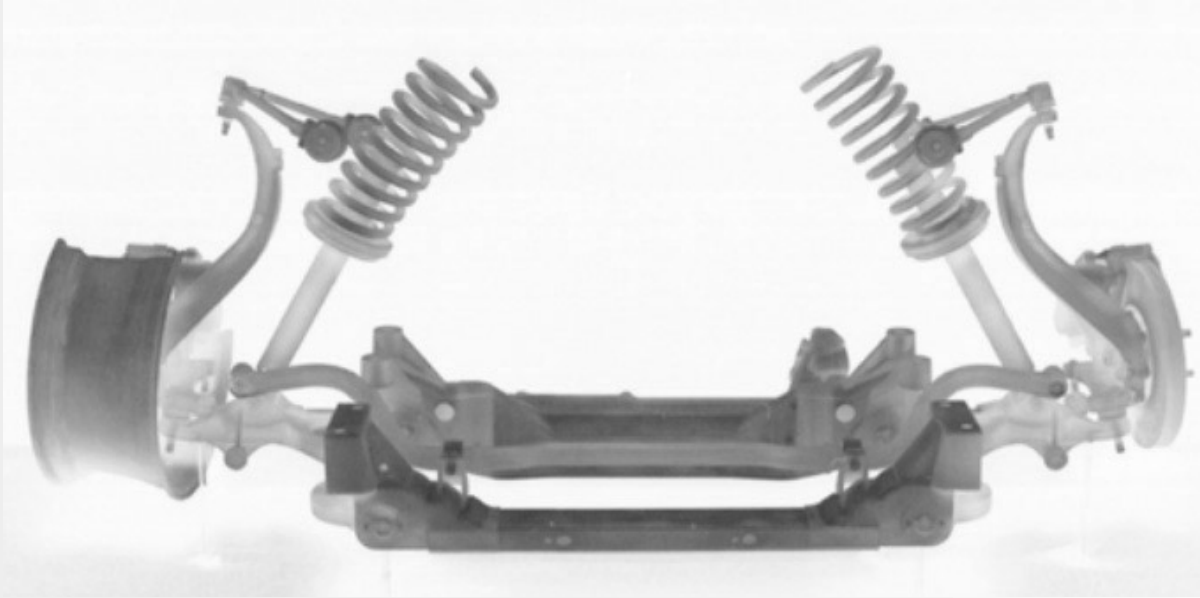

Examples of parts made by rapid prototyping processes.

Rapid Prototyping Examples / 2

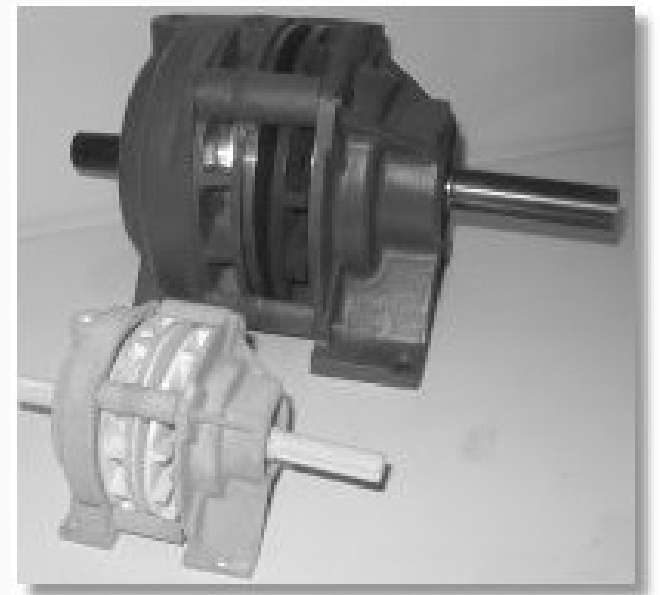
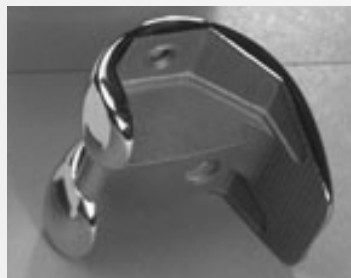

Characteristics of Rapid Prototyping Technologies

TABLE

Supply phase	Process	Layer creation technique	Phase change type	Materials
Liquid	Stereolithography	Liquid layer curing	Photopolymerization	Photopolymers (acrylates, epoxies, colorable resins, filled resins)
	Solid-based curing	Liquid layer curing and milling	Photopolymerization	Photopolymers
	Fused-deposition modeling	Extrusion of melted polymer	Solidification by cooling	Polymers (ABS, polyacrylate, etc.), wax, metals and ceramics with binder.
	Ballistic-particle manufacturing	Droplet deposition	Solidification by cooling	Polymers, wax
Powder	Three-dimensional printing	Layer of powder and binder droplet deposition	No phase change	Ceramic, polymer and metal powders with binder.
	Selective laser sintering	Layer of powder	Laser driven sintering melting and solidification	Polymers, metals with binder, metals, ceramics and sand with binder.
Solid	Laminated-object manufacturing	Deposition of sheet material	No phase change	Paper, polymers.

The Most Important Commercial Rapid Prototyping Technologies at a Glance

Technology >>	Stereo-lithography	Stereo-lithography	Wide Area Thermal Inkjet	Selective Laser Sintering	Fused Deposition Modeling	Single Jet Inkjet	Three Dimensional Printing	Laminated Object Manufacturing
Acronym >>	SLA	SLA	MJM	SLS	FDM	MM	3DP	LOM
Representative Vendor >>	Sony	3D Systems			Stratasys	SolidScape	Z Corp.	Cubic Technologies
General Qualitative Features								
Maximum Part Size (inches)	39 x 31 x 20	20 x 20 x 24	10 x 8 x 8	15 x 13 x 18	24 x 20 x 24	12 x 6 x 9	20 x 24 x 16	32 x 22 x 20
Speed	very good (uses dual beams for approx. 2X speed-up)	average	good	average to fair	poor	poor	excellent	good
Accuracy	very good	very good	good	good	fair	excellent	fair	fair
Surface Finish	very good	very good	fair	fair	fair	excellent	fair	fair to poor (depending on application)
Strengths	very large part size, accuracy speed	large part size, accuracy	office OK	accuracy, materials,	office OK price, materials	accuracy, finish, office OK	speed, office OK, price, color, price	large part size, good for large castings, material cost
Weaknesses	post processing, messy liquids	post processing, messy liquids	size and weight, fragile parts, limited materials, part size	size and weight, system price, surface finish	speed	speed, limited materials, part size	limited materials, fragile parts, finish	part stability, smoke finish and accuracy

Stereolithography SL

- 3D Systems, Valencia, CA
- patent 1986, *beginning of RP*
- photopolymerization using UV laser
- accuracy 0.025 mm
- epoxies, acrylates

Stereolithography SL

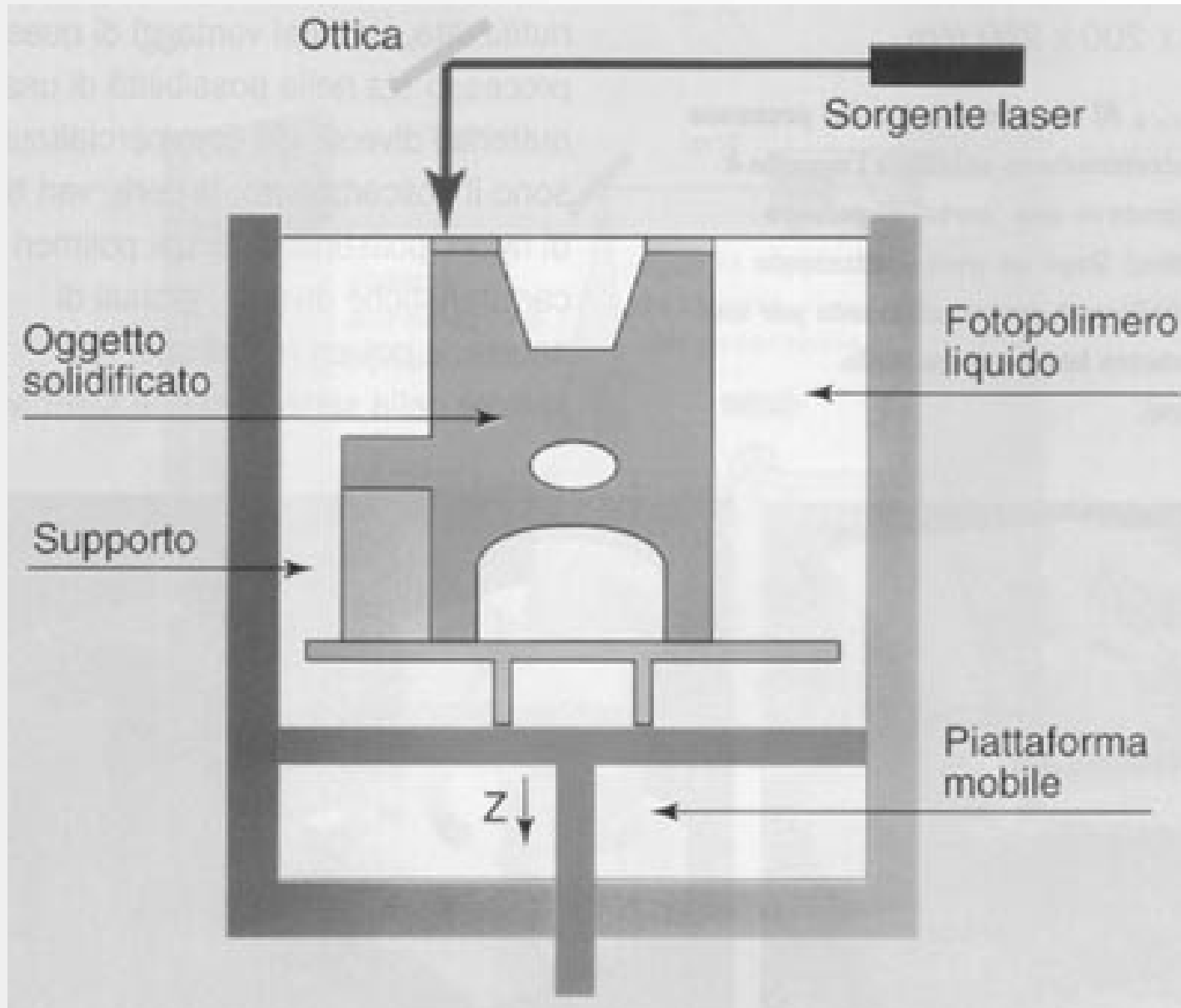

Stereolithography

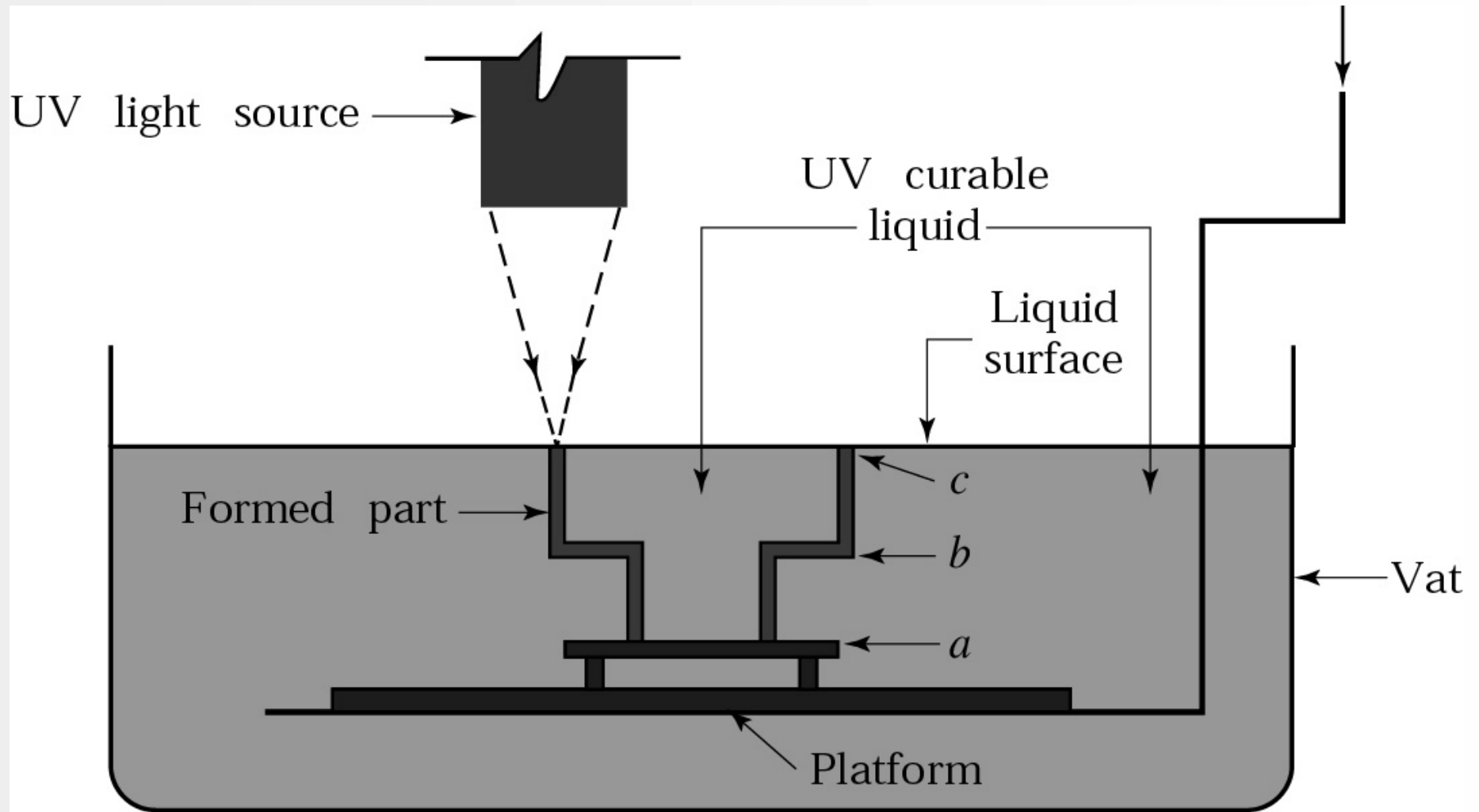

Schematic illustration of the stereolithography process. *Source:* Ultra Violet Products, Inc.

Stereolithography SL

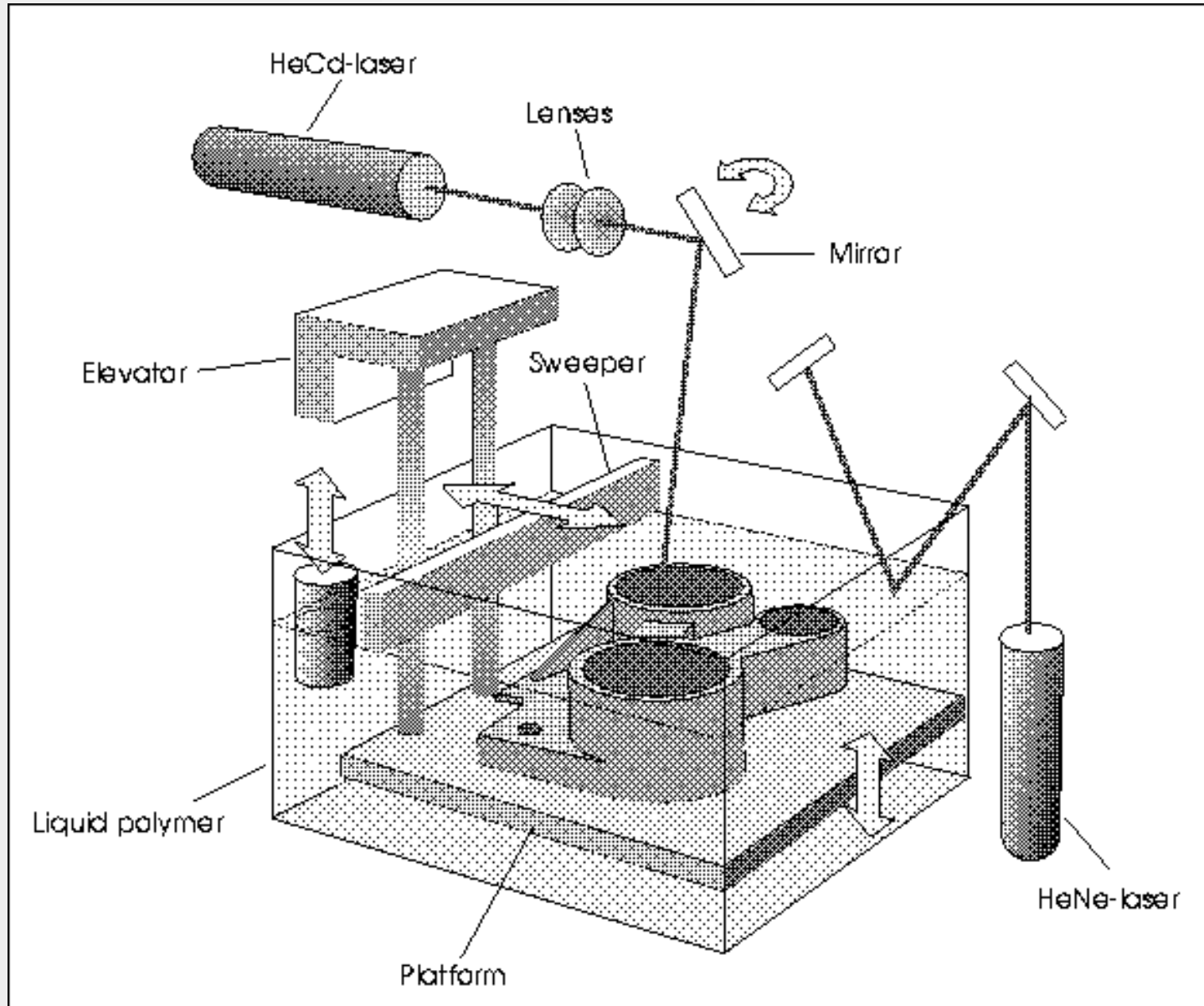

Stereolithography Machines

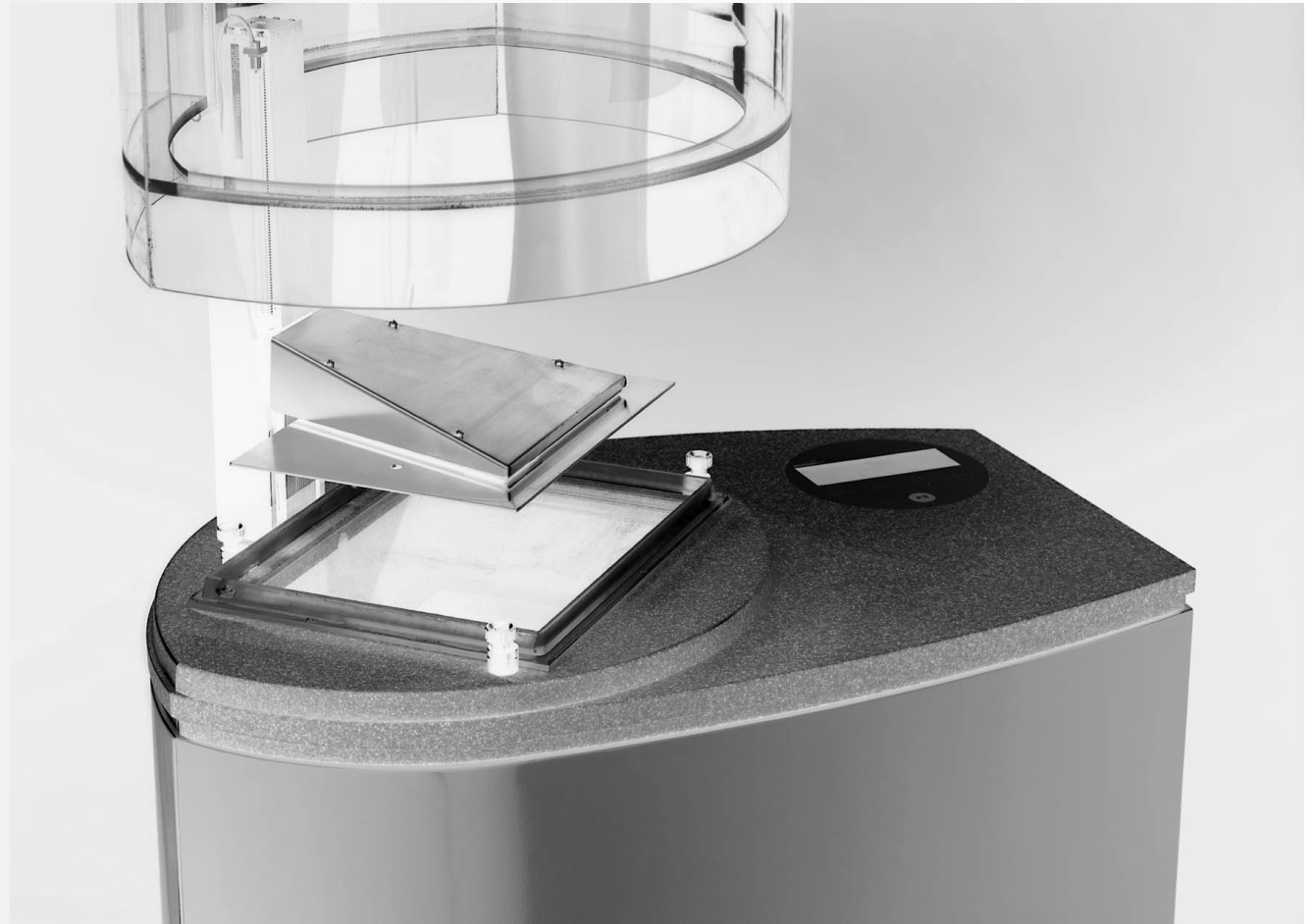

Stereolithography Process

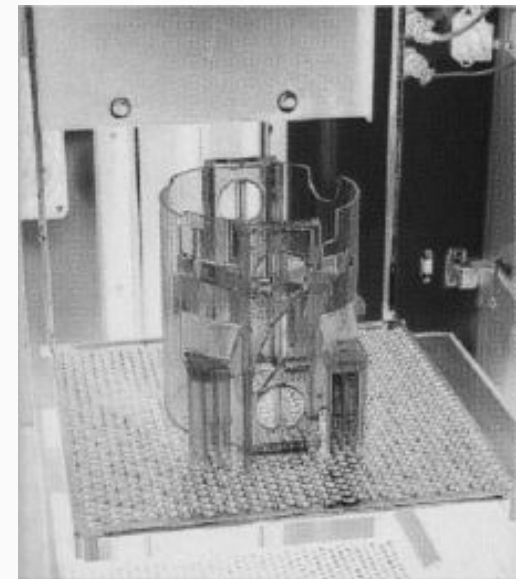
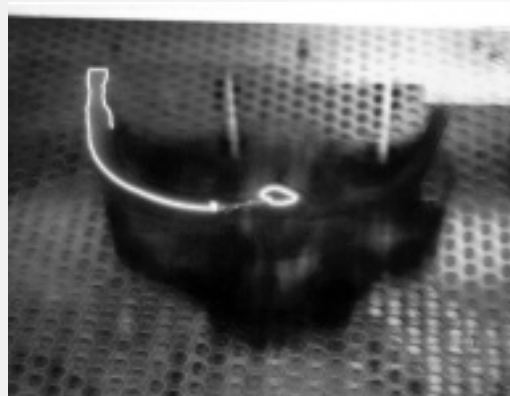
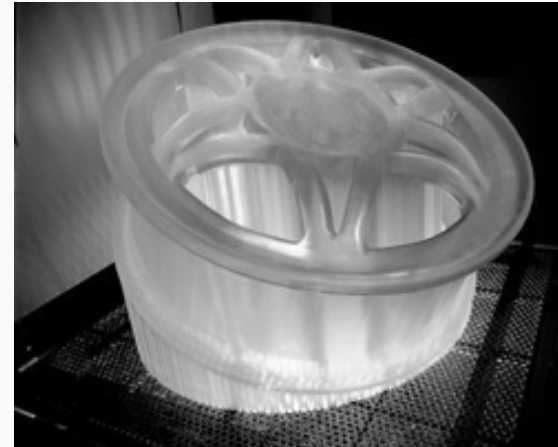
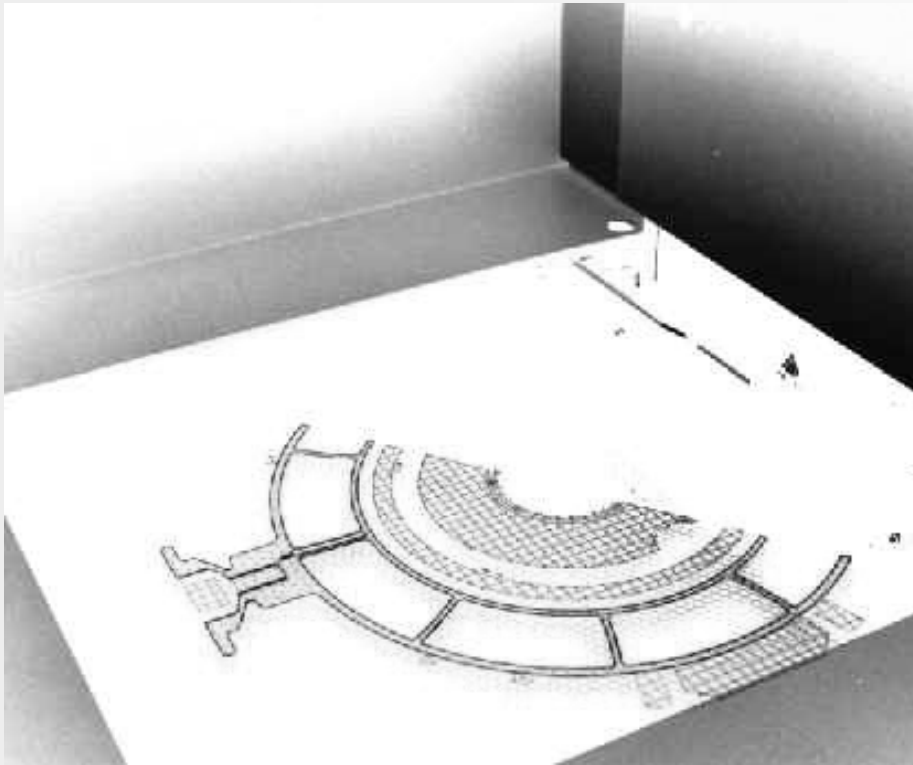

SL Applications

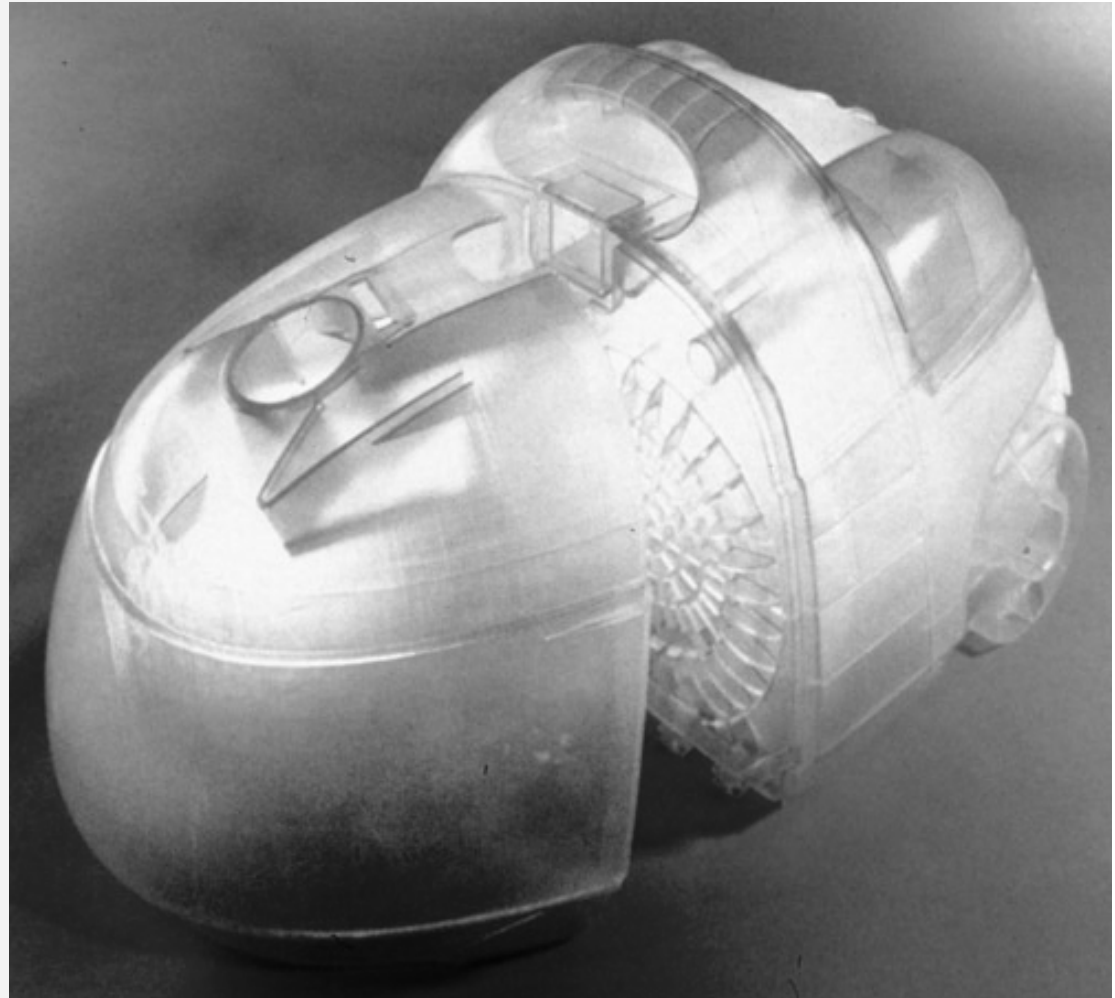
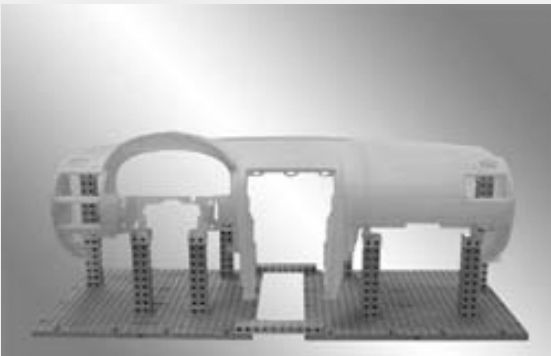

SL Applications

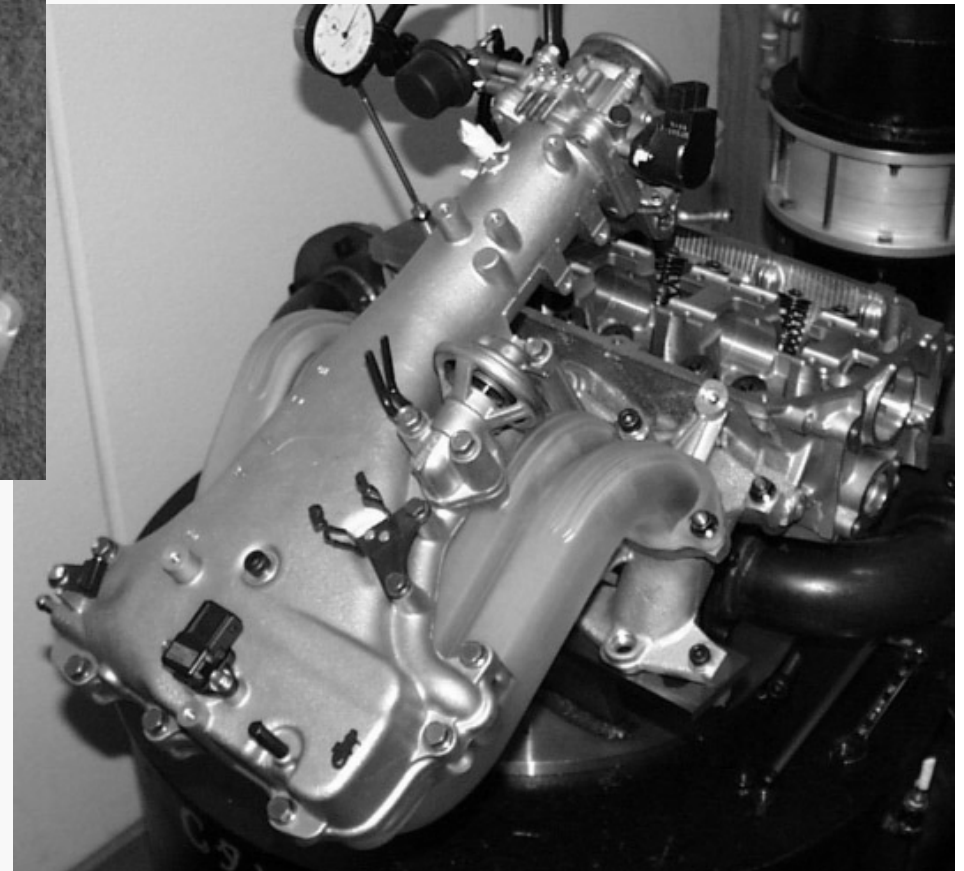

Stereo-lithography

The computational steps in producing a stereolithography file.

- a) Three-dimensional description of part.
- b) The part is divided into slices (only one in 10 is shown).
- c) Support material is planned.
- d) A set of tool directions is determined to manufacture each slice.

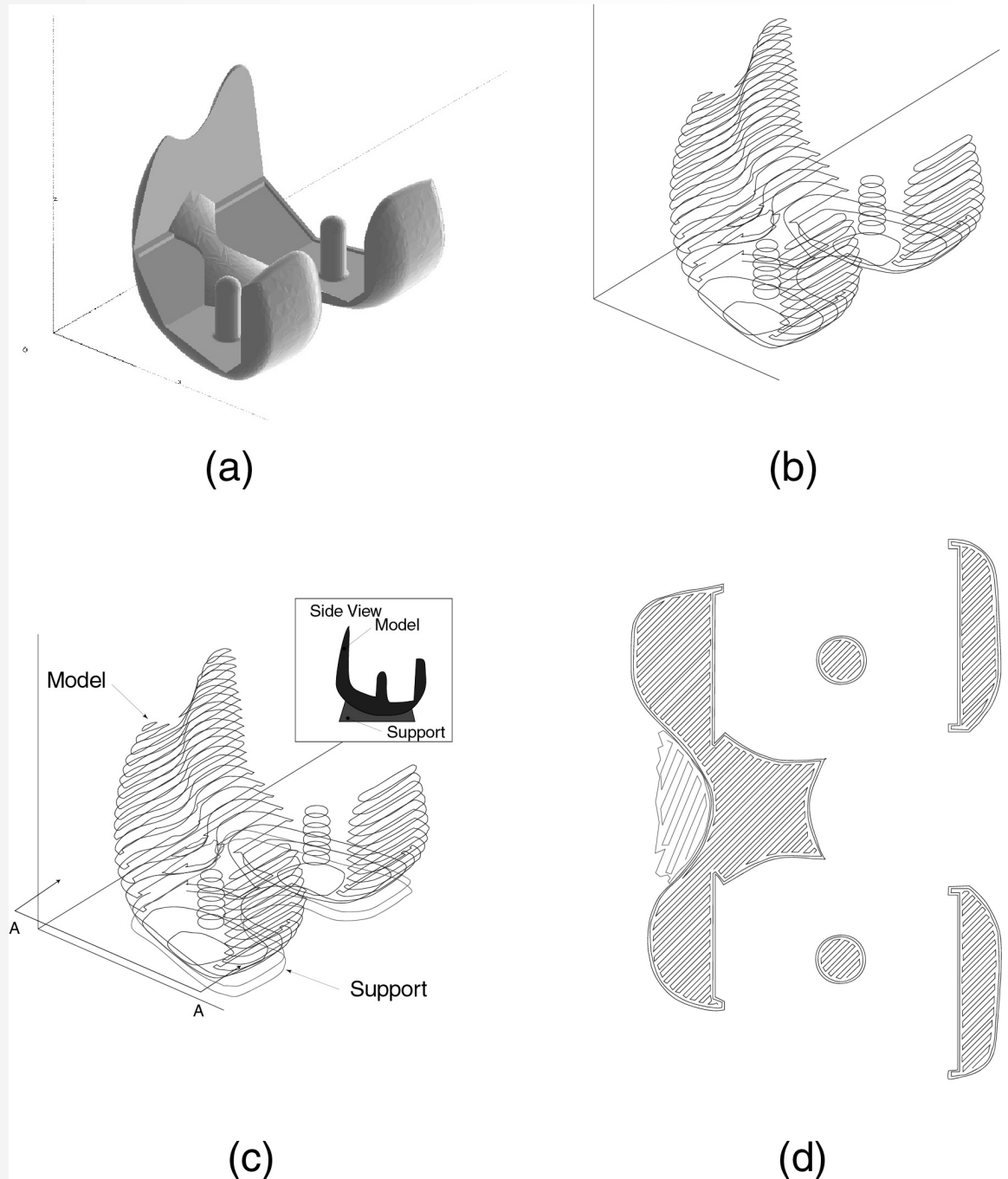

RP Sequence

- CAD solid model
- '.STL' file
- Slicing the file
- Final build file
- Fabrication of part
- Post processing

CAD Solid Model

- Solid model or closed surface model required

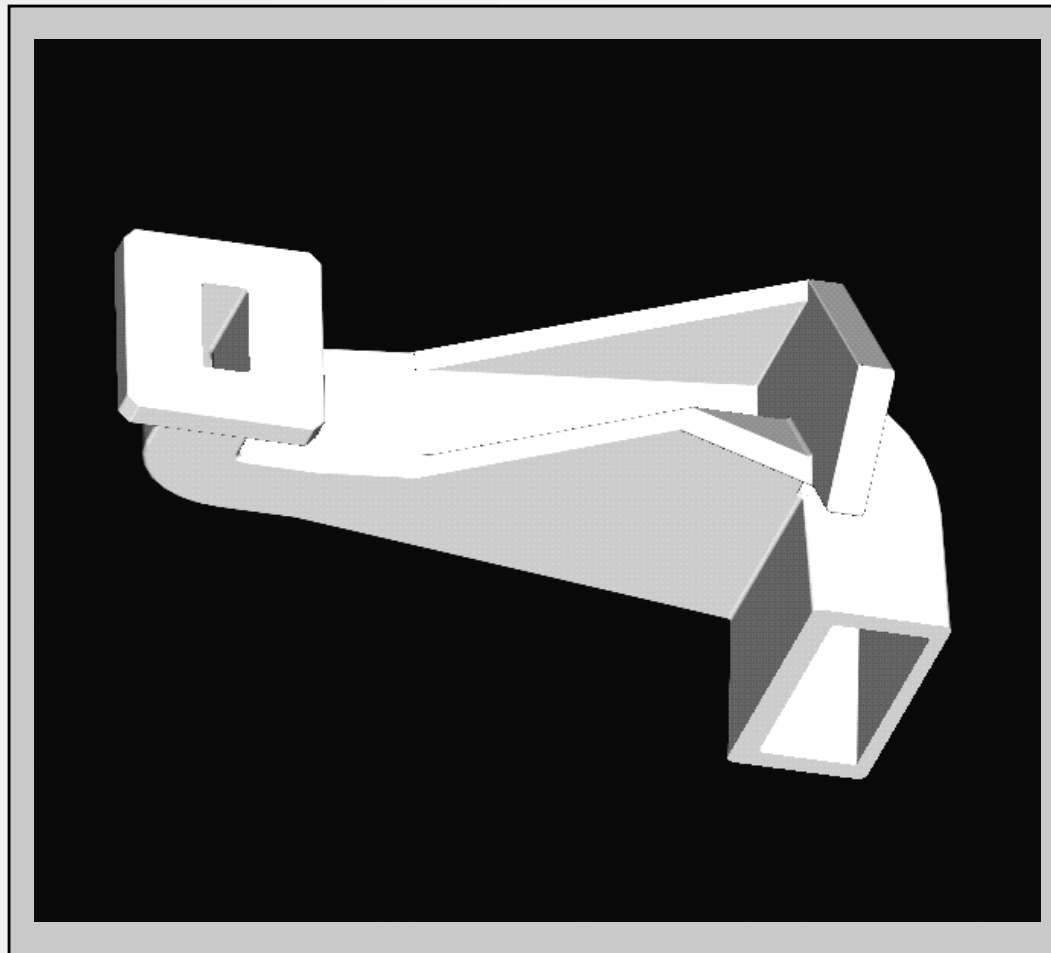

‘.STL’ File

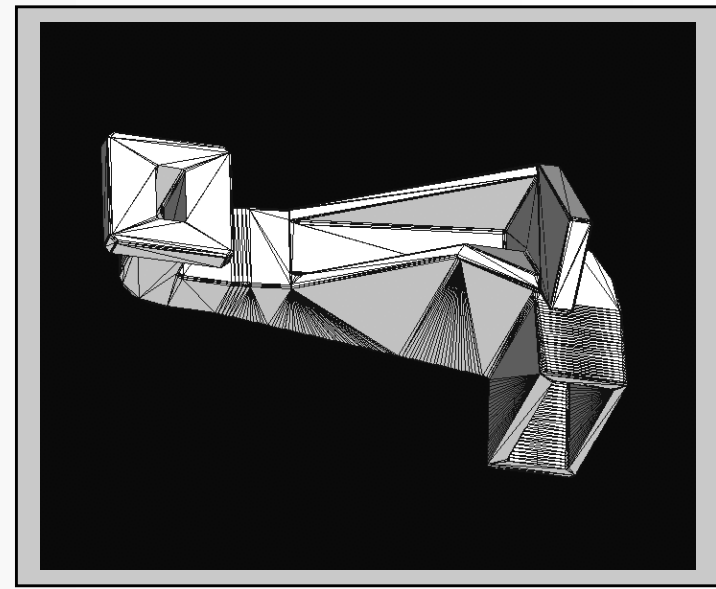

- Software generates a tessellated object description
- File consists of the X, Y, Z coordinates of the three vertices of each surface triangle, with an index to describe the orientation of the surface normal
- Support generation to hold overhung surfaces during build

Slicing the File

- Series of closely spaced horizontal planes are mathematically passed through the .stl file
- Generate a '.sli' file : a series of closely spaced 2D cross-sections of the 3D object
- Typical Z thickness 0.006" (0.150 mm)
- Other Parameters chosen =fn(RP technology)

Common Support Structures

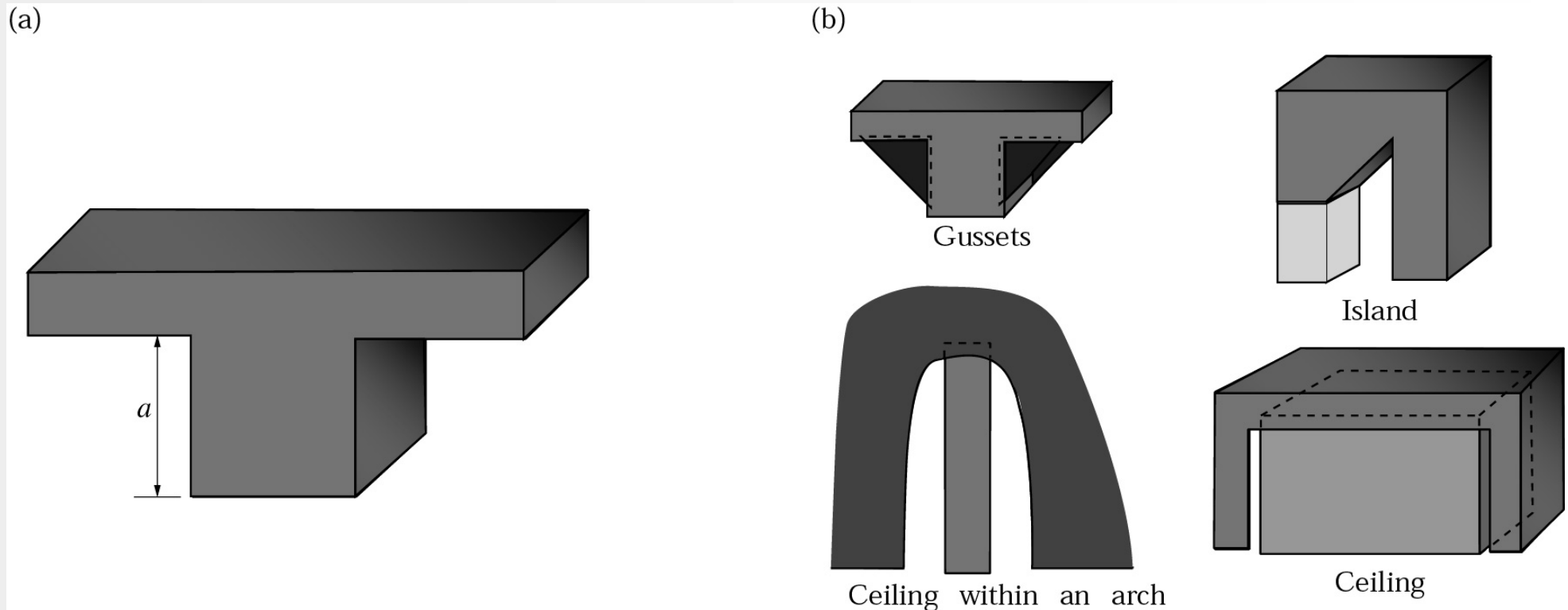

- (a) A part with a protruding section which requires support material.
(b) Common support structures used in rapid-prototyping machines.

Source: P.F. Jacobs, *Rapid Prototyping & Manufacturing: Fundamentals of Stereolithography*. Society of Manufacturing Engineers, 1992.

Final Build File

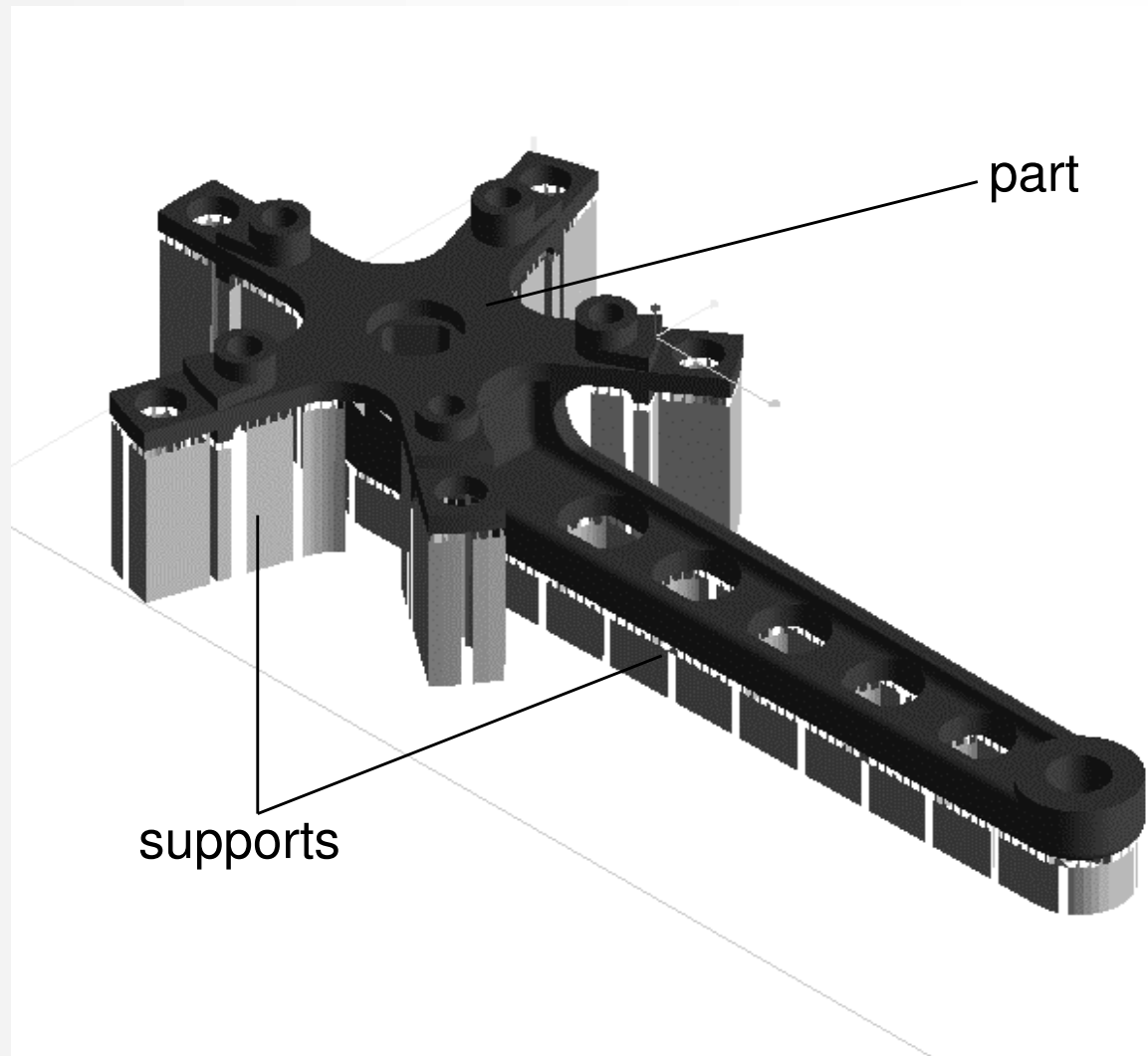

Part sliced

Supports sliced

RP technology parameters set (layer thickness, scan speed,...)

Send file to RP machine

Fabrication of Part

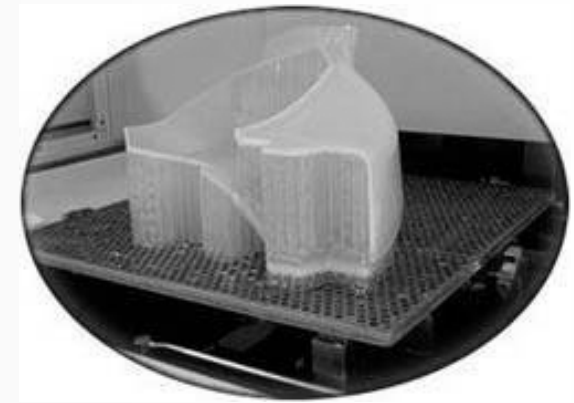
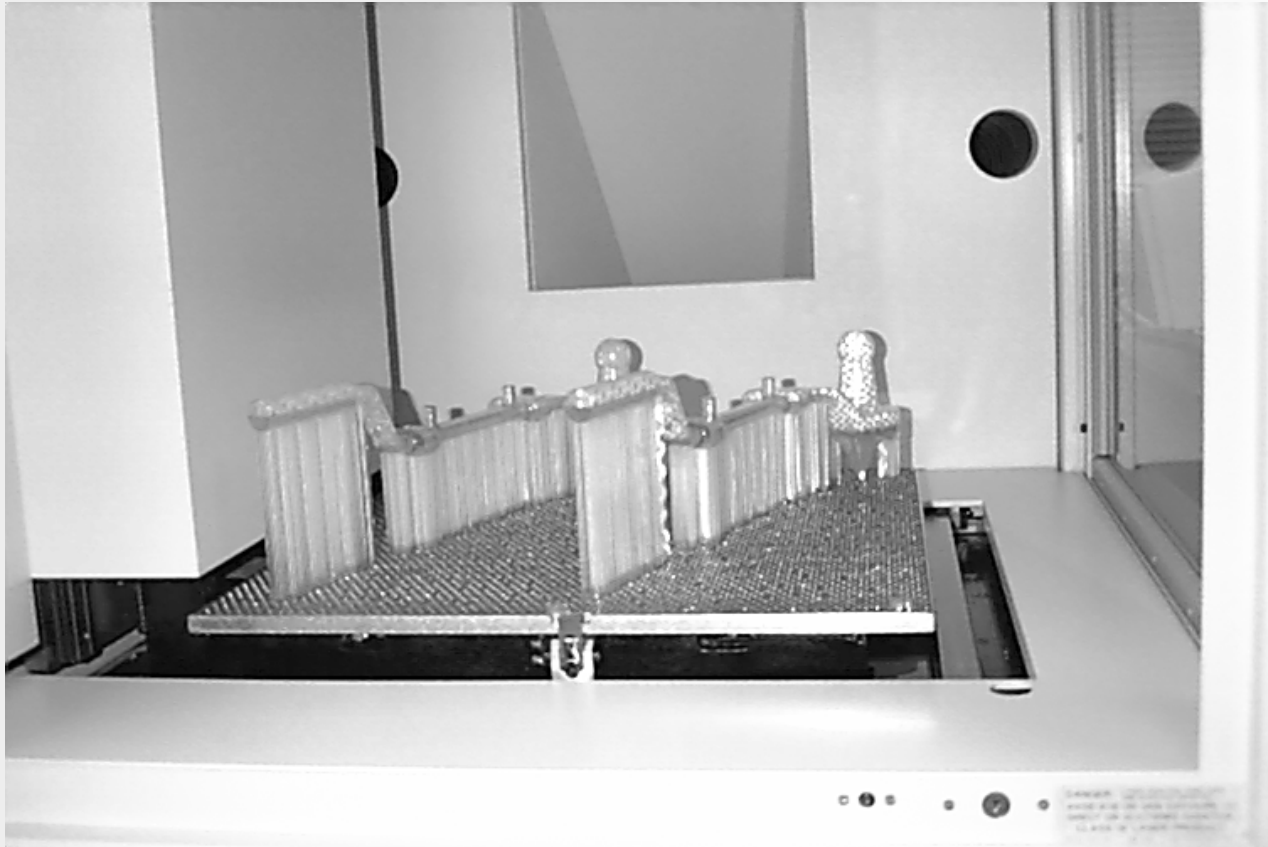

**Models built on stereolithography apparatus.
Part and supports shown attached to platform.**

Post-processing

Removal of part from platform

Removal of supports from part

Cleaning of part (wiping, rinsing, ...)

Finishing part (sanding, polishing, ...)

Laminated Object Manufacturing LOM

- Cubic Technologies, Carson, CA (former Helisys)
- patent 1985
- cross-sectional cutouts fused together
- accuracy 0.076 mm
- paper, plastic

Laminated Object Manufacturing LOM

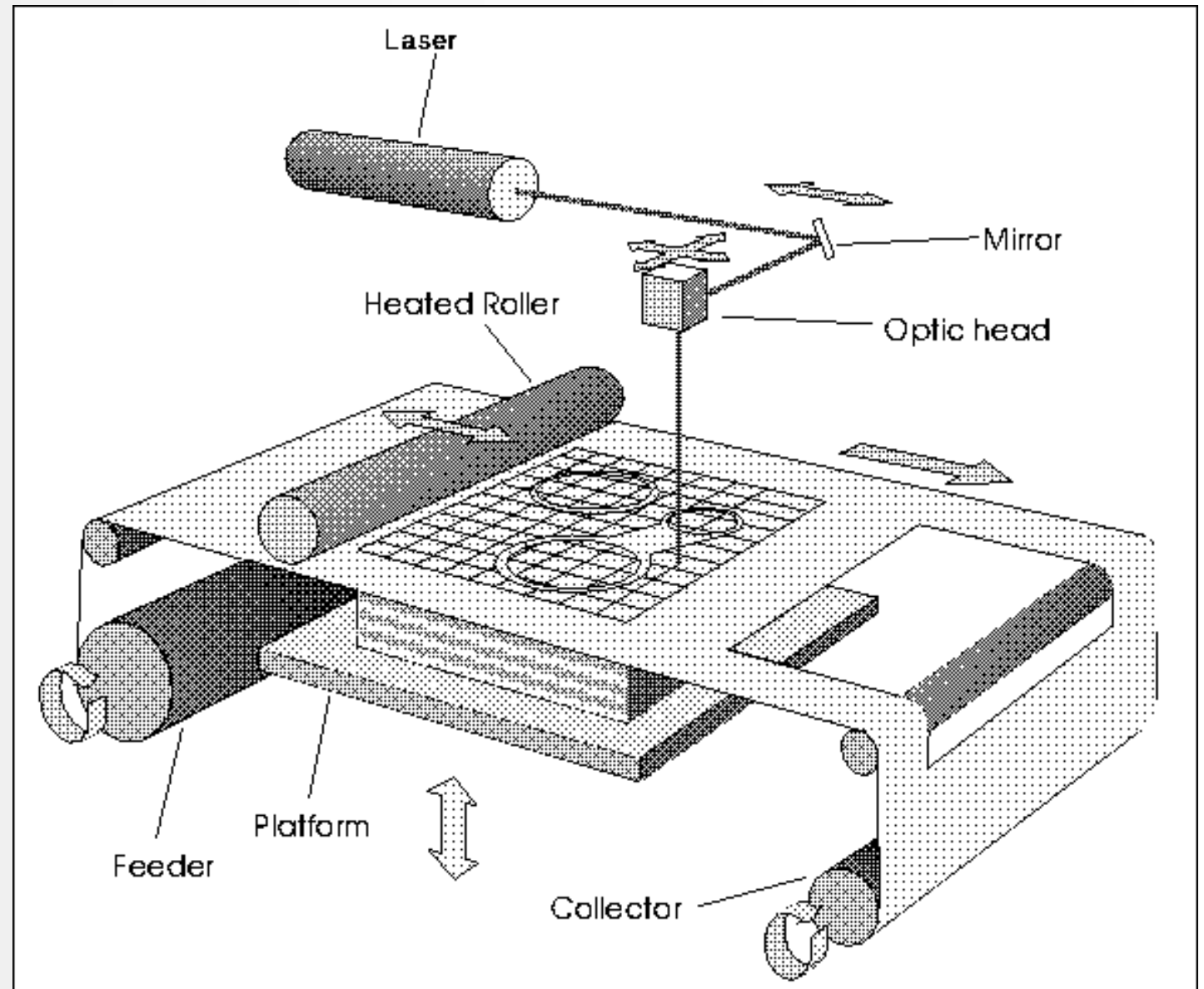
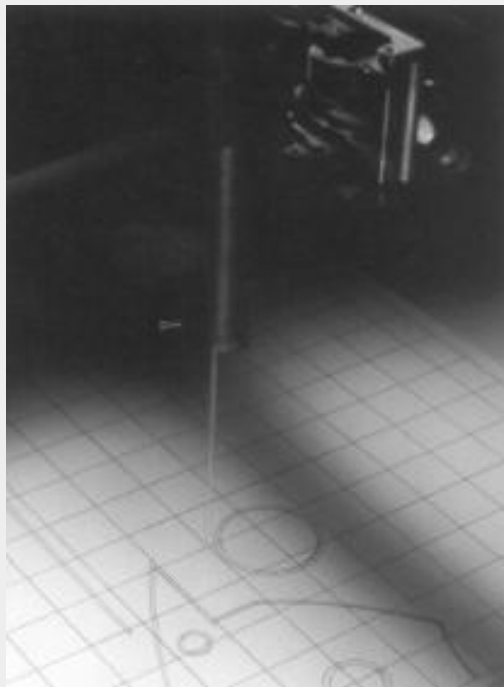

Laminated Object Manufacturing LOM

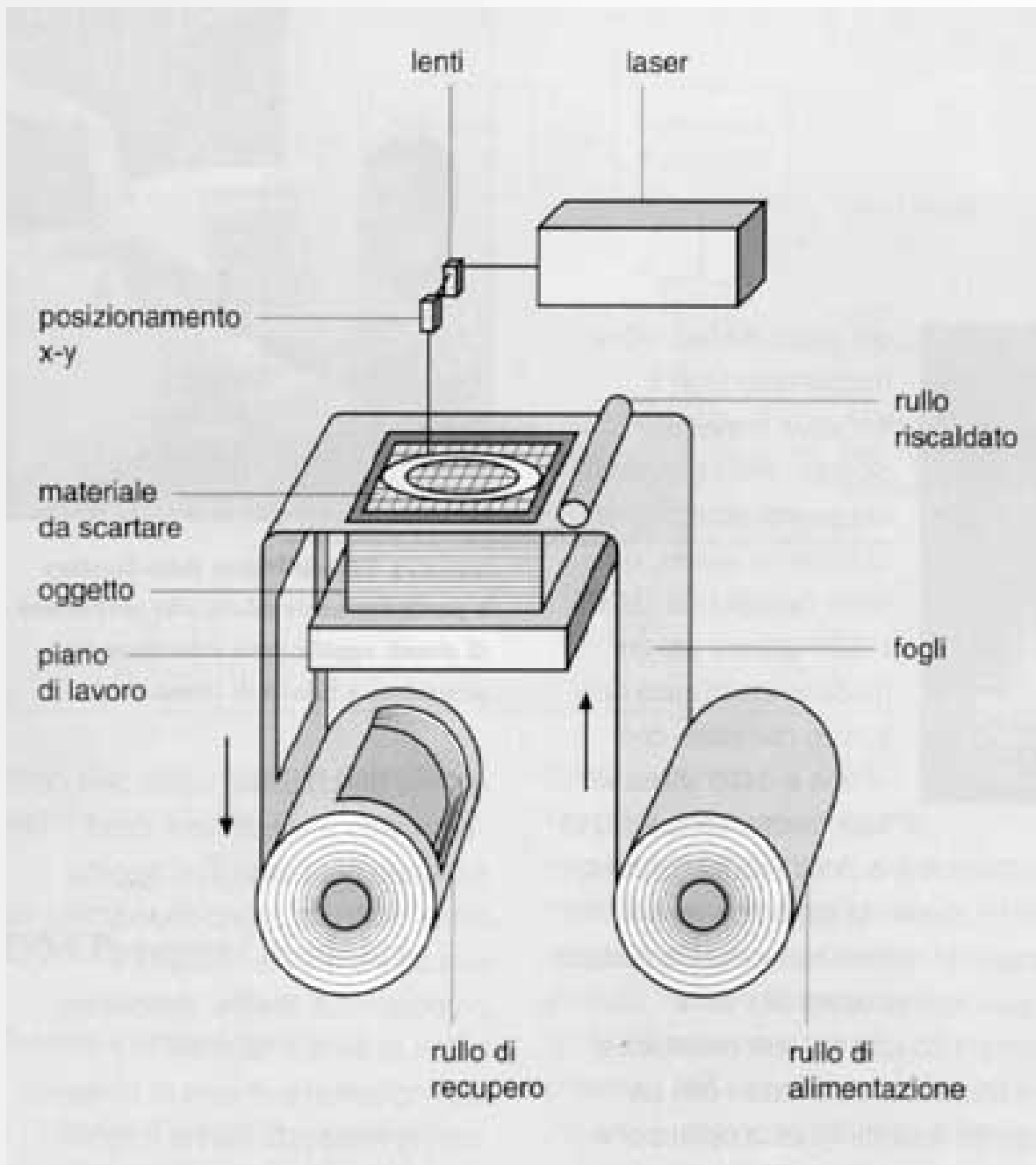

Laminated-Object Manufacturing

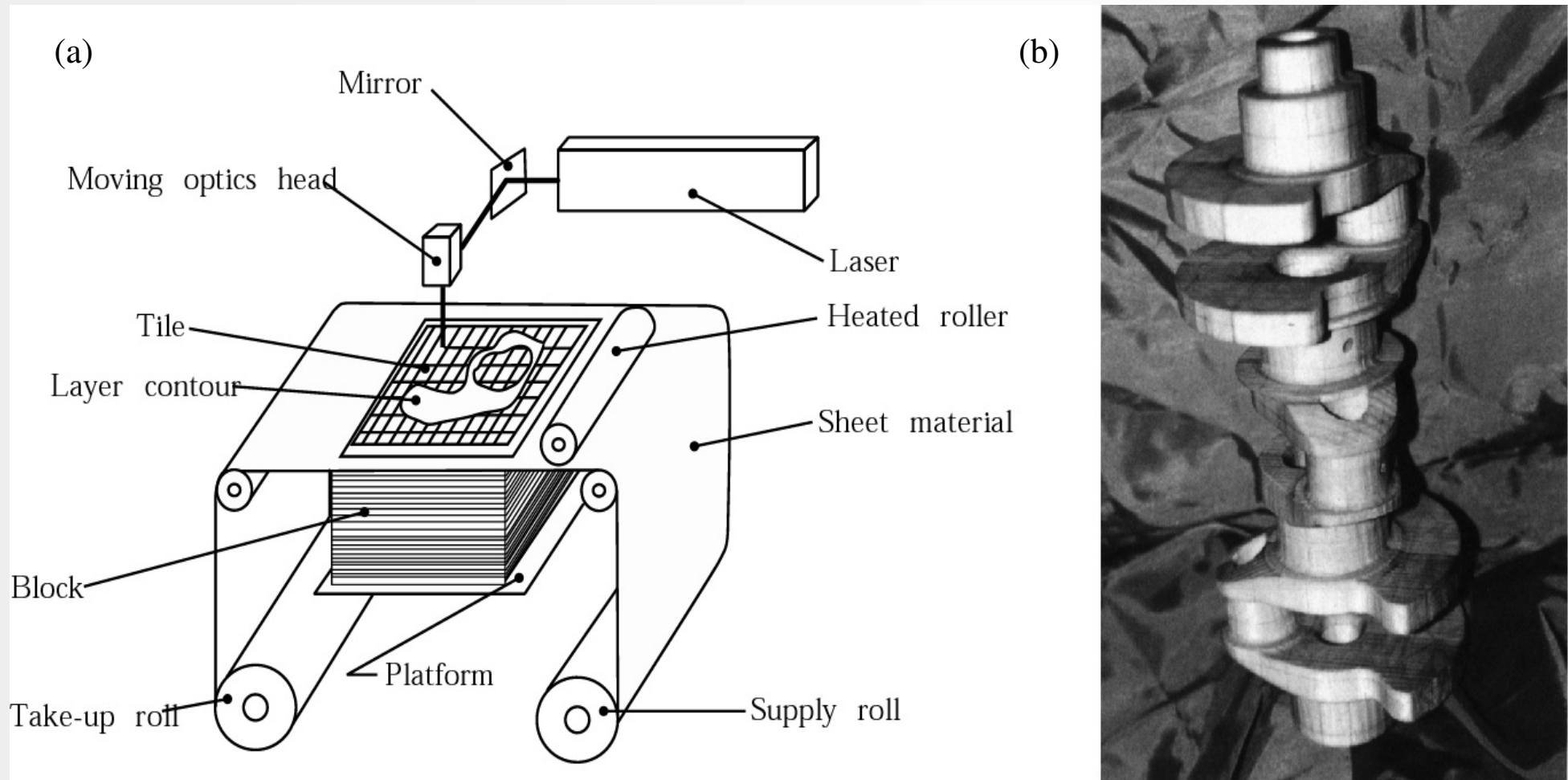

- (a) Schematic illustration of the laminated-object-manufacturing process. *Source:* Helysis, Inc.
- (b) Crankshaft-part example made by LOM. *Source:* After L. Wood.

Helisys LOM 1015



LOM Applications

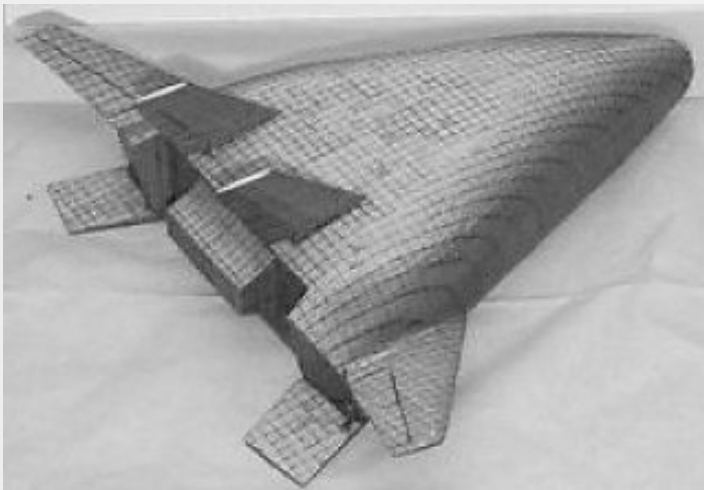
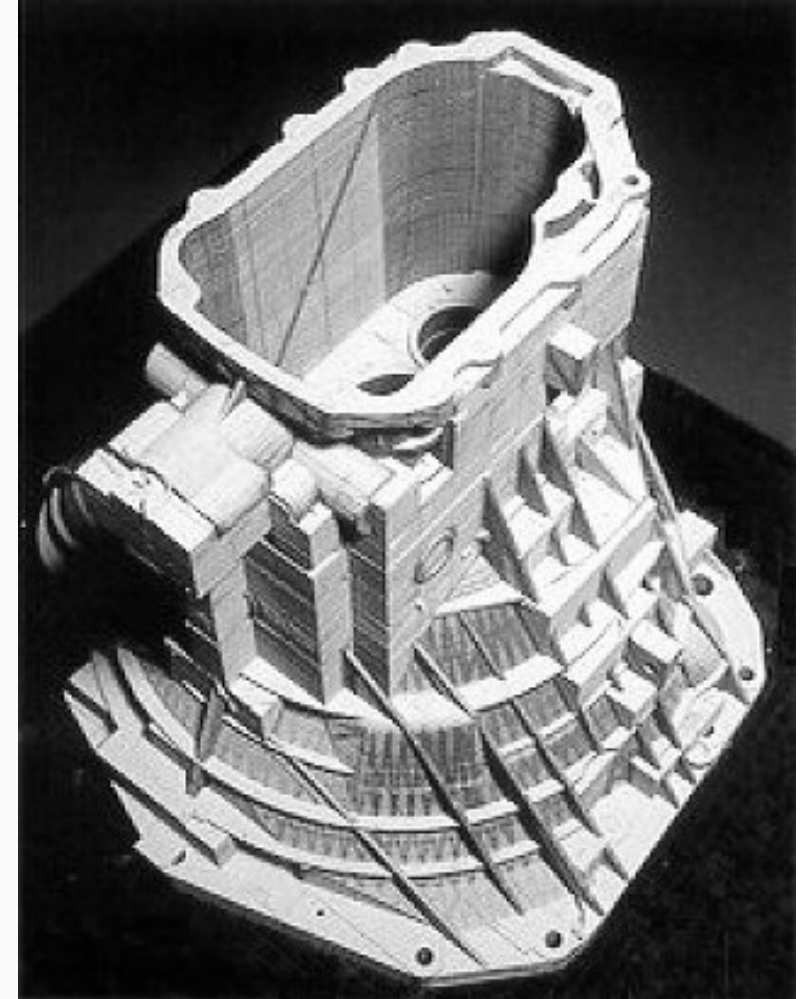
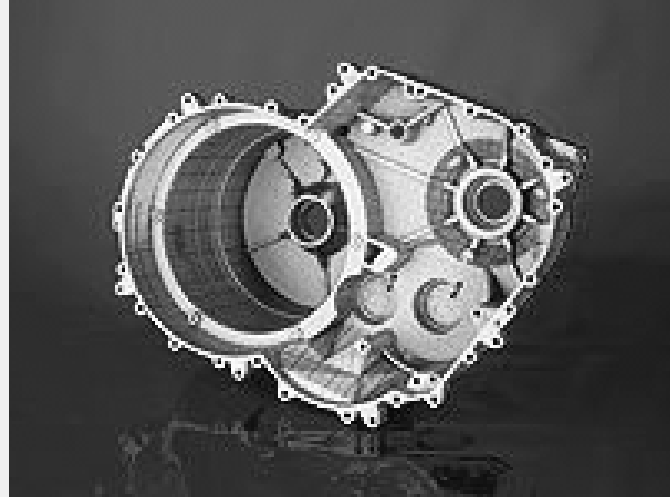
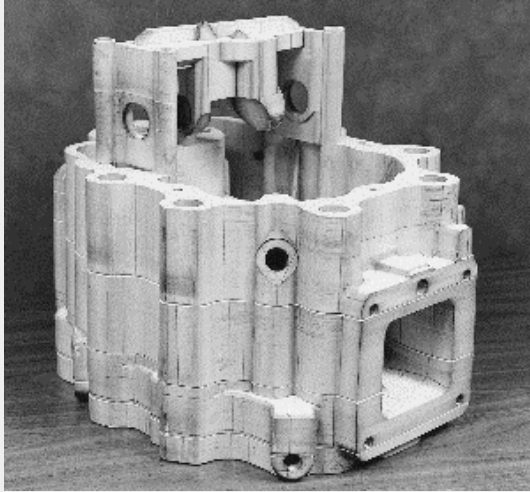

Selective Laser Sintering SLS

- 3D Systems, Valencia, CA (former DTM)
- patent 1989, Carl Deckard's master thesis
- fusing polymeric powders with CO2 laser
- accuracy 0.040 mm
- polycarbonate, nylon, wax, glass-filled nylon, powder coated metals or ceramics

Selective Laser Sintering

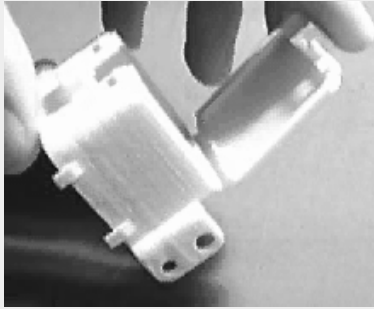

How the SLS System Works

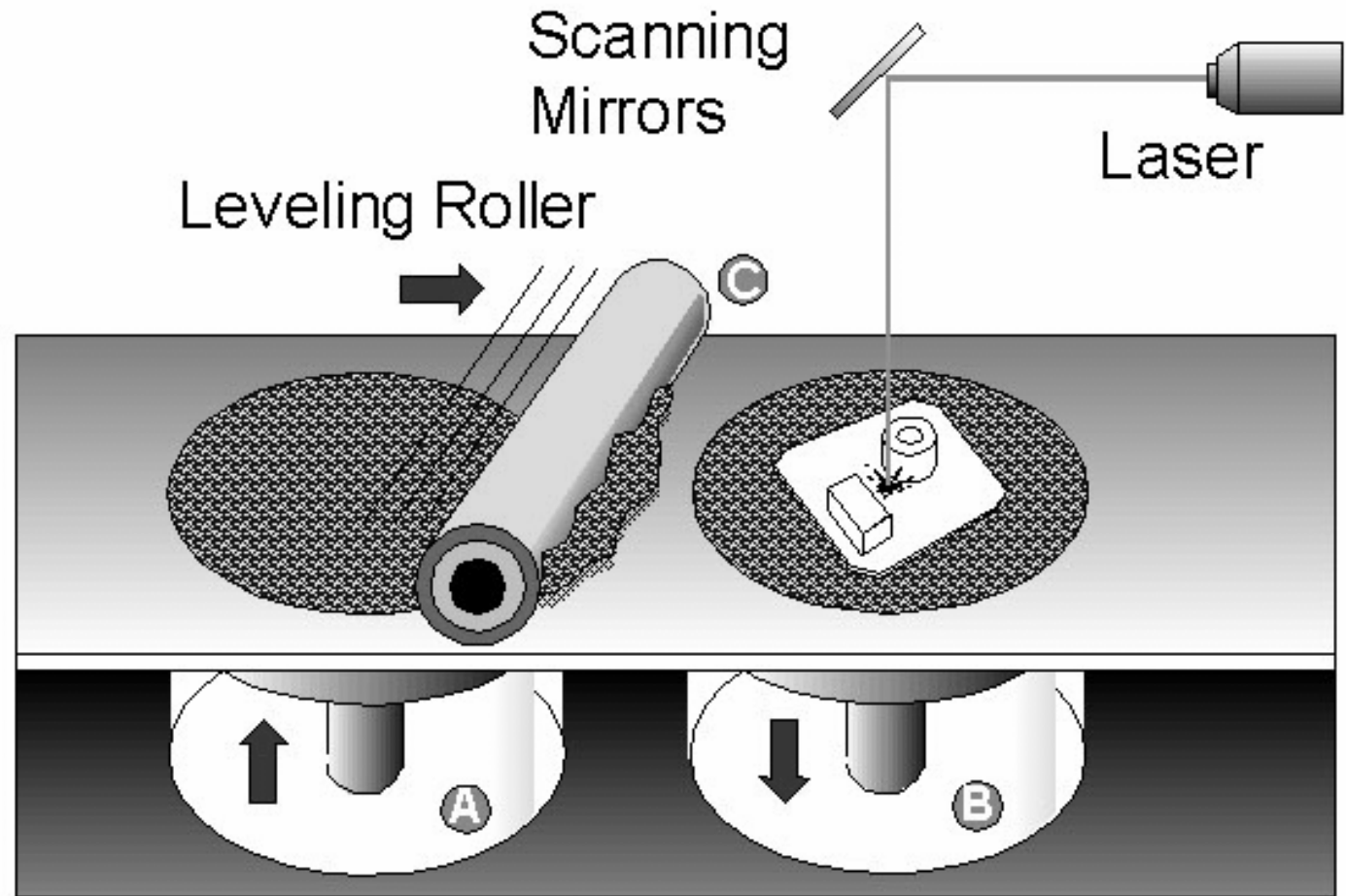

Selective Laser Sintering SLS

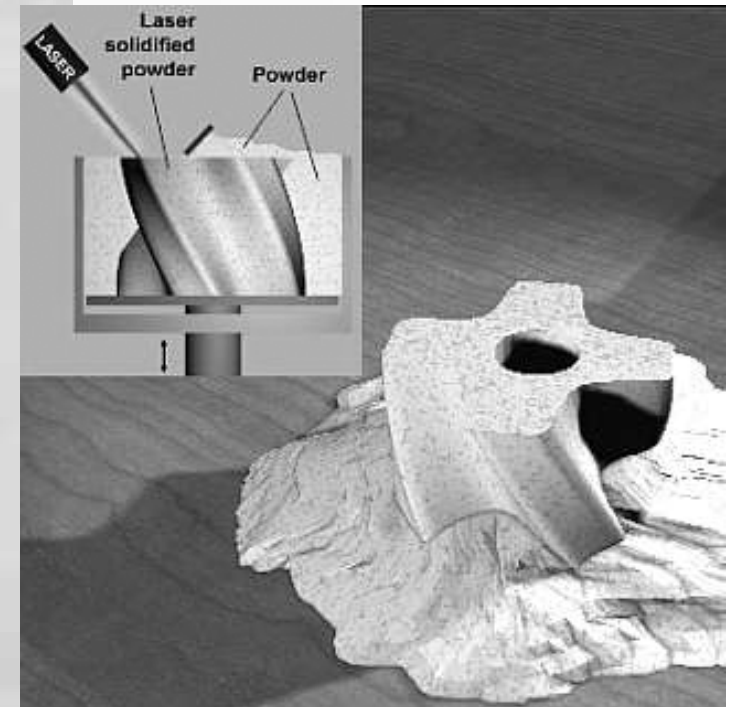
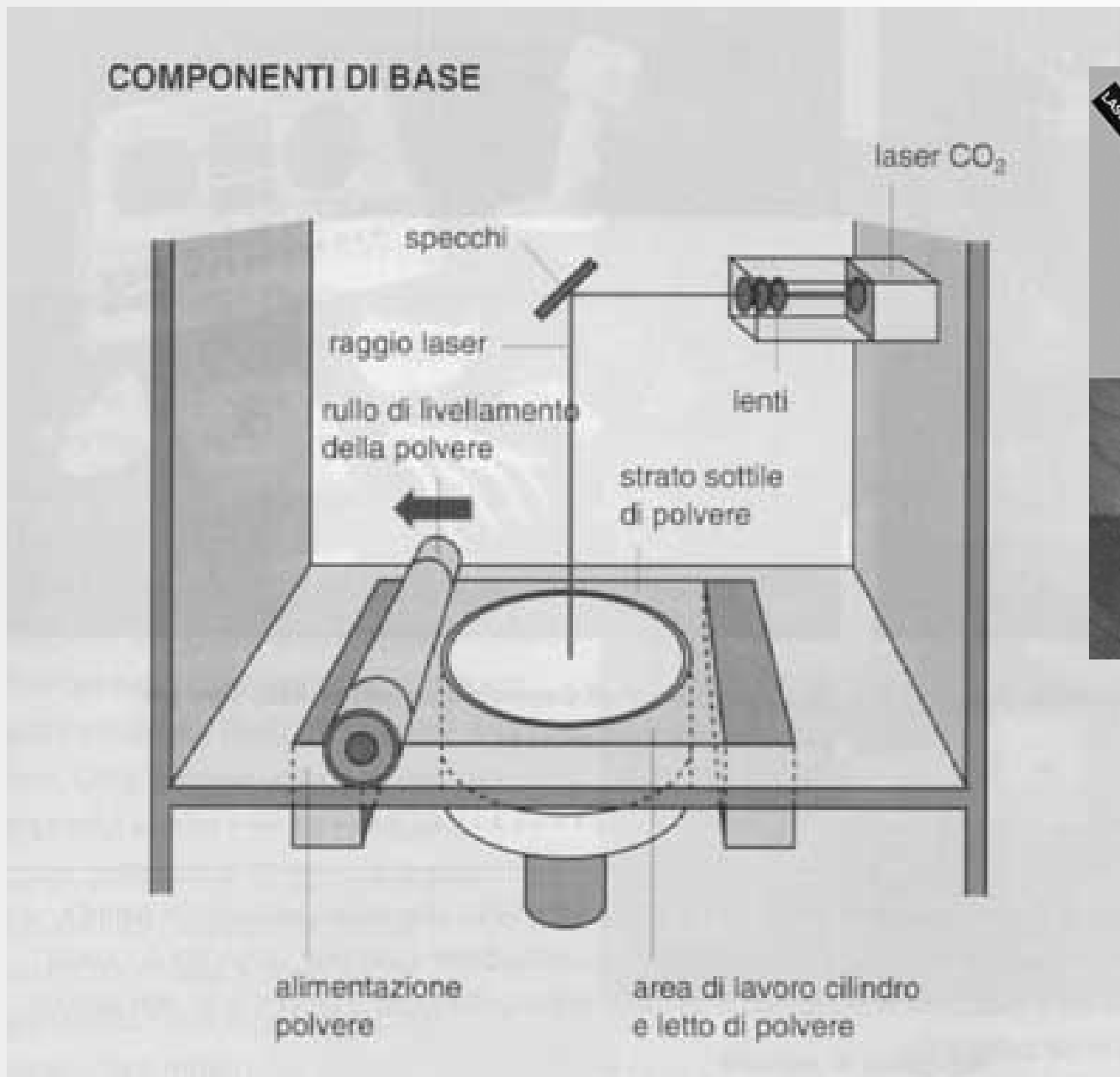

Selective Laser Sintering

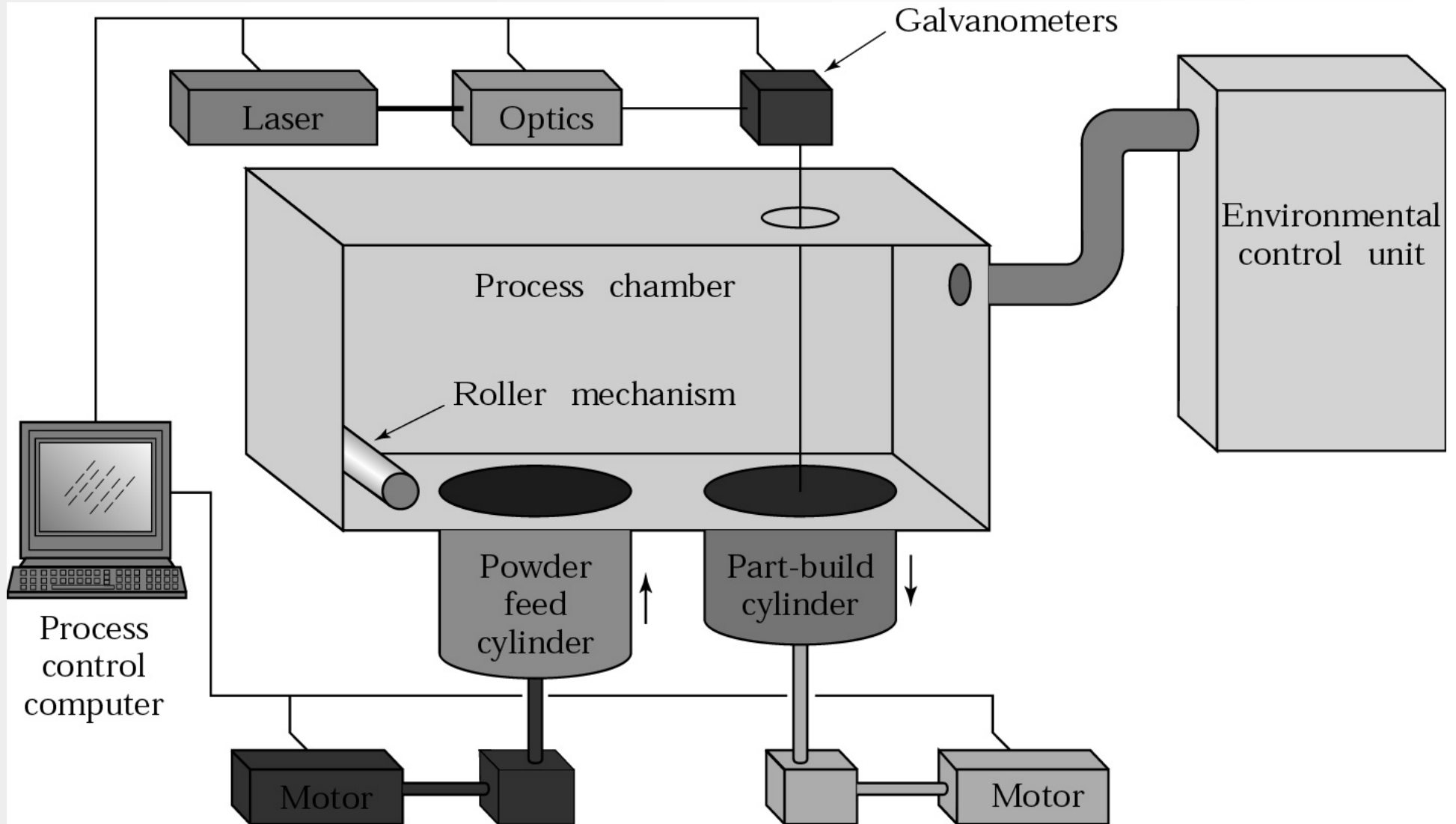

Schematic illustration of the selective laser sintering process. *Source:* After C. Deckard and P.F. McClure.

Selective Laser Sintering

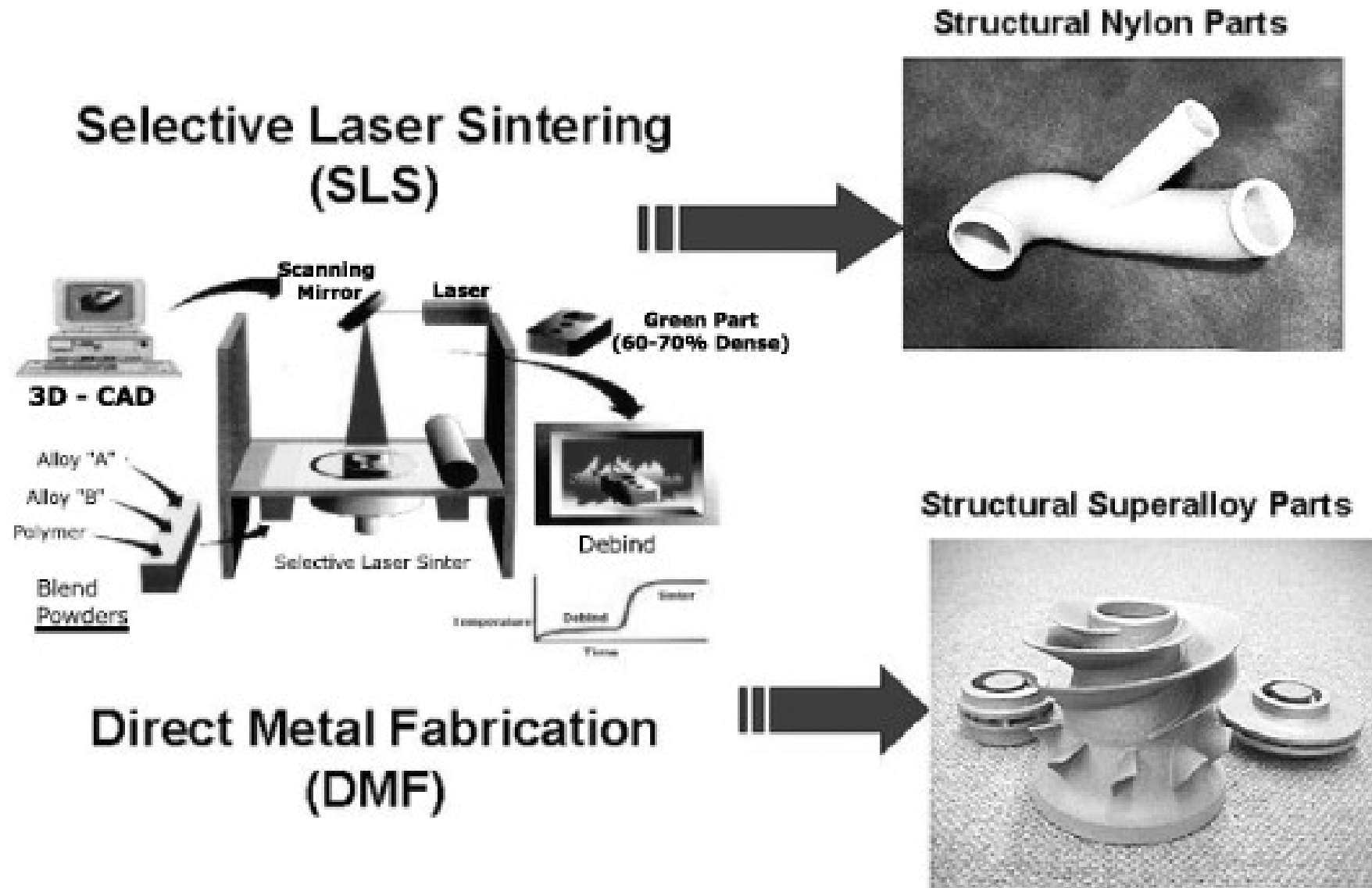

SLS Applications

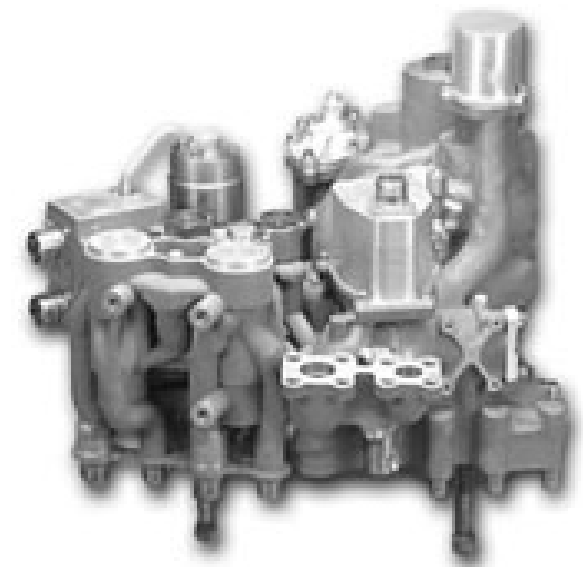
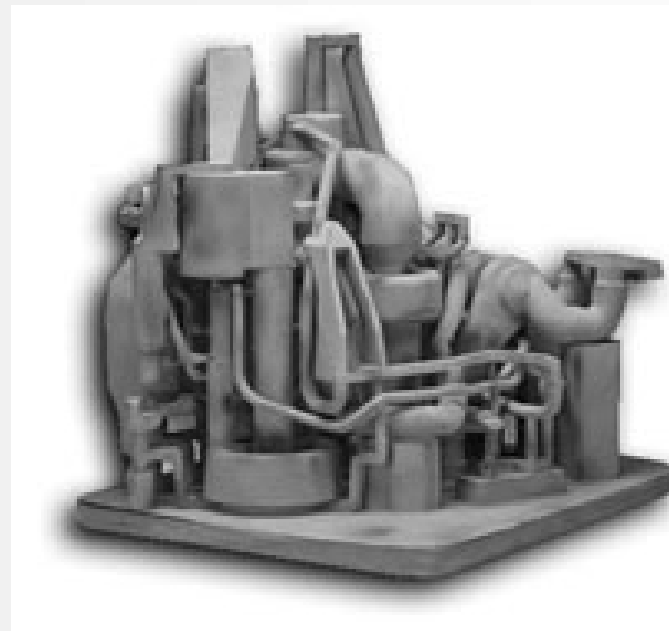
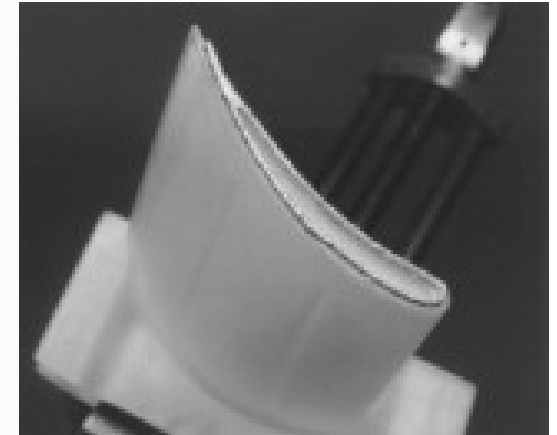
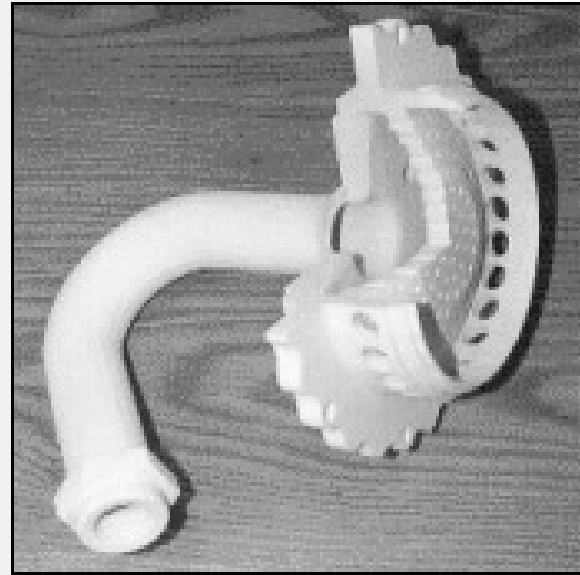

Fused Deposition Modeling

FDM

- Stratasys, Eden Prairie, MN
- patent 1992
- robotically guided fiber extrusion
- accuracy 0.127 mm
- casting and machinable waxes, polyolefin, ABS, PC

Fused Deposition Modeling

FDM

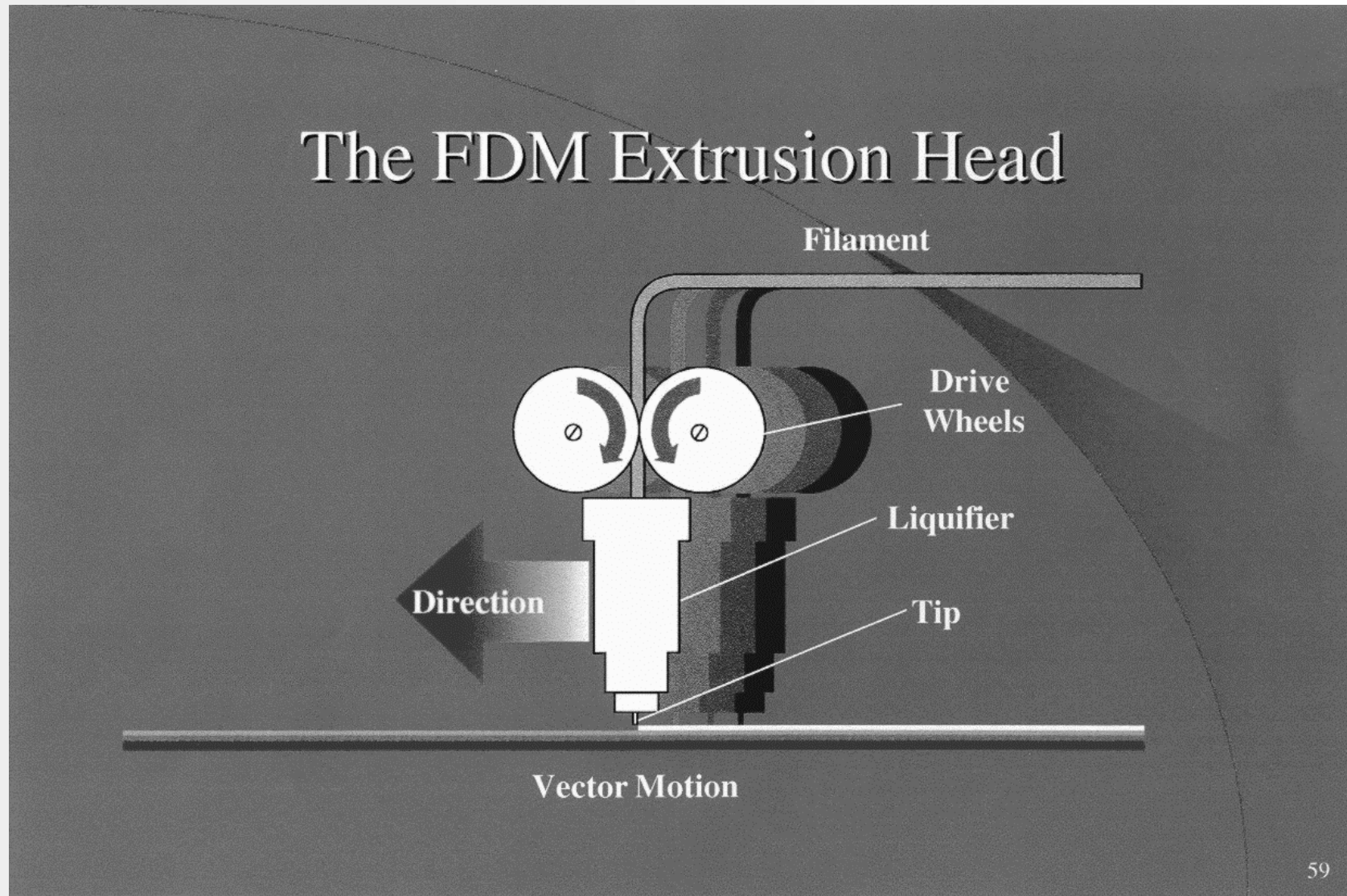

Fused Deposition Modeling FDM

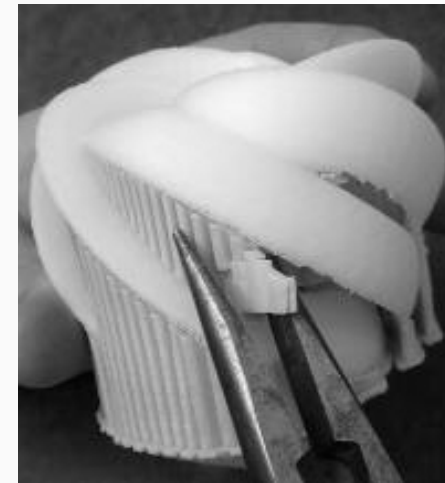
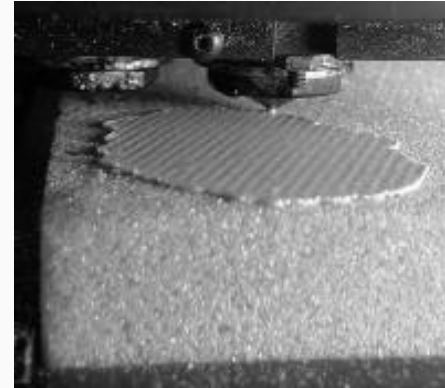
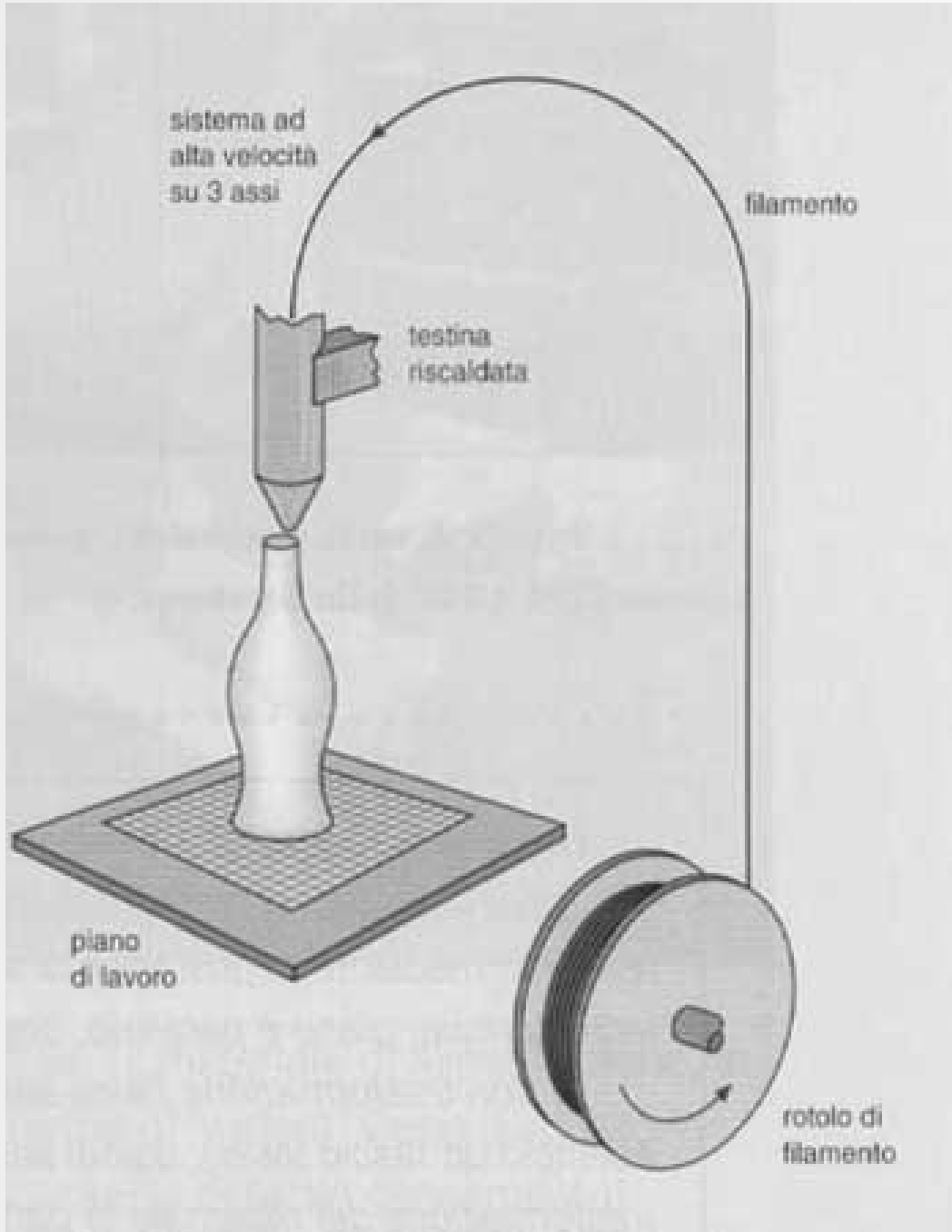

Fused-Deposition-Modeling

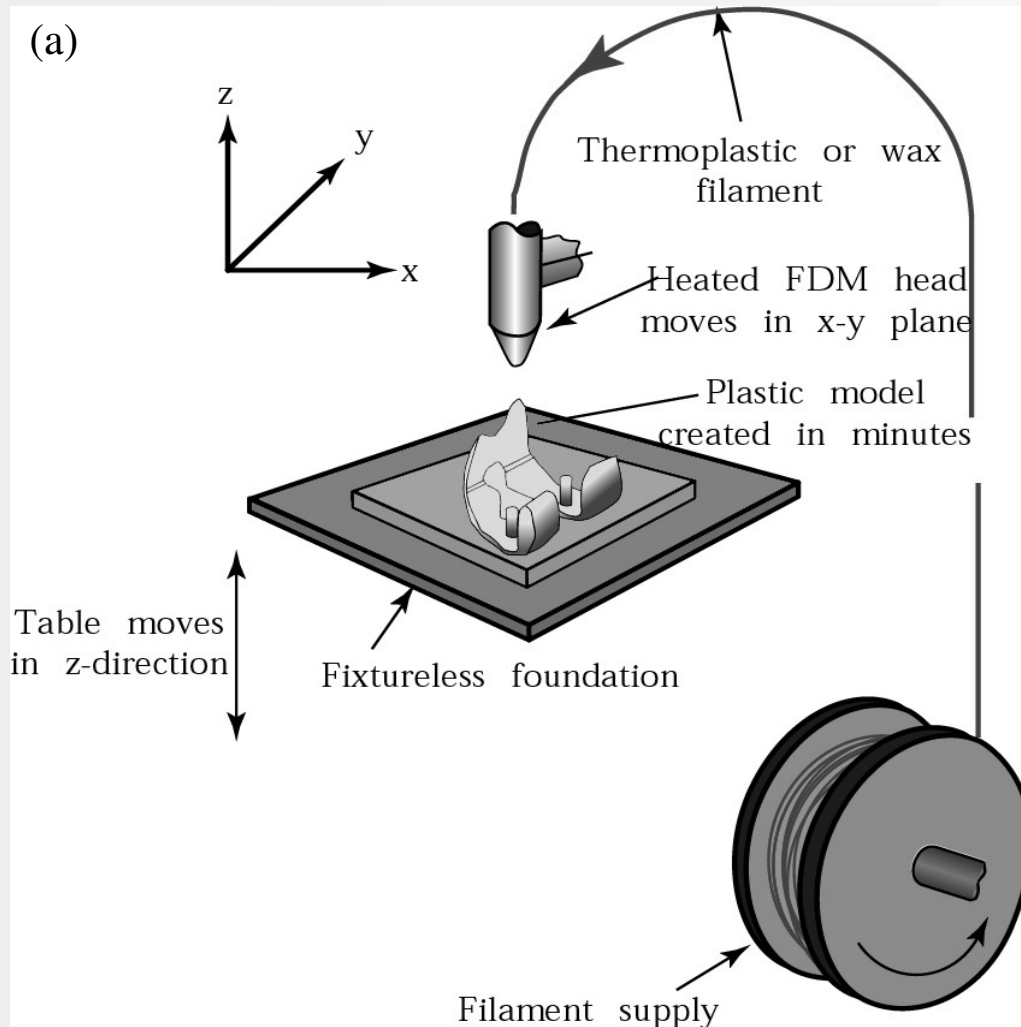

(a) Schematic illustration of the fused-deposition-modeling process.

(b) The FDM 5000, a fused-deposition-modeling-machine. *Source:* Courtesy of Stratysis, Inc.

FDM Machines

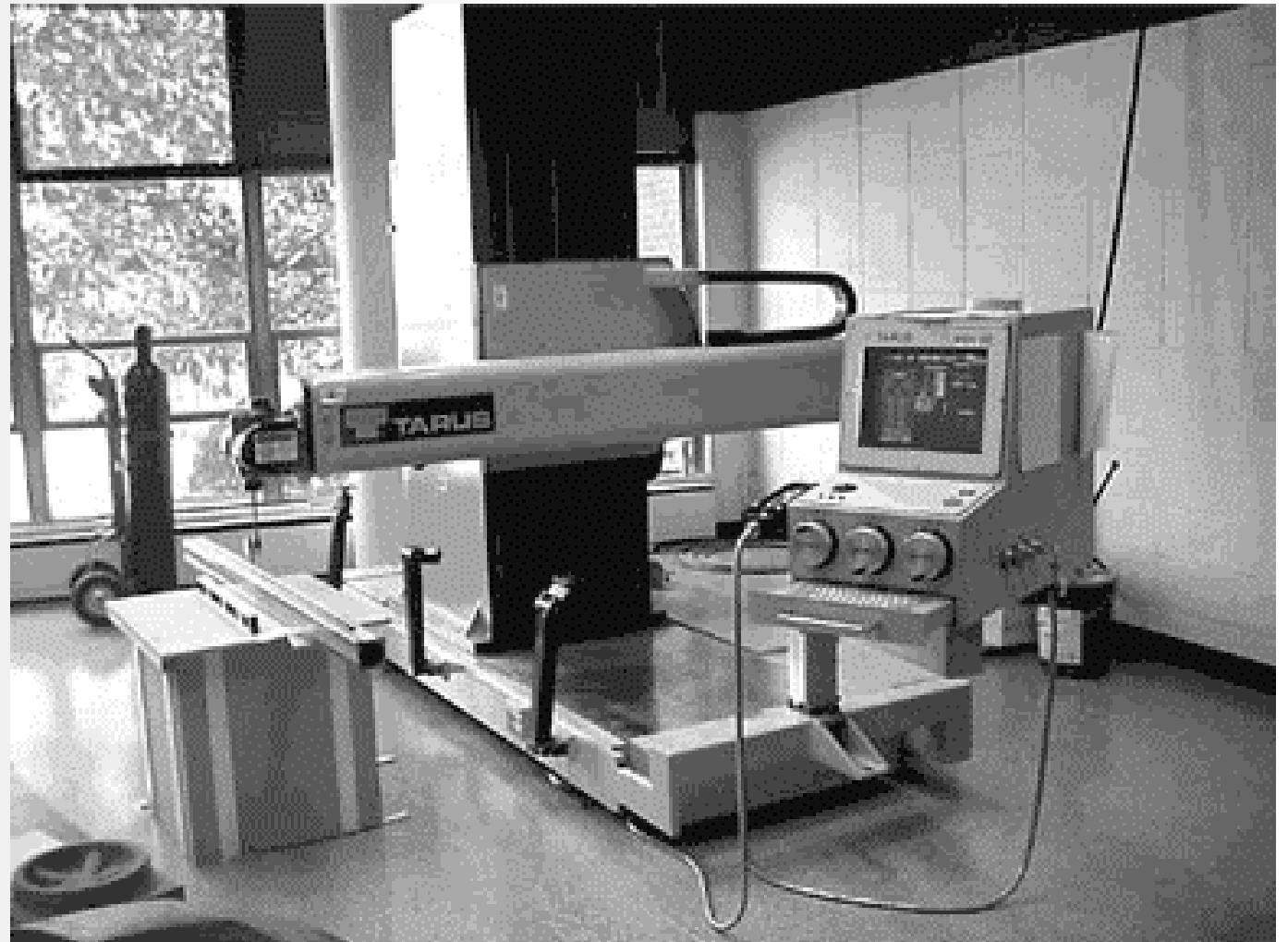

FDM Applications

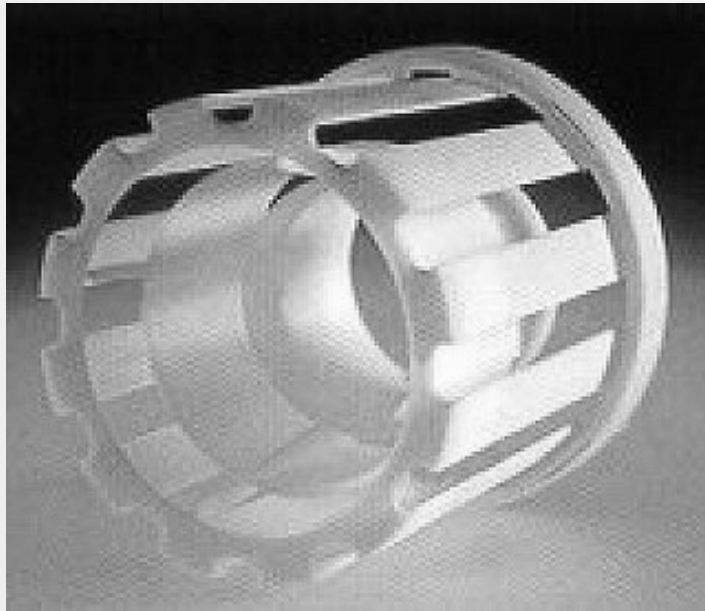
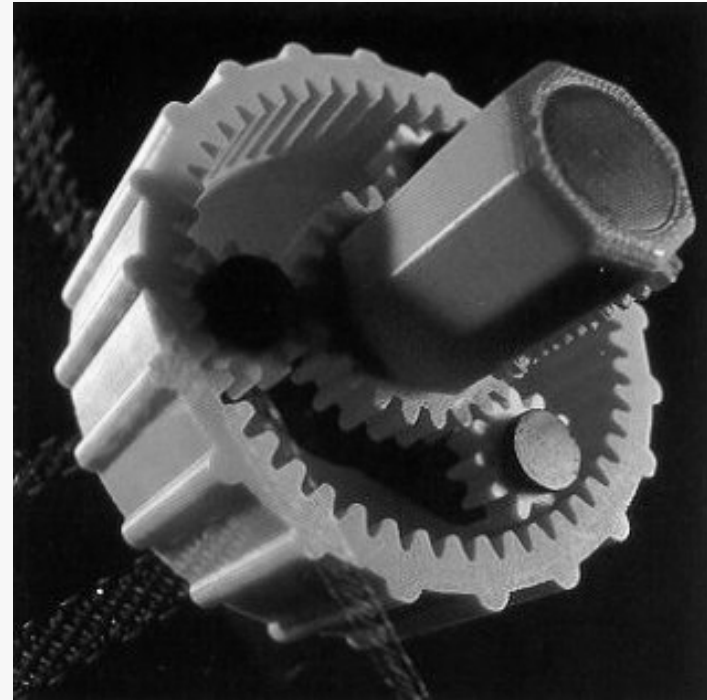

Solid-Base Curing SBC

- Cubital, Troy, MI (Failed 2000)
- patent 1991
- photopolymerization using UV light passing through a mask
- accuracy 0.510 mm
- Photopolymers

Solid-Base Curing

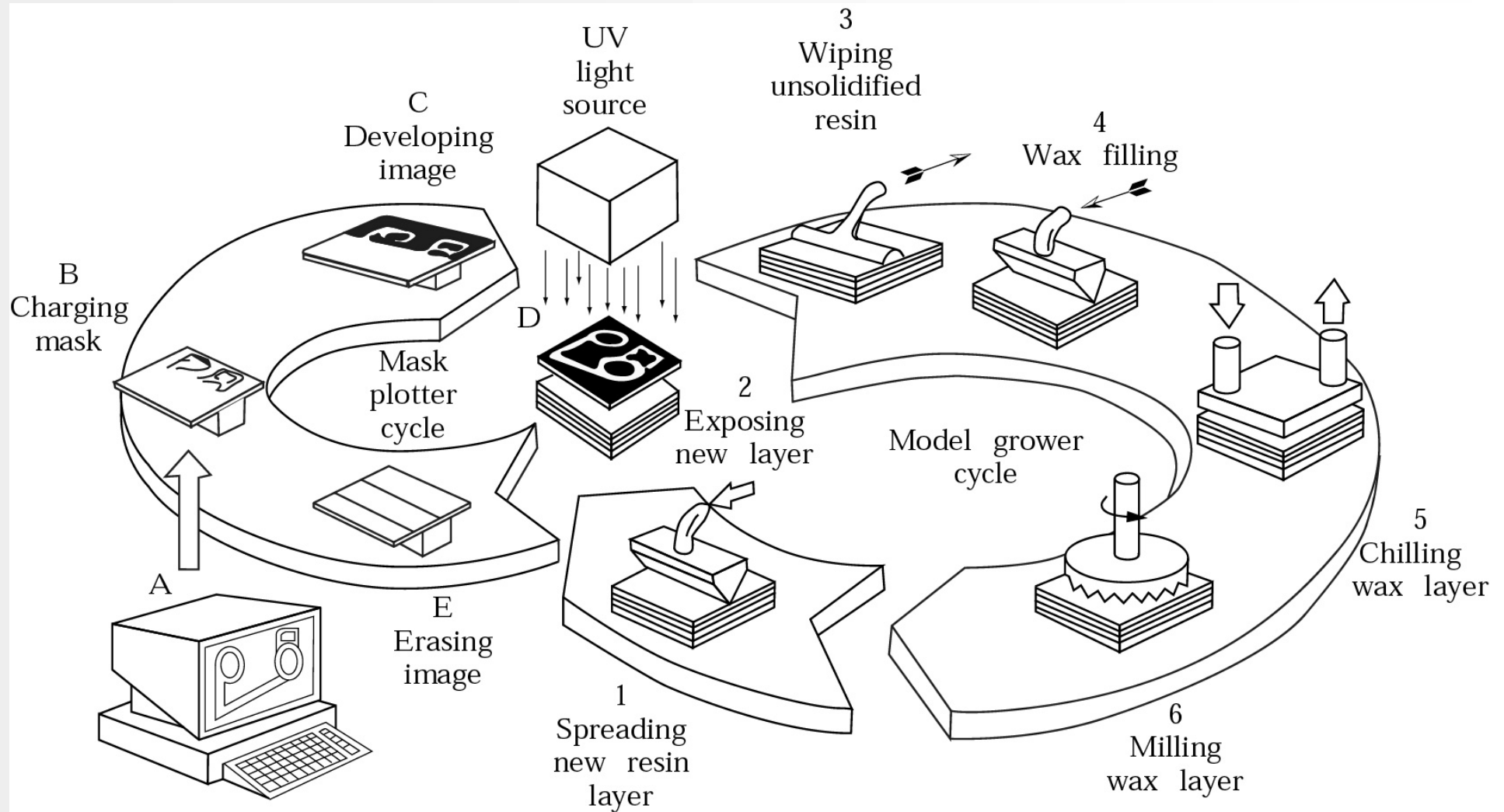

Schematic illustration of the solid-base-curing process. *Source:* After M. Burns, *Automated Fabrication*, Prentice Hall, 1993.

Solid-Base Curing

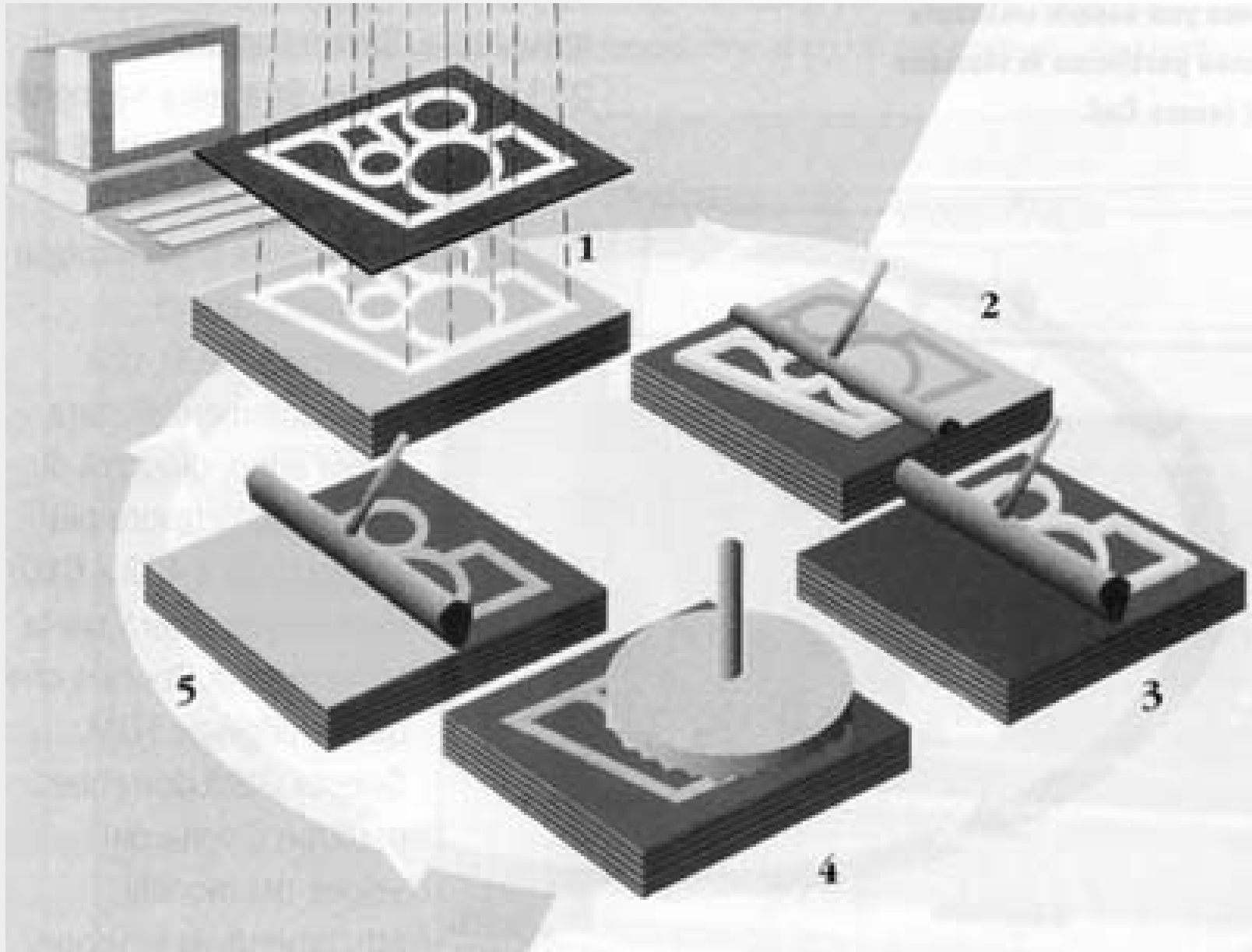

3D Plotting

- Solidscape Inc., Merrimack, NH
- Inkjet technology
- Dual heads deposit part material (thermoplastic) and support material (wax)
- Accuracy 0.025 mm (layers 0.013 mm)
- Thermoplastic (build)
Wax, fatty esters (support)

3D Plotting

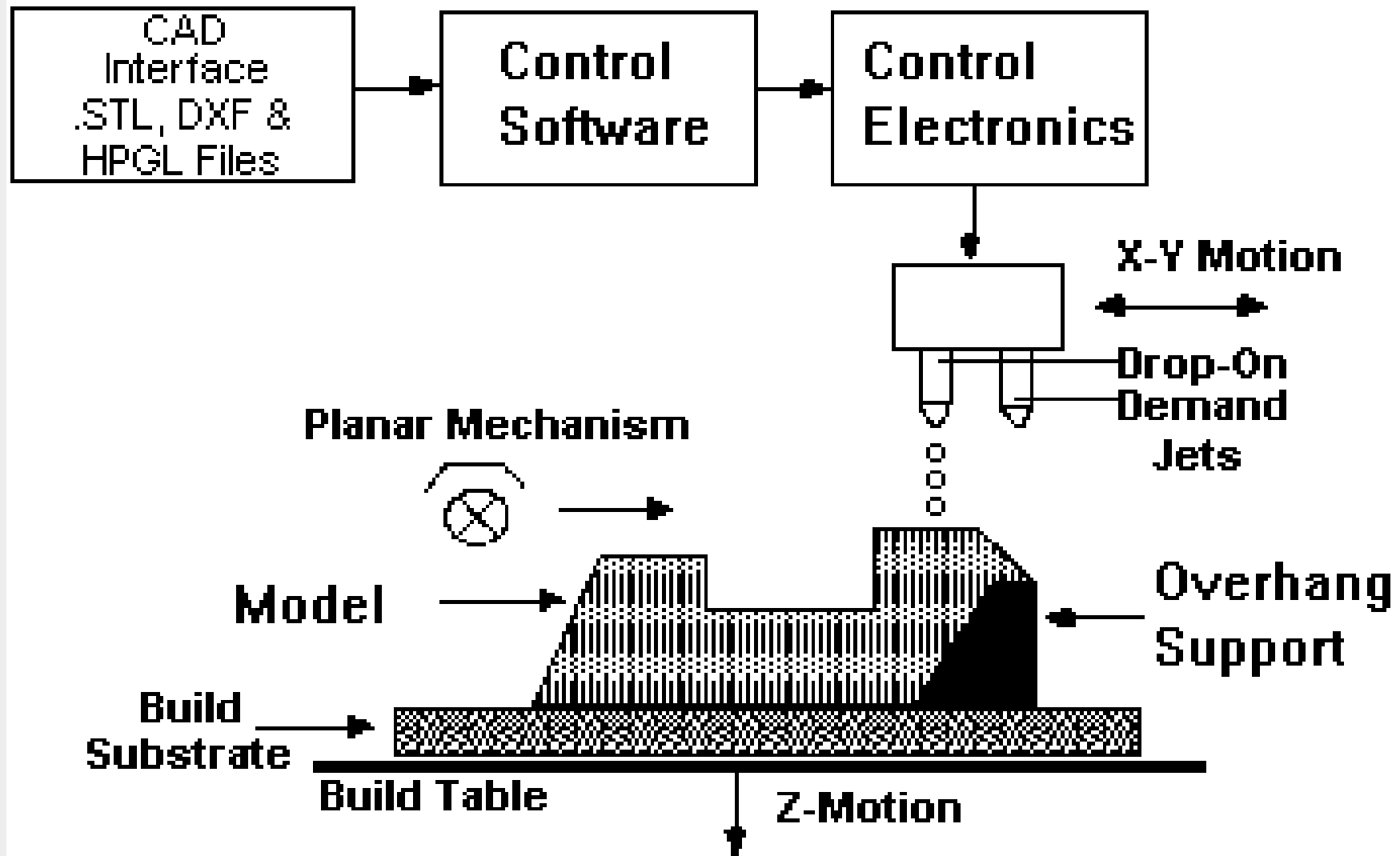

3D Plotting

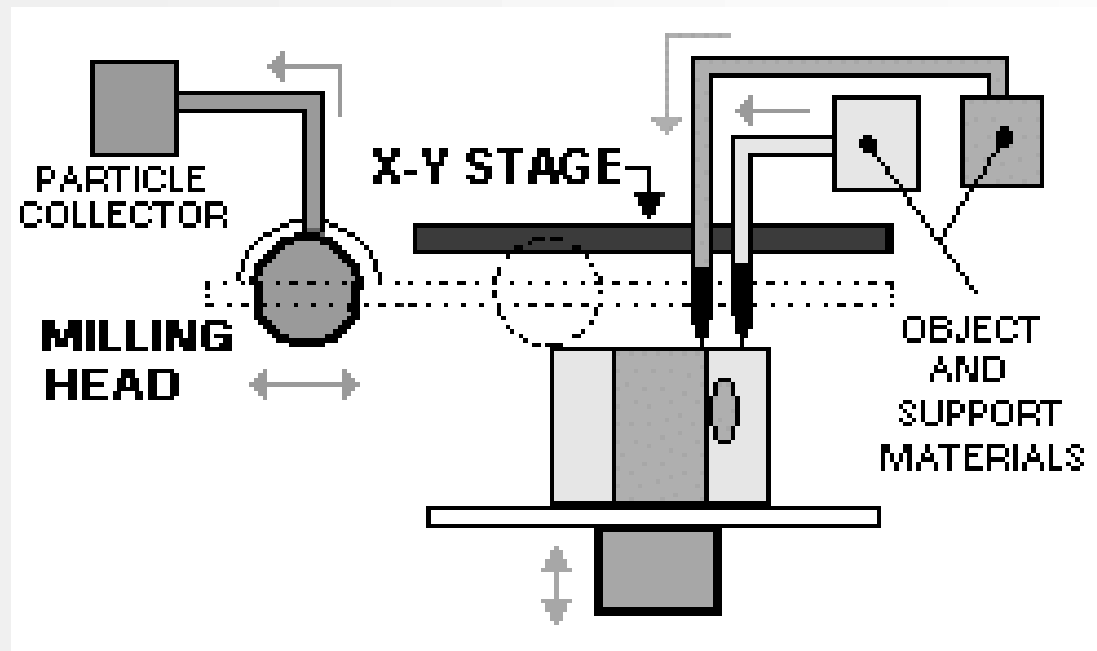

3D Plotting Applications

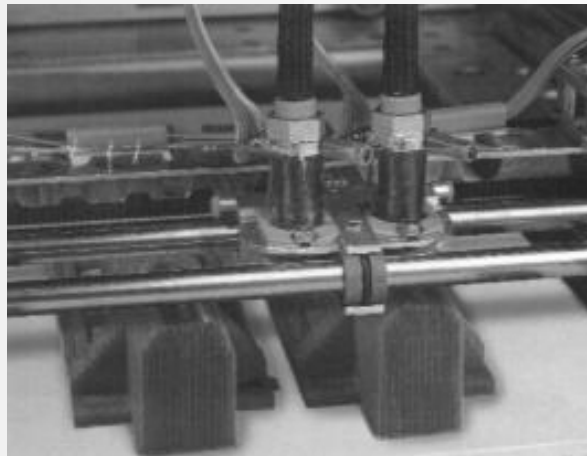

Multi-jet Modelling

MJM

- Accelerated Tech., 3D Systems, Solidimension Ltd
- Inkjet technology
- Multiple heads deposit support material and part material cured immediately by UV light
- Accuracy 0.020 mm
- Photopolymers

Multi-jet Modelling MJM

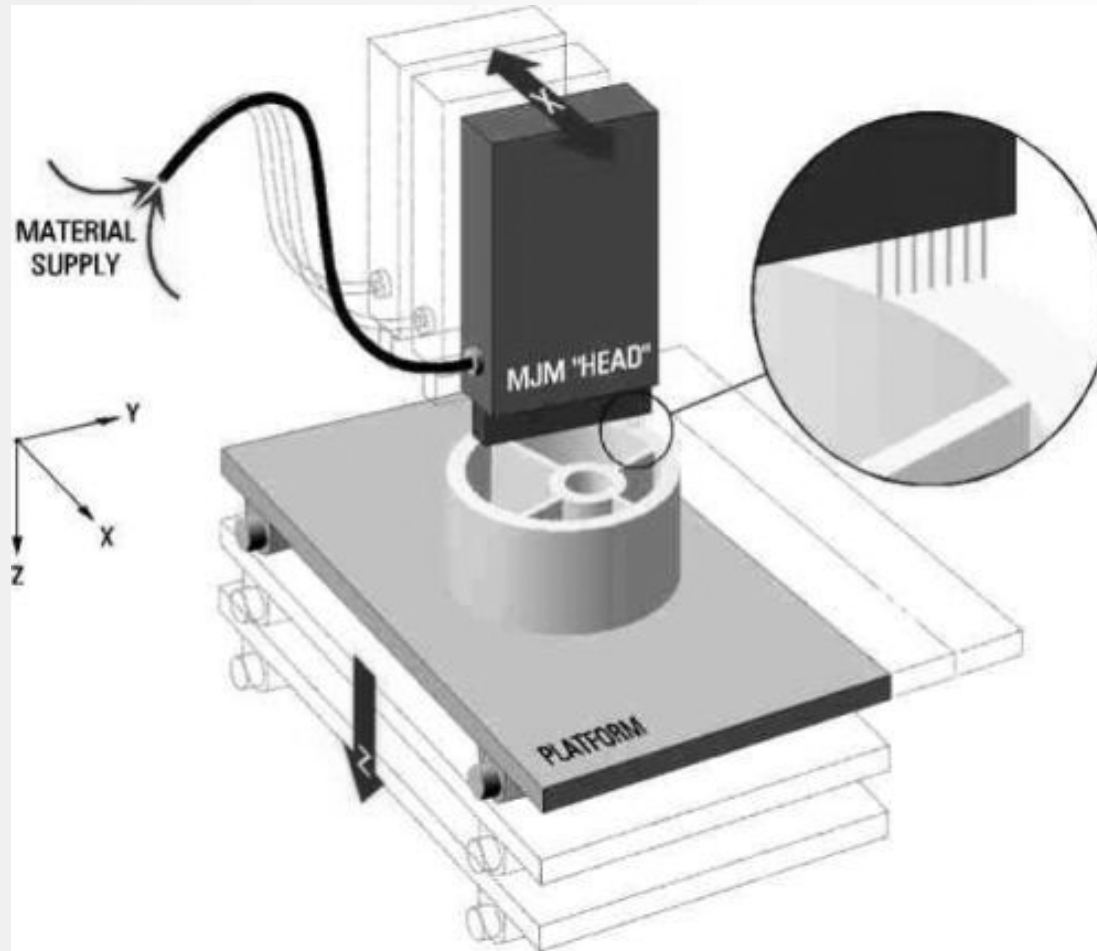

MJM Applications

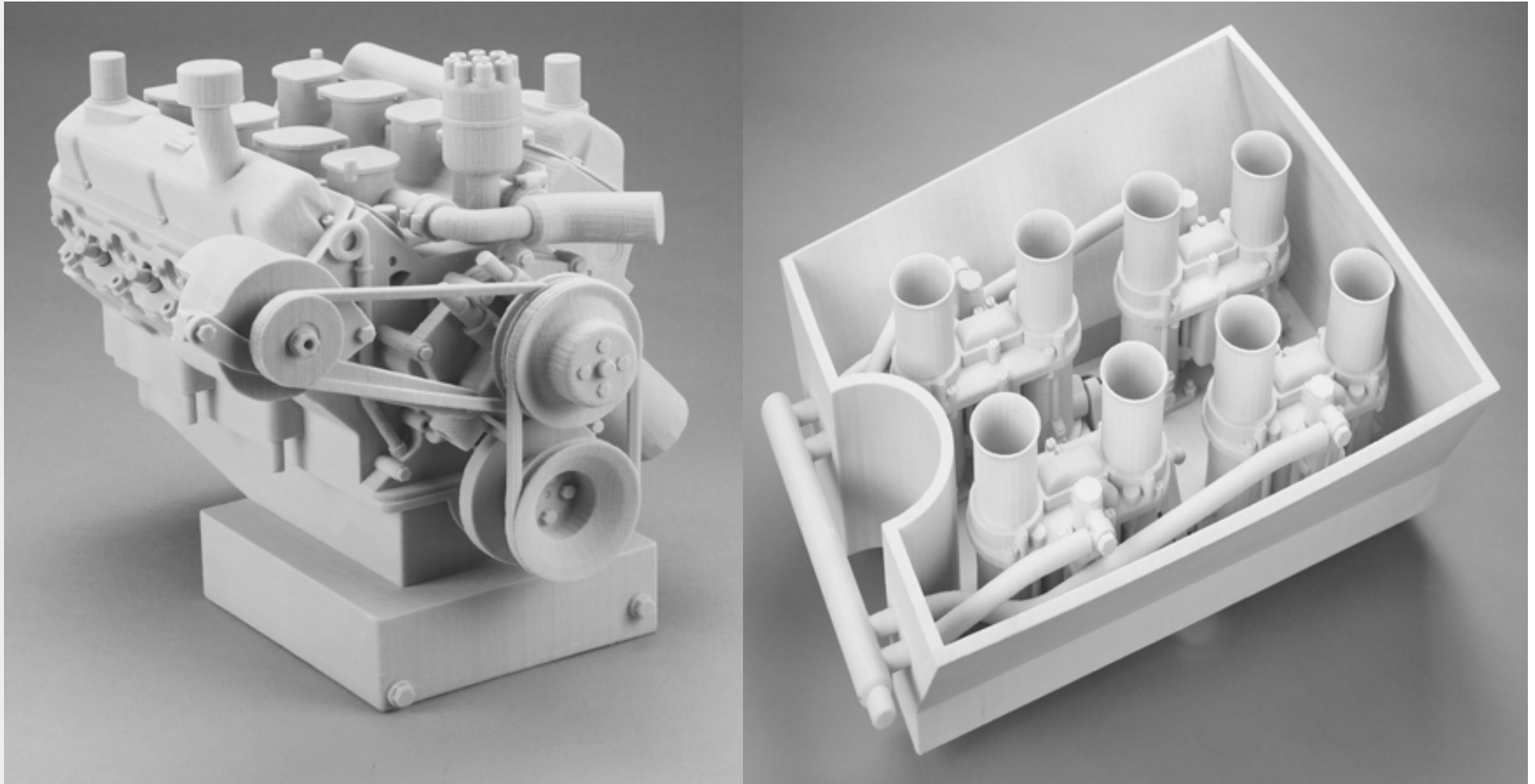

3D Printing 3DP

- Z Corporation, Burlington, MA
- Printing head deposits binder solution on build powder
- Accuracy 0.076 mm
- Waxes, acrylates, epoxies

3D Printing

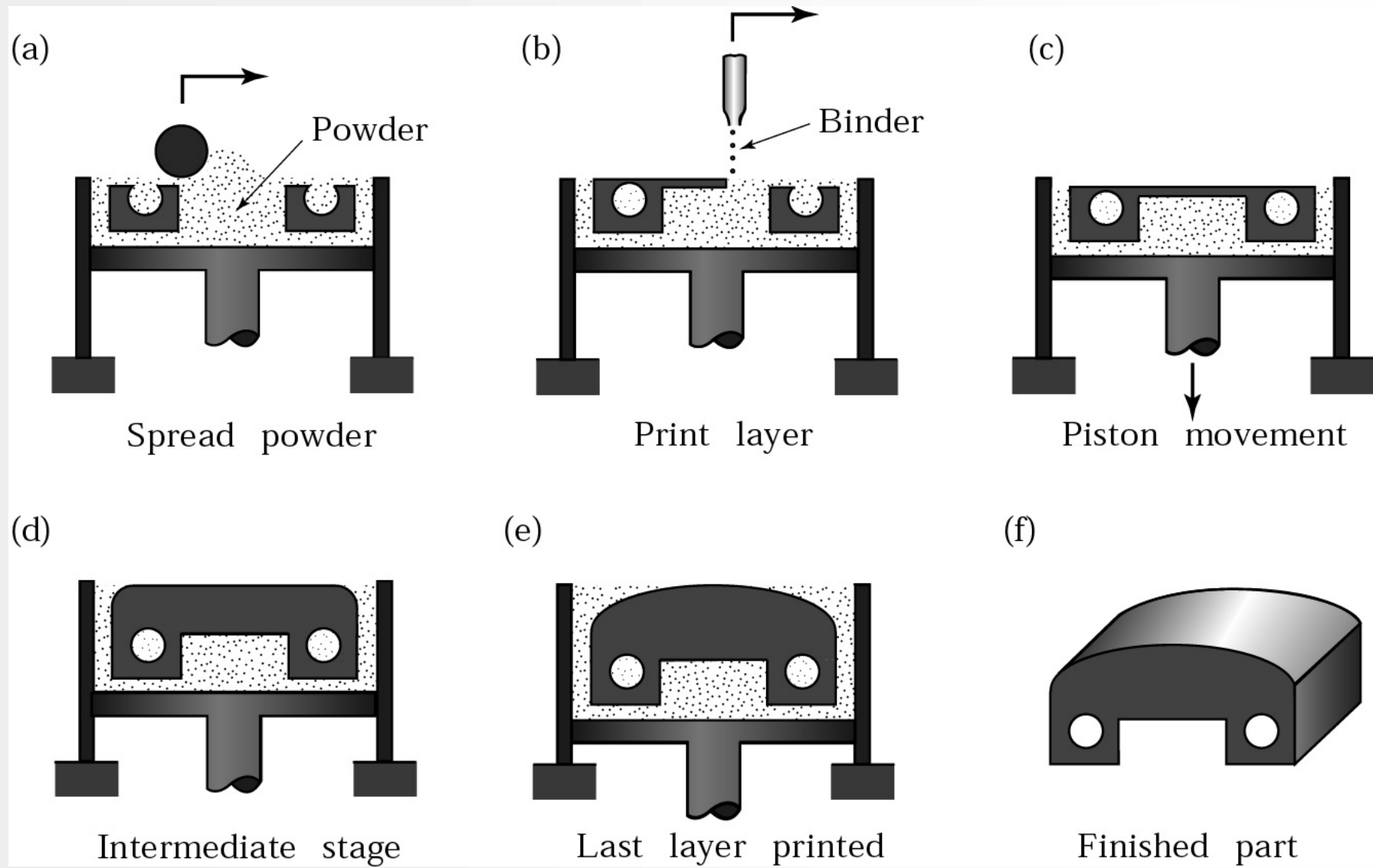

Schematic illustration of the three-dimensional-printing process. *Source*: After E. Sachs and M. Cima.

3D Printing

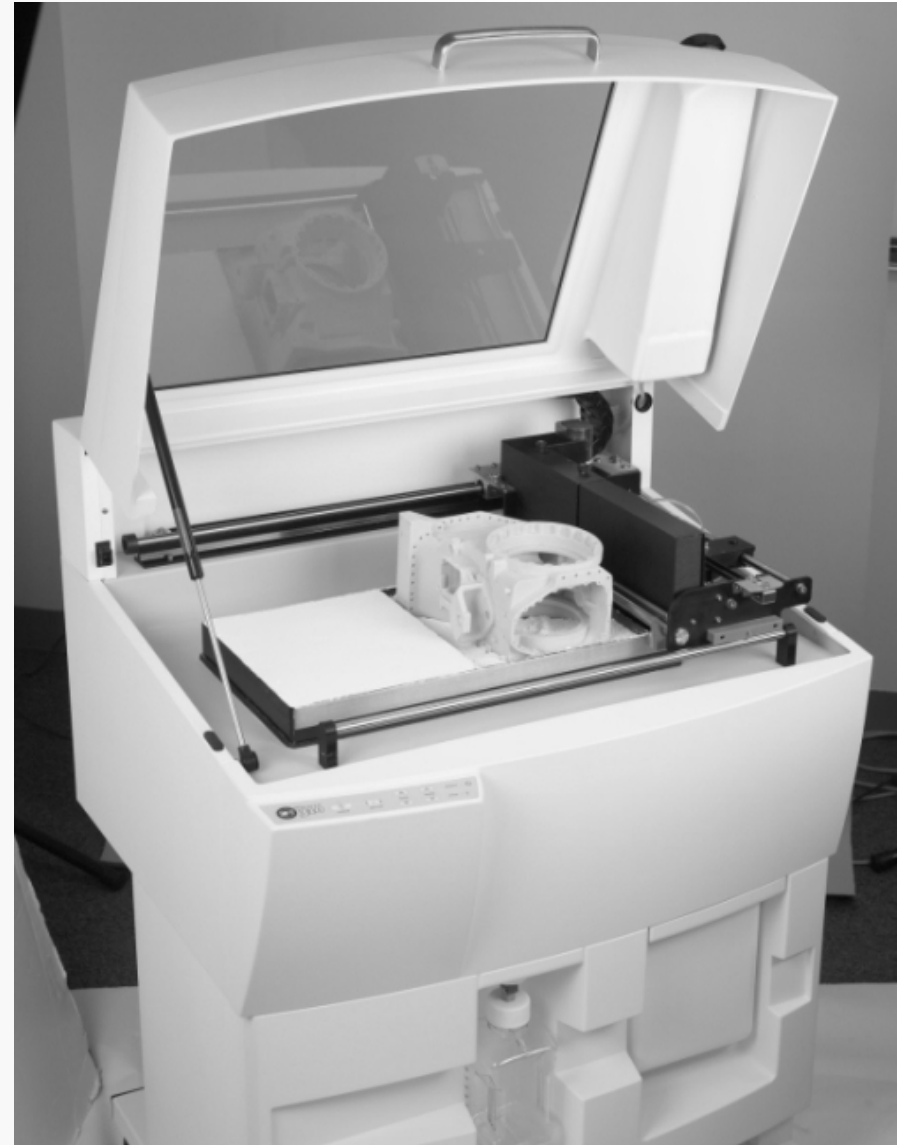
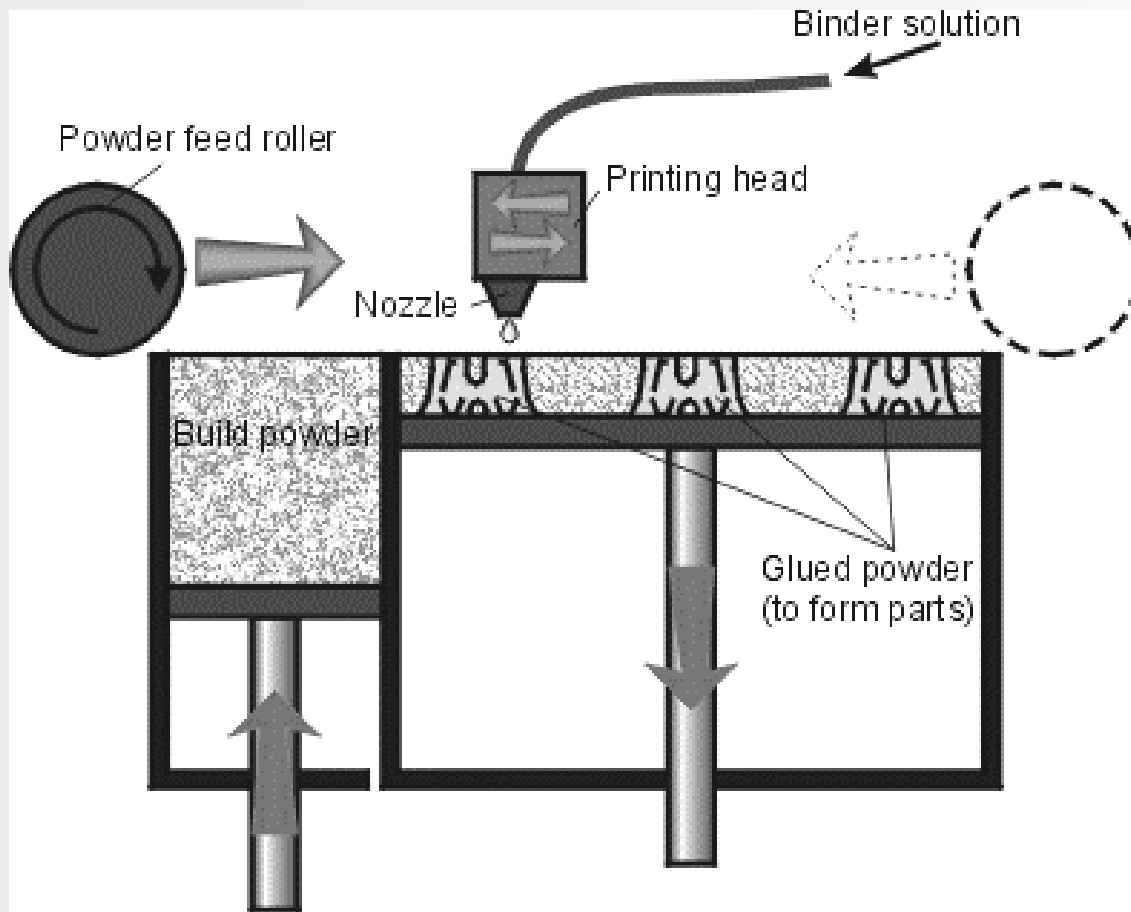

3D Printing Applications

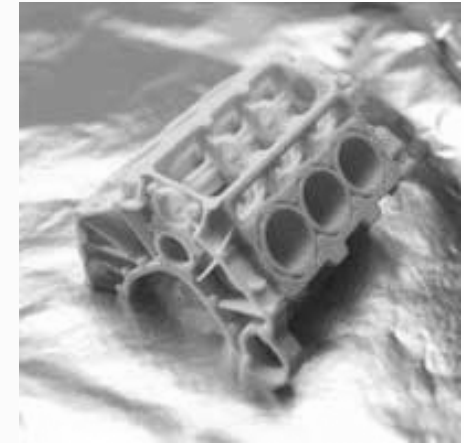

Investment Casting

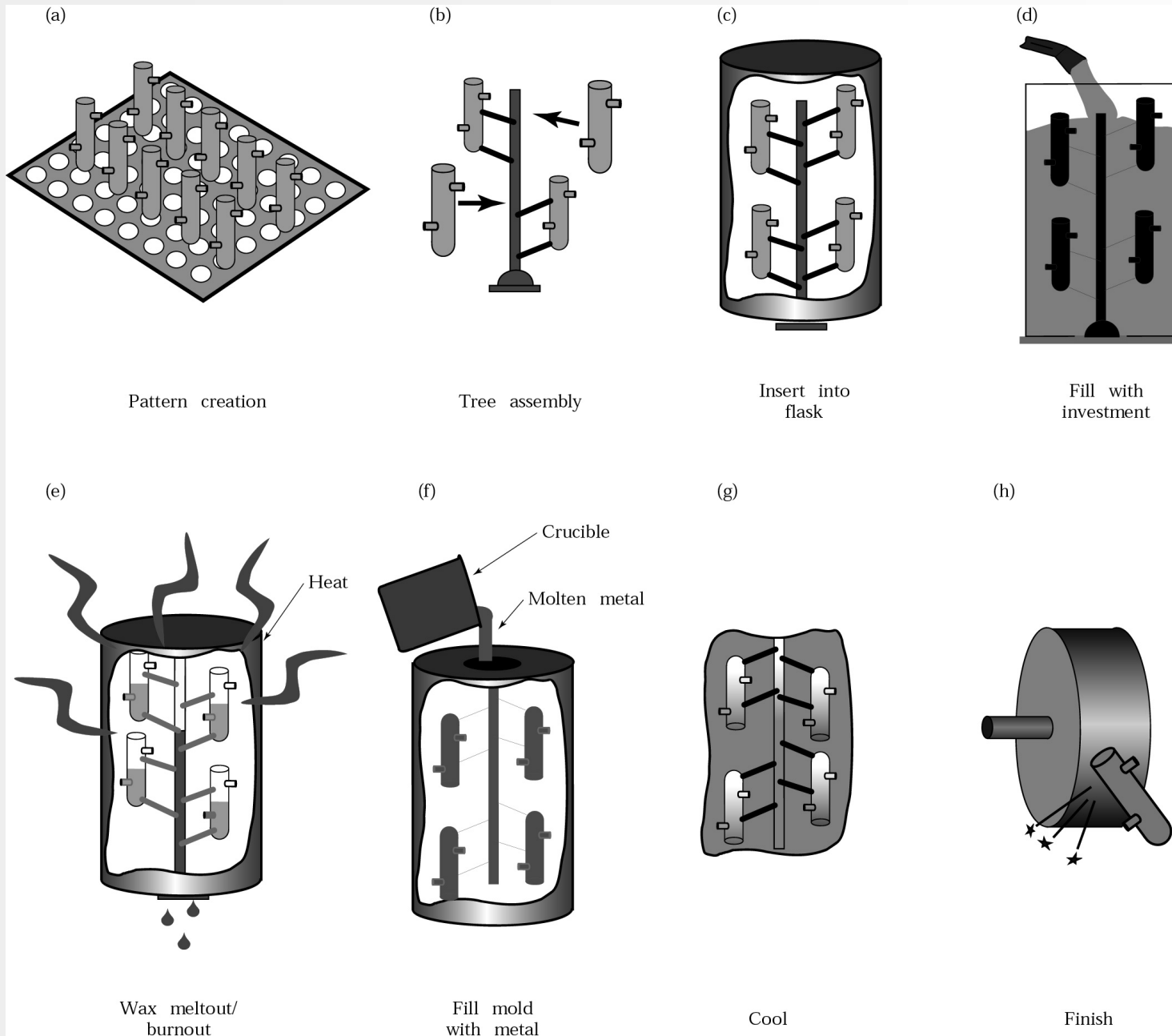

Manufacturing steps for investment casting that uses rapid-prototyped wax parts as blanks. This approach uses a flask for the investment, but a shell method can also be used. *Source:* 3D Systems, Inc.

Manufacturing

Example: Investment Casting

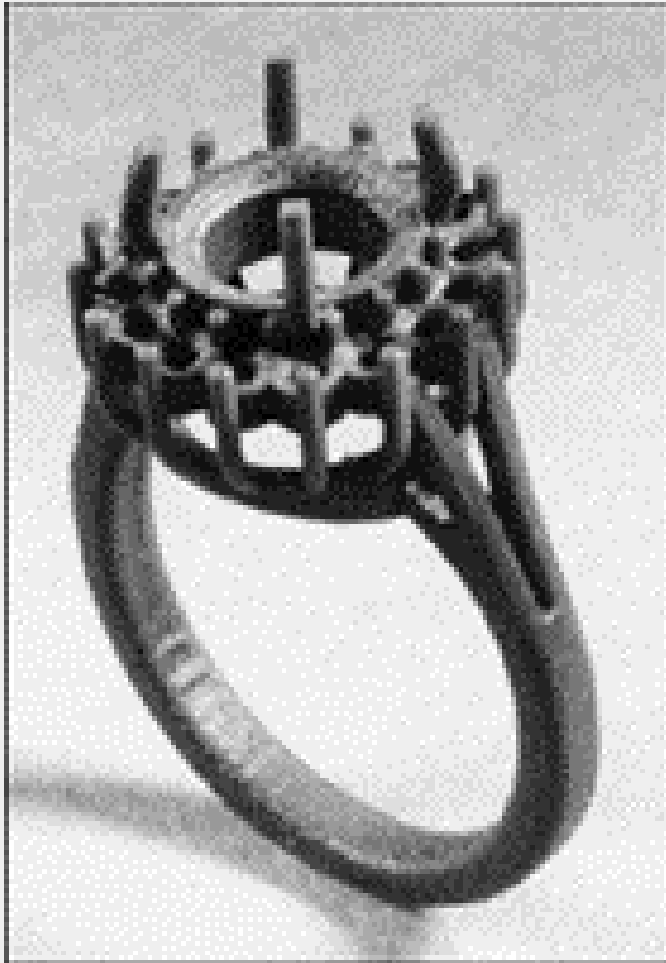

- **Wax pattern build from Stratasy's multi-jet droplet technique**
- **Pattern used in investment casting to fabricate metal ring**
- **Allows for design modifications and quick turnaround of metal band**

Sand Casting Using Rapid-Prototyped Patterns

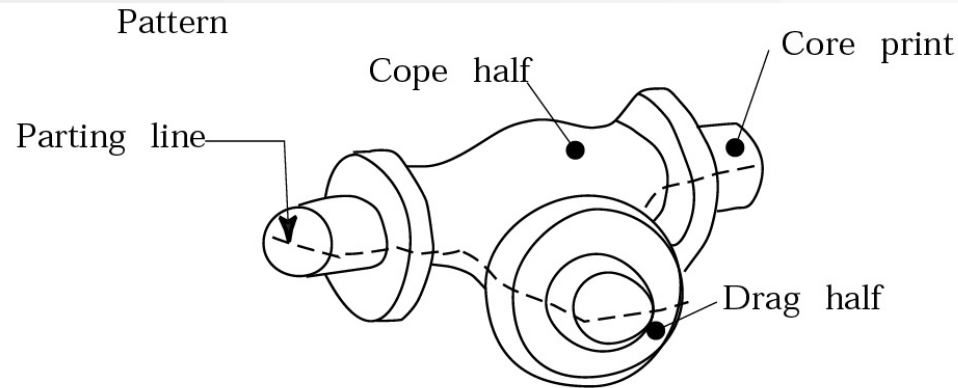

1. Produce pattern using rapid prototyping process.

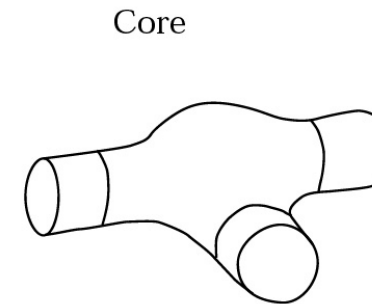

2. Produce sand core from mold produced through rapid prototyping.

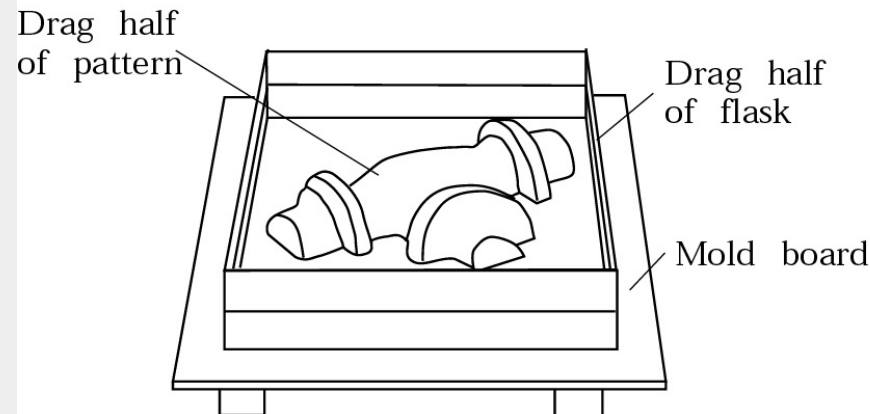

3. Place drag half of pattern on mold board in drag half of flask

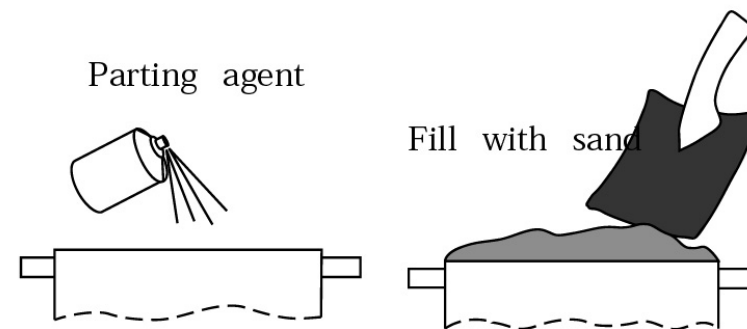

4. Preparing drag half of mold.

Manufacturing steps in sand casting that uses rapid-prototyped patterns.
Source: 3D Systems, Inc.

Sand Casting (continued)

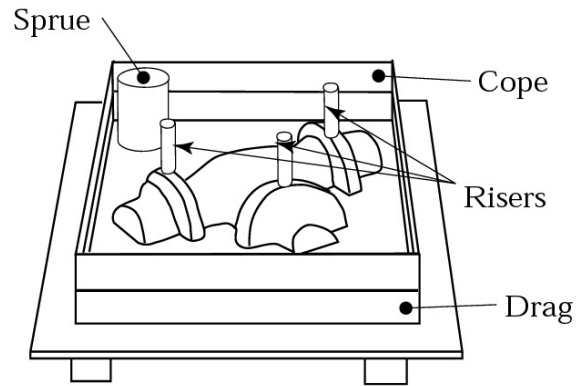

5. Roll drag over, place cope half of pattern and flask.
Note: sprue and risers are standard inserts

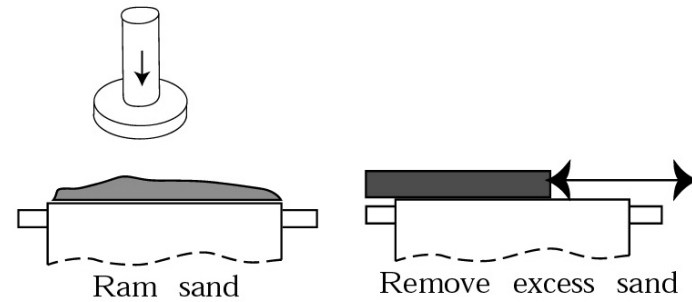

6. Preparing cope half of mold;
this step must be repeated for
each half of the mold

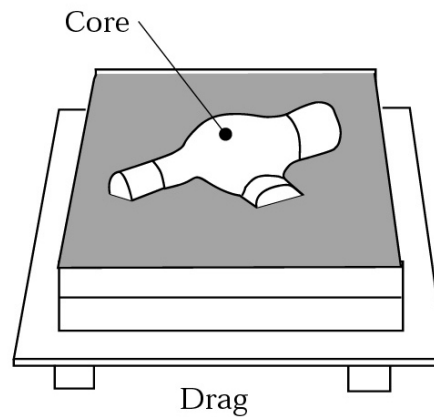
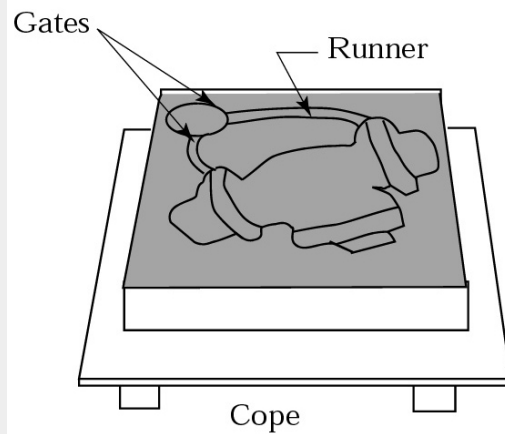

7. Separate flask – remove all patterns.
Place core in place, close flask.

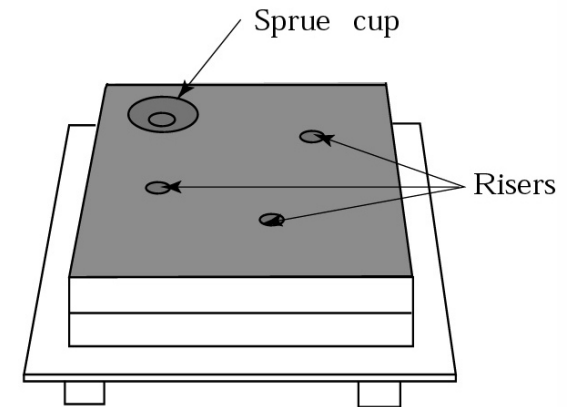

8. Flask closed and clamped,
ready for pouring of molten
metal.

Rapid Tooling

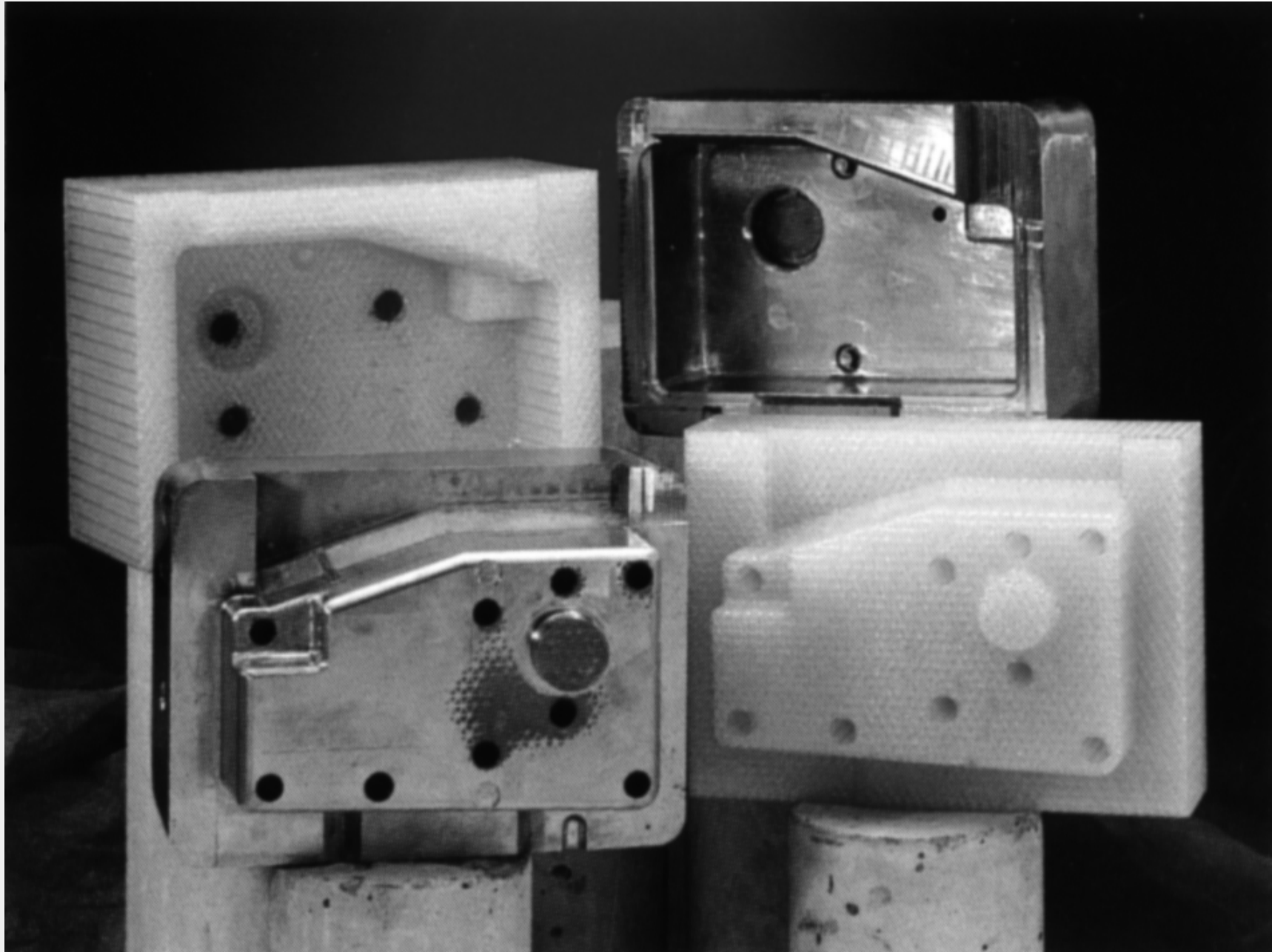

Rapid tooling for a rear-wiper-motor cover

Benefits to RP Technologies

Visualization, verification, iteration, and design optimization

Communication tool for simultaneous engineering

Form-fit-function tests

Marketing studies of consumer preferences

Metal prototypes fabricated from polymer parts

Tooling fabricated from polymer parts



SNS College of Technology

[An Autonomous Institution]

Approved by AICTE, New Delhi, Affiliated to Anna University, Chennai

Accredited by NAAC-UGC with 'A++' Grade (Cycle III) &

Accredited by NBA (B.E CSE, EEE, ECE, IT & Mech)

COIMBATORE-641 035, TAMIL NADU



Department of Aerospace Engineering

19AST202 AIRCRAFT PRODUCTION TECHNOLOGY

ADDITIVE MANUFACTURING IN AEROSPACE

Conclusions

- Rapid prototyping is a new tool, which used appropriately ...
 - allows the manufacturing enterprise to run smoother
 - increases throughput and product quality
- New uses and applications are discovered everyday
- Future areas include new materials directly deposited (metals, ceramics)