

# ELECTRO PHYSIOLOGY

Cell and Its Structure - Electrical, Mechanical and Chemical Activities - Action and Resting Potential- Organization of Nervous System - CNS - PNS - Neurons - Axons- Synapse - Propagation of Electrical Impulses along the Nerve-Sodium Pump - Cardio Pulmonary System- Physiology of Heart, Lung, Kidney.

## INTRODUCTION

Application of **knowledge and technologies** to solve problems related to living biological systems. **Diagnosis, treatment and prevention** of disease in human. The term “bio” to denote something related to life. When basics of physics and chemistry get applied to the living things, and we name them as **Biophysics and Biochemistry**. So when the discipline of engineering and medicine interacts, it is called **Biomedical Engineering**. **Measurement of biological signals** like ECG, EMG, or any electrical signals generated in the human body. Biomedical Instrumentation helps physicians to diagnose the problem and provide treatment.

To **measure biological signals and to design a medical instrument**, concepts of electronics and measurement techniques are needed. The basic living unit of the body is the **cell**. To understand the function of organs and other structures of the body it is necessary to study the basic organization of the cell. Each organ of our body consists of an aggregate cells. The entire body contains **100 trillion cells**. **25 trillion RBC** – which transports oxygen from the lungs to the tissues. The **oxygen combines with carbohydrate, fat or protein to release the energy required for cell function**.

## CELLS AND THEIR STRUCTURE

The basic living unit of the body is cell. Each organ of our body is an aggregate of many different cells held together by intercellular supporting structures. Each type of cell is meant for performing one particular function. The entire body contains about 100 trillion cells. Among these, there are 25 trillion red blood cells which transport oxygen from the lungs to the tissues. Cells have the ability to reproduce new cells whenever the cells of a particular types are destroyed. In all cells, oxygen combines with carbohydrate, fat or protein to release the energy required for cell function Each cell consists of a centrally located nucleus (cell core) surrounded by the cytoplasm (cell body).

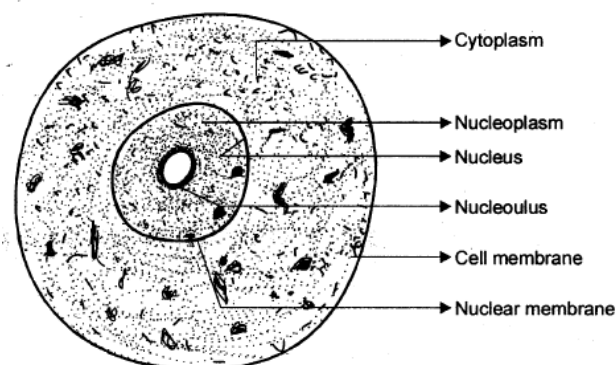

**Figure 1.1 Structure of the Cell**

The nucleus is separated by from the cytoplasm by a nuclear membrane and the cytoplasm is separated from the surrounding fluids by a cell membrane. The nucleus is

separated by from the cytoplasm by a nuclear membrane and the cytoplasm is separated from the surrounding fluids by a cell membrane. The different substances that make up the cell are collectively called protoplasm which is mainly composed of water, electrolytes, proteins lipids and carbohydrates.

**Water:** (70 - 85%) serves as a solvent for various chemicals to produce chemical reactions. **Electrolytes:** provide inorganic chemicals for cellular reactions. eg: potassium, Mg, PO<sub>4</sub>, Na, Ca, Sulphate, chloride etc. **Proteins:** Constitute 10 to 20% of the cells mass provide energy for cellular functions. **Lipids:** Used to form membranous barriers that separate the different intracellular compartments. eg: phospholipids, cholesterol. **Carbohydrates:** plays major role in nutrition of the cell.

They are stored in the cells in the form of glycogen which are used to supply the cells energy needs rapidly and are present in the extracellular fluid in the form of glucose. The cell also contains highly organised physical structures called organelles consisting of cell's chemical constituents. The cytoplasm is filled with cytosol in which the minute and large particles and organelles are dispersed. Ribosomes are minute granular particles in the cytosol and are composed of a mixture of ribonucleic acid (RNA) & proteins and they function in the synthesis of protein in the cells. Lysosomes are vesicular organelles allows the cell to digest and thereby remove unwanted substances and damaged or foreign structures such as bacteria. Mitochondria organelles are called "power houses" of the cell. The cell extract significant amount of the energy from the nutrients and oxygen by means of mitochondria.

Mitochondria contain DNA found in nucleus. DNA is the basic substance of the nucleus that contains replication of the cell. Nucleus contains large quantities of DNA which are called genes. The nucleus is surrounded by nuclear inner and outer membranes. Inside the nucleus, there is a structure called nucleolus, which contains a large amount of RNA. The size of the cells is in the range 5-10 µm depending on the amount of functioning DNA in the nucleus.

## RESTING AND ACTION POTENTIALS

### Resting Potentials

Certain types of cells within the body, such as nerve and muscle cells, are encased in a **semipermeable membrane** that permits some substance to pass through the membrane while others are kept out. Surrounding the cells of the body are the **body fluids**. These fluids are conductive solutions containing **charged atoms known as ions**. The principle ions are **sodium (Na<sup>+</sup>), potassium (K<sup>+</sup>) and chloride (C<sup>-</sup>)**. The membrane of excitable cells readily **permits entry of potassium and chloride ions** but **blocks the entry of sodium ions**. Since the various ions **seek a balance between the inside of the cell** and the outside according to concentration and electric charge, the inability of the sodium to penetrate the membrane results in **2 conditions**.

(1) The concentration of sodium ions inside the cell becomes much lower than in the intercellular fluid outside. Since the sodium ions are positive this would tend to make the **outside of the cell more positive than the inside**. (2) In an attempt to balance the electric charge **additional potassium ions**, which are **also positive enter the cell**, causing a higher concentration of potassium on inside than on the outside.

**Equilibrium is reached with a potential difference** across the membrane, negative on the inside and positive on the outside. This membrane potential is called the **resting**

**potential of the cell.** Since the measurement of the **membrane potential** is generally made from inside the cell w.r.t the body fluids, the resting potential of a cell is given as negative. Membrane potentials in various cells ranging from **-60 to -100 mV**. A cell in the resting state is said to be **polarized**.

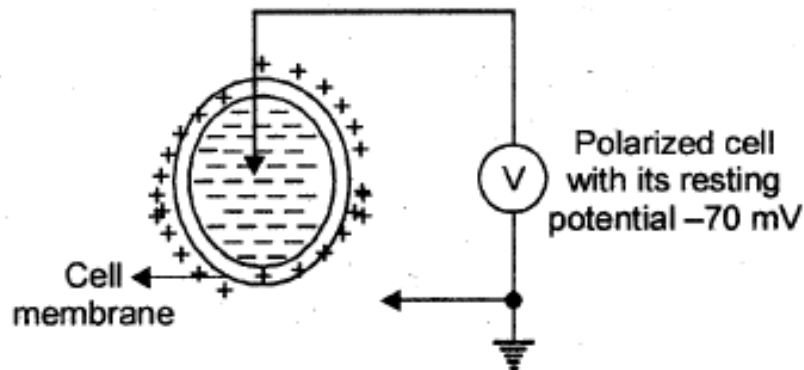

**Figure 1.2 Polarized cell with its resting potential**

The **sodium ions literally rush into the cell** to try to reach a balance with the ions outside. At the **same time potassium ions**, which were in higher concentration inside the cell **during the resting state** try to leave the cell but are unable to move as rapidly as the sodium ions. Therefore the cell has a **slightly positive potential on the inside due to the imbalance of potassium ions**. This **positive potential of the cell membrane during excitation is called action potential** & is about **20 mv**. As long as the action potential exists, the cell is said to be **depolarised**. The process of **changing from the resting state to the action potential** is called **depolarization**. When the **passage of sodium ions is stopped**, the ionic currents that lowered the barrier to sodium ions are no longer present and the membrane reverts **back to the original (polarised) condition**.

By the **action of sodium pump**, the **sodium ions are quickly transported to the outside of the cell** & the cell is in its resting potential. This process is called **repolarization**. The **rate of pumping is directly proportional to the sodium concentration in the cell**. Generally in **nerve & muscle cells repolarisation occurs so rapidly** following depolarisation that the action potential appears on a **spike of as little as 1 millisecond total duration**. But for heart muscle, the action potential is withstanding from 150 to 300 msec & so it repolarizes more slowly. The process of changing from **the resting state to the action potential** is called **depolarization**.

When the **passage of sodium ions is stopped**, the ionic currents that lowered the barrier to sodium ions are no longer present and the **membrane reverts back to the original (polarised) condition**. By the **action of sodium pump**, the sodium ions are **quickly transported to the outside of the cell** & the cell is in its resting potential. This process is called repolarization. **The rate of pumping is directly proportional to the sodium concentration in the cell**. Generally in **nerve & muscle cells repolarisation occurs so rapidly** following depolarisation that the action potential appears on a **spike of as little as 1 millisecond total duration**. But for heart muscle, the action potential is withstanding from 150 to 300 msec & so it repolarizes more slowly.

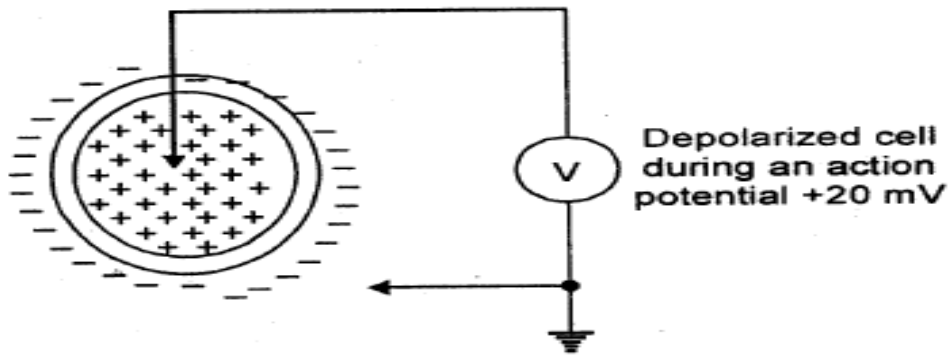

Figure 1.3 Depolarized of a cell  $\text{Na}^+$  ions with into the cell while  $\text{k}^+$  ions attempt to leave

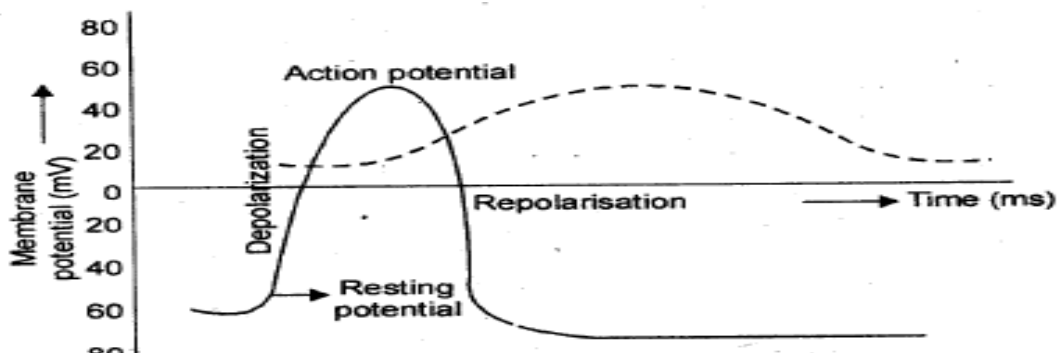

Figure 1.4 Waveform of the action potential

## SODIUM PUMP

They **produce charge** imbalance across the cell membrane & can also **contribute directly to the membrane potential**. All pumps use energy to function. Regardless of method of excitation of cells or the intensity of the stimulus, (which is assumed to be greater than the threshold of stimulus) the action potential is always the same for any given cell. This known as all-or-nothing law.

### Net height

The net height of the action potential is defined as the difference between the potential of the depolarized membrane at the peak of the action potential & the resting potential.

### Absolute refractory period

Following the **generation of an action potential**, there is a brief period of time during which the cell cannot respond to any new stimulus. This period called the absolute refractory period, lasts about 1msec in nerve cells.

### Relative refractory period

Following the absolute refractory period, there occurs a relative refractory period, during which another action potential can be triggered, but a much stronger stimulation is required. This period lasts several milliseconds.

## ORGANISATION OF NERVOUS SYSTEM

The basic unit of the nervous system is the **neuron**. A neuron is a single cell with a cell body called **soma**. One or more “input” fibers called **dendrites**. A long transmitting fiber called the ‘**axon**’. The axon branches near its ending into two or more terminals. The portion of the axon immediately adjacent to the cell body is called ‘**axon hillock**’. This is the point at which action potentials are generated. Certain types of neurons have axons or dendrites coated with a fatty insulating substance called ‘**myelin**’. The coating is called a myelin sheath and the fibre is said to be **myelinated**. The myelin sheath is interrupted at **regular intervals** by the ‘**nodes of Ranvier**’, which help speed the transmission of information along the nerves.

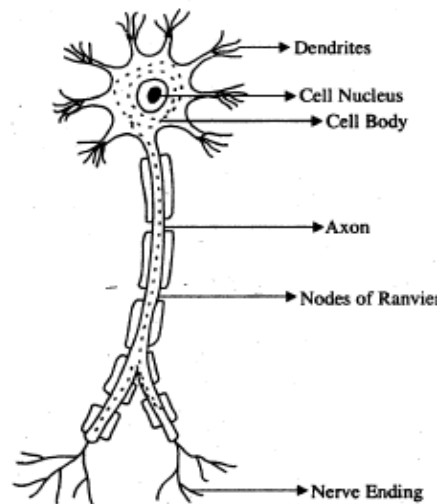

**Figure 1.5 Nervous System**

The myelin sheath is surrounded by another insulating layer called the ‘**neurilemma**’. This layer, thinner than the myelin sheath and continuous over the nodes of ranvier, is made up of thin cells, called **Schwann cells**. Some neurons have long dendrites, whereas others have short ones. **Axons of various length also found**. It is difficult to tell a dendrite from an axon. The main **difference is in the function of the fiber and the direction** is in the function of the fiber and the direction in which it carries information w.r.t the cell body.

Both **axons and dendrites** are called **nerve fibers**. A **bundle of individual nerve fibers** is called a **nerve**. **Nerves the carry sensory information from the various parts of the body to the brain** are called **afferent nerves**. **Nerves that carry signals from the brain to operate various muscles** are called **efferent nerves**. The interconnections bet neurons are called **synapses**. All synapses occur at or near cell bodies.

## CENTRAL NERVOUS SYSTEM

The brain is an enlarged collection of **cell bodies and fibers** located inside the skull, where it is well **protected** from light as well as from physical, chemical or temperature shocks. At its **lower end, the brain connects with the spinal cord**, which also consists of many cell bodies and fiber bundles. Together the **brain and spiral cord comprise** one of the main divisions of the nervous system, the central nervous system (CNS). The CNS also contains a number of **large fatty cell bodies called glial cells**. About half the brain is composed of **glial cells that play a vital role in ridding the brain of foreign substance** and seem to have some function in connection with memory.

**Cell bodies and small fibers in fresh brain are gray in color** and are called gray matter, whereas the myelin coating of larger fibers has a white appearance. So that a collection of these fibers is referred as white matter. Collections of neuronal cell bodies within the CNS are called **nuclei**. While similar collections outside the CNS are called ganglia. The CNS is generally considered to be **bilaterally symmetrical**, which means that most structures are anatomically duplicated on both sides. Several of the functions of the **CNS are crossed over**, so that neural structures on the left side of the brain are functionally related to the right side of the body and vice versa. Nerve fibers outside the CNS are called **peripheral nerves**.

## PERIPHERAL NERVOUS SYSTEM (PNS)

Peripheral nerves contain both **afferent and efferent fibers**. Afferent peripheral nerves that bring sensory information into the CNS are called **sensory nerves**. Efferent nerves that control the motor functions of muscles are called **motor nerves**. The **PNS** actually consists of **several subsystems**. The system of **afferent nerves** that carry sensory information from the **sensors on the skin to the brain** is called the somatic sensory nervous systems.

**Visual pathways** carry sensory information from the **eyes to the brain**. The auditory nervous system carries information from the auditory sensors in the **ears to the brain**. Another major division of PNS is the **autonomic nervous system**, which is involved with **emotional responses and controls smooth muscle** in various parts of the body, heart muscle and the secretion of a number of glands.

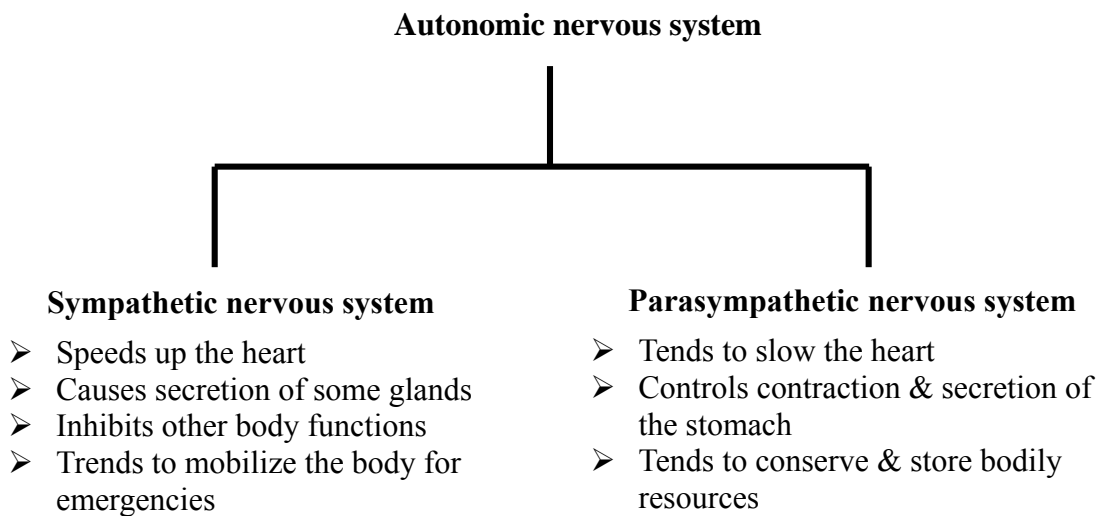

## CENTRAL NERVOUS SYSTEM

Forms the control centre of entire system. The brain stem continues directly into the spinal cord. It consists of **10<sup>10</sup> neurons**. The brain consists of **cerebrum, cerebellum and the brain stem**. The cerebrum consists of two hemispheres and the hemispheres are divided into **1) frontal lobe, 2) parietal lobe, 3) occipital lobe and 4) temporal lobe**. The **frontal lobes** are responsible for intelligence, constructive imagination and abstract thought. The outer layer of the brain is called **cerebral cortex**. The areas in the brain cerebral cortex is responsible for sight, hearing, touch and control of the voluntary muscles of the body.

**Temporal lobe:** The upper side of the temporal lobe contains hearing center. This also of importance for the storage process in the long term memory. The visual centre is situated in the occipital lobe which is in the backside of brain. In the anterior part of the parietal lobe

contains the sensory centre where the sensory nerves are terminated. Cerebellum consists of two hemispheres. They regulate the coordination of muscular movement by the cerebrum. It is also a balance center.

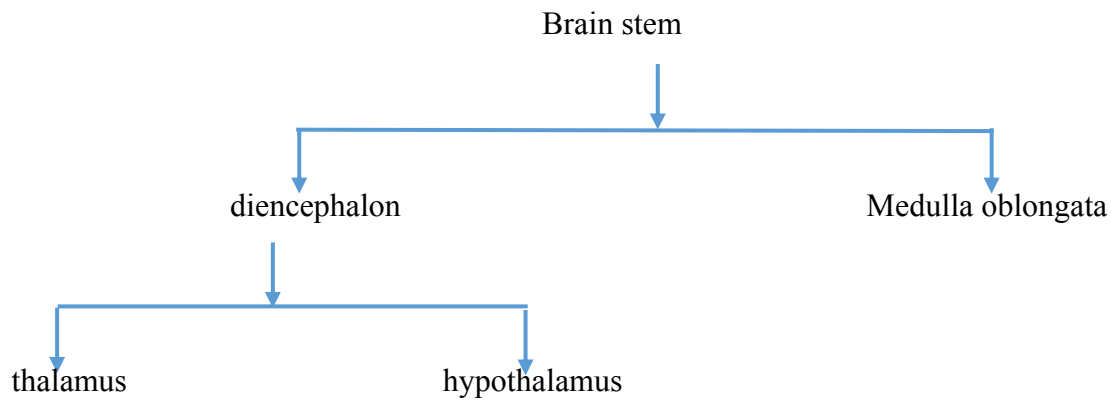
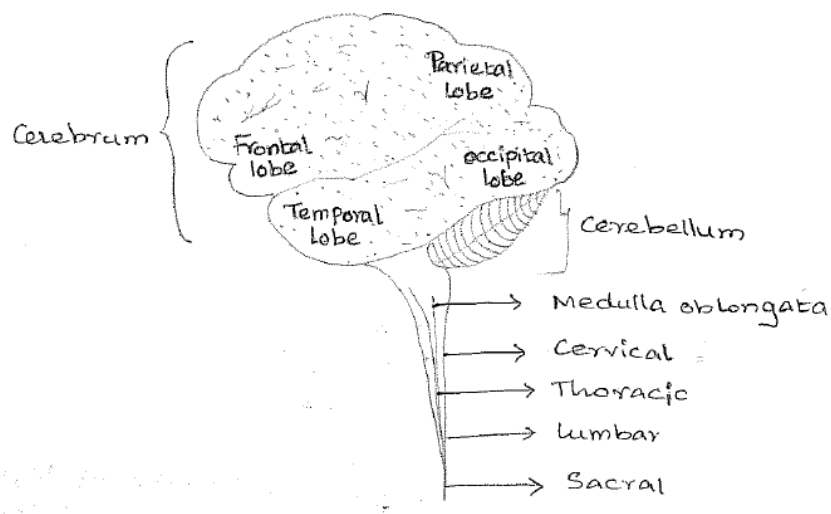

**Figure 1.6 Flow chart**

**Thalamus:** is a relay station of sensory pathways to the cortical sensory center of the cerebrum. **Hypothalamus:** consists of centers for temperature regulation, metabolism, fluid regulation, appetite, thirst, sleep, feelings and emotions. **Medulla oblongata:** contains centers for regulating the working of the heart and lungs.

The brain consists of a system of cavities called ventricles. The ventricles contains cerebro spinal fluid which helps to resist the stresses due to acceleration. Spinal cord is the downward continuation of the medulla oblongata and is protected by the spinal canal. It runs through the vertebral column or through the back bone. The working of the entire body is linked with it. It is connected to a large number of nerves. The spinal cord makes the work of the brain easy by receiving messages from it and then sending them to different organs and vice versa. The spinal cord is meant to take decisions where no thinking is required.

## HUMAN BRAIN



**Figure 1.7 Human Brain**

## ANATOMY OF HEART

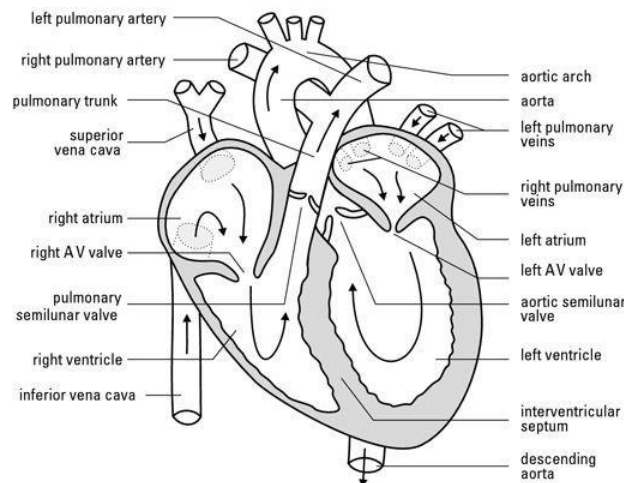

Figure 1.8 Anatomy of Heart

## PHYSIOLOGY OF THE HEART

The heart is divided into **four chambers**. The top two chambers are **atria** and lower two chambers are **ventricles**. The **right atrium receives blood** from the veins and **pumps it into right ventricles**. The **right ventricle pumps the blood into the lungs** where it is **purified and oxygenated**. The oxygen **enriched blood enters the left atrium** from which **it is pumped into the left ventricle**. Then the **left ventricle pumps the blood into arteries through Aortic valve** for **circulation throughout the body**. For circulation, blood requires **proper pressure** sufficient pressure is delivered **by the ventricular muscle's contraction**.

## ELECTRICAL CONDUCTING SYSTEM OF HEART

Each **action potential in the heart** originates at the sinatrial node (**SA node**) which is situated in the **wall of the right atrium** and near the entry of the vena cava. It is also called **cardiac pacemaker**. Which generate impulses at the normal rate of the heart, about **70 beats per minute** at rest. The rate is **governed by the autonomic nervous system**, being **increased by sympathetic nerves** and decreased by the **parasympathetic nerves**. These are connected with brain **through the spinal cord**. The **action potential contracts the atrial muscle** and the impulse spreads through the atrial wall during a period of about 0.04 sec to the atrio-ventricular (AV) node. The node is located in the **lower part of the wall between the two atria**. The **AV node delays the spread of excitation** for about 0.11 second. Thus the AV node acts as a **“delay line”** to provide timing between the action of atria and ventricles. Then a special conduction system carries the action potential to the ventricular muscles. This system consists of a short common part (the bundle of H is, two bundle branches on each of the septum and fine purkinjie fibers. Thus, the atria and ventricles are functionally linked only by the Ar node and the conduction system.

### Cardiac cycle is divided into

1. **Systole:** Contraction of heart - Blood being pumped into the aorta for circulation throughout the body.
2. **Diastole:** Relaxation or dilation of heart - Heart cavities being filled with blood through the superior and inferior vena cavae.



## PHYSIOLOGY OF KIDNEY

The **urinary system** of man which is the **excretory system** consists of **kidney, ureters, urinary bladder and urethra**. The **kidney is the chief excretory organ** which helps in removal of nitrogenous waste materials. **Ammonia and urea** are **chief nitrogenous wastes** produced during metabolism. Both **urea and ammonia** are **taken to the kidney by the blood stream** and the **kidney excrete urea and ammonia in the urine** along with uric acid, salts and water. The kidneys are **dark red, bean shaped paired structures** placed one on either side of the median vertebral column in the lumbar region. Each kidney is about **11 cm in length, 6 cm in breadth and 3 cm in thickness**. Each kidney of the human adult weighs about **150 gms** and is about the size of a clenched fist. Each kidney is about 11 cm in length, 6 cm in breadth and 3 cm in thickness.

Each kidney of the human adult weighs about 150 gms and is about the size of a clenched fist. The **right kidney is on a slightly lower level than the left**. This is because the right side of the abdominal cavity is **occupied by the liver**. Each kidney of the human is **covered by a tough transparent membrane, the fibrous capsule**. **Outer surface** of the kidney is **convex** while the **inner is concave**. The two major regions of the kidney are the **outer dark cortex and pale inner medulla**. The medulla is divided into **multiple cone shaped masses of tissue** called **renal pyramids**. The base of each pyramid originates at the border between the cortex and medulla. (The medulla is divided into multiple cone shaped masses of tissue called renal pyramids.)

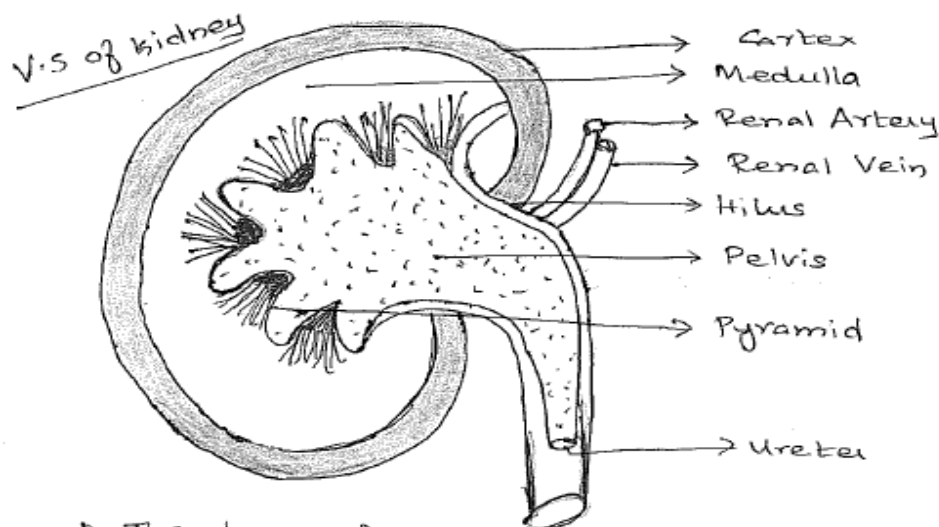

**Figure 1.9 VS of Kidney**

The base of each pyramid originates at the border between the cortex and medulla and it terminates in the papilla, which projects into the space of the renal pelvis, a funnel shaped continuation of the upper end of the ureter. Each kidney is made of a **number of nephrons**. These nephrons are structural and functional units of the kidneys.

## Structure of Nephron

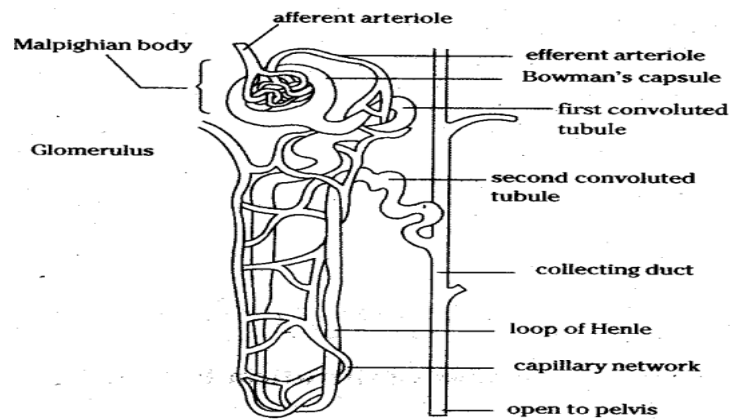

**Figure 1.10 Structure of Nephron**

An individual nephron consists of a **cup shaped malpighian corpuscle** and a renal tubule. The **head part of the malpighian corpuscle lie in the cortex region of the kidney**, and the **renal tubules are placed on the medulla**. The malpighian corpuscle consists of a round cup shaped structure called **Bowman's capsule**. The wall of the Bowman's capsule comprises of a ball of finely divided blood capillaries called the **glomerulus**. The wall of the Bowman's capsule consists of a **single layer of flat cells** having **minute pores**. From the malpighian corpuscles arises the renal tubule. The renal tubule is **partly convoluted and partly straight**.

The renal tubule can be distinguished into 3 regions namely

- (i) Proximal convoluted tubule
- (ii) Henle's loop
- (iii) Distal convoluted tubule

Proximal convoluted tubule is composed of a single layer of columnar epithelial cells. The proximal convoluted tubule extends in the form of a hair pin like structure called Henle's loop. Henle's loop continues in the form of distal convoluted tubule which leads to a collecting tube. The collecting tubules open into a larger tubule called the duct of Bellini which in turn opens into the pelvis.

## HUMAN RESPIRATORY SYSTEM

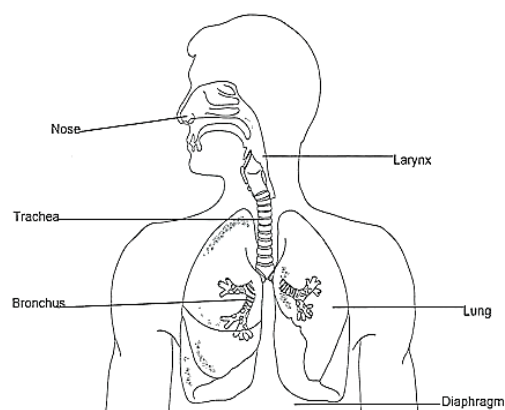

**Figure 1.11 Human Respiratory System**

## PHYSIOLOGY OF THE LUNG

The human body takes in oxygen, which combines with hydrogen, carbon and various other nutrients to produce heat and energy to perform work. The entire process of taking in oxygen from the environment, transporting the oxygen to the cells, removing carbon-di-oxide from the cells and exhausting it to the atmosphere is called as respiration.

Respiration  $\longrightarrow$  exchange of gases.

### External Respiration

The exchange of gases between the blood and the external environment take place in the lungs and is termed as external respiration.

### Internal Respiration

Internal respiration is the respiration of the cells or it is the intracellular use of O<sub>2</sub> to make ATP (Adenosin triphosphate). Lung is the organ responsible for respiration.

### Structure of Respiratory System

The lung is the chief respiratory organ. It is enclosed in the thoracic cage which is composed of the sternum in front, the vertebral column in the back, the ribs encircling the chest & the diaphragm below. Air enters the lungs through the air passages which include the nasal cavities, pharynx, larynx, trachea, bronchi, bronchioles. The lung is in a pair namely right and left. The right lung consists of 3 lobes (upper, middle & lower) and the left lung has 2 lobes (upper & lower). The larynx or the voice box which contains the vocal chords is connected to the bronchi through the trachea, the wind pipe. Above the larynx is the epiglottis, a valve that closes whenever a person swallows, so as to avoid food or liquid to enters the larynx & trachea. The trachea is about 1.5 to 2.5 cm diameter 4.11 cm long. There it divides into right and left bronchi.

Each bronchus enter into the corresponding lung and divides into small branches. The small tubes which are helpful in air conduction are called the bronchioles. Alveoli are attached to the walls of the lungs. They act as the air sacs. The exchange of gases take place at the alveolus. The lungs are covered by a thin membrane called the pleura. The diaphragm is a special dome or bell shaped muscles located at the bottom of the thoracic cavity.

During inspiration  $\rightarrow$  Air flowing in from atmosphere  $\rightarrow$  As the diaphragm muscles contracts the lungs expand.

During expiration  $\rightarrow$  Air flowing out to atmosphere  $\rightarrow$  diaphragm muscles relaxed - lungs compressed.



**SATHYABAMA**

INSTITUTE OF SCIENCE AND TECHNOLOGY  
(DEEMED TO BE UNIVERSITY)

Accredited "A" Grade by NAAC | 12B Status by UGC | Approved by AICTE

[www.sathyabama.ac.in](http://www.sathyabama.ac.in)

**SCHOOL OF ELECTRICAL AND ELECTRONICS**

**DEPARTMENT OF ELECTRICAL AND ELECTRONICS**

**UNIT – II - Biomedical Instrumentation – SIC1311**

## BIO POTENTIAL ELECTRODES AND TRANSDUCERS

Design of Medical Instruments - Components of Biomedical Instrument System - Electrodes: Micro Electrodes, Needle Electrodes, Surface Electrodes -Instrumentation amplifier - Biomedical Measurements Like pH, PCO<sub>2</sub>, PO<sub>2</sub> of Blood, Isolation Amplifier, Preamplifier, Current Amplifier, Chopper Amplifier.

### DESIGN OF MEDICAL INSTRUMENTS

When we design any medical instrument, the following factors should be considered

1. Accuracy
2. Frequency response
3. Hysteresis
4. Isolation
5. Linearity
6. Sensitivity
7. Signal-to-noise ratio
8. Simplicity
9. Stability
10. Precision

(1) **Accuracy** is the closeness with which an instrument reading approaches the true value of the variable being measured. The accuracy can be increased by proper calibration of the equipment and choosing the high precision equipment. (2) **Frequency response** of an instrument is the response of the instrument for various frequency components present in a physiological signal. An instrument should display the original biosignal with higher fidelity.

(3) **Hysteresis:** Mechanical friction present in an analog indicating meter can cause the movement of the indicating needle to lag behind the corresponding changes in the measured variable. This produces hysteresis error in the measured value. Therefore the needle should be selected from the perfect elastic material and its properties should not be affected by its environment. (4) **Isolation:** between the subject, on which the measurements are made and ground is necessary for reasons of electrical safety and to avoid any interference between different instrument used simultaneously. Using isolated circuits, the instrument does not produce a direct electrical connection between the patient and ground.

(5) **Linearity:** of an instrument is defined as the degree to which variations in the output of an instrument follow input variations. (6) **Sensitivity:** of an instrument is the ability of that instrument to detect even a very small change that is taking place in the input. The sensitivity is also expressed in terms of resolution of the instrument which is the minimum variation that can be accurately measured. (7) **Signal to Noise Ratio (S/N):** Since the magnitudes of the biosignals are very low, the S/N ratio should be very high to get reliable information about the input. Therefore the preamplifiers in the biomedical recorders are made up of differential amplifiers which have higher signal to noise ratio.

(8) **Simplicity:** of an instrument is an essential one to eliminate the human errors. Complicated devices result come confusion when we are operating them and hence the uncertainty in the measurement may be large. (9) **Stability:** of an instrument is the ability of that instrument to produce constant o/p for a given i/p. The drift in the amplifiers decreases the stability. Stability is maintained by providing negative feedback. (10) **Precision:** is the measure of the reproducibility of the measurements. It is the degree of agreement within a group of measurements.

## COMPONENTS OF THE BIOMEDICAL INSTRUMENT SYSTEM

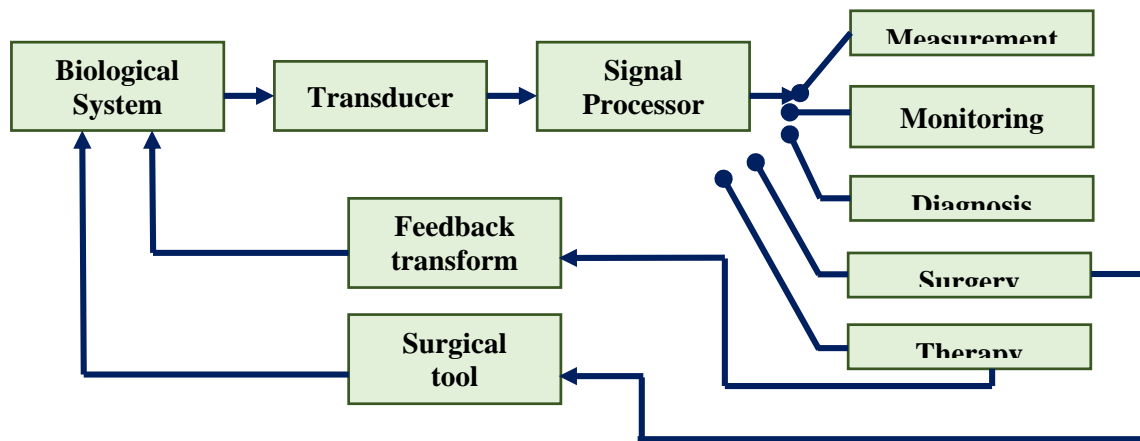

Figure 2.1 Components of the Biomedical Instrument System

The medical instruments shown in figure are those that may be used in **connection with the patient**. Each switch position connects an instrument for measurement, for **monitoring, for diagnosis, for therapy or for surgery** with the signal processor. A transducer is a device capable of **converting one form of energy or signal to another such that its o/p is always an electrical signal** and it can act as an impedance matching device between the biological system and the signal processor. Signal processor is also called **signal conditioning equipment**. In the **case of therapy**, it must feedback the signal to the biological system through the feedback transform. In case of surgery, a surgical tool, like **electrosurgical knife and laser**, is in contact with the biological system.

## ELECTRODES

Biopotential electrodes are those which help in **picking up the electrical signals of the body**. These electrical signals are a **consequence of the chemical activity** in the biological system. Chemical activity are due to ions and this chemical activity takes place at cellular level. Ions like  $\text{Na}^+$ ,  $\text{Cl}^-$ ,  $\text{K}^+$  are predominantly present. The concentration gradient and its unbalanced condition inside and outside the cell leads to electrical activity, which is **picked up by biopotential electrodes**.

## TYPES OF ELECTRODES

Table 2.1 Types of Electrodes

ICRO ELECTRODES	DEPTH AND NEEDLE ELECTRODES	SURFACE ELECTRODES
<ul style="list-style-type: none"> <li>➤ Measures biopotential within a <b>single cell</b></li> <li>a) Metal micro electrode</li> <li>b) Micro pipet</li> </ul>	<ul style="list-style-type: none"> <li>➤ Measures biopotential at highly <b>localised extracellular region</b></li> <li>a) Depth</li> <li>b) Needle</li> </ul>	<ul style="list-style-type: none"> <li>➤ Measures potentials available from the <b>surface of the skin</b>.</li> <li>a) Metal plate</li> <li>b) Suction cup</li> <li>c) Adhesive tape</li> <li>d) Multipoint</li> <li>e) Floating</li> </ul>

## HALF CELL POTENTIAL

Voltage developed at **electrode – electrolyte interface** is called half cell potential or **electrode potential**. In the case of a metal – solution interface, an electrode potentials results from **the difference in rates between two opposing processes**. (a) The **passage of ions** from the **metal into the solution** and (b) The **combination of metallic ions in solution with electrons** in the metal to form atoms of metal. So when a metal electrode comes into contact with an **electrolyte (body fluid)**, there is a tendency for the electrode to discharge ions into solution and for ions in the electrolyte to combine with the electrode.

The net result is the creation of a charge gradient, the spatial arrangement of which is called the electrical double layer. Electrodes in which **no net transfer of charge occurs** across the metal electrolyte interface is called as **perfectly polarized electrodes**. Electrodes in which **unhindered exchange of charge is possible** across the **metal electrolyte interface** are called **perfectly nonpolarisable electrodes**. Real electrodes have properties that the between these idealized limits.

## MICRO ELECTRODES

Microelectrodes are used to measure potential near or within a single cell. These electrodes are otherwise called **intracellular electrodes**. These are of **very small diameters** so that they **do not damage cells** during insertion. When a microelectrodes is used to measure the potential of the cell, it is located within the cell while the **reference electrode is situated outside the cell**. The **diameter** of the tip of the microelectrodes ranges from **0.5 to 5 microns**.

There are two types of microelectrodes namely:

- i) Metal microelectrode
- ii) Micropipet (or) Non-metal microelectrode

## METAL MICROELETRODE

These electrodes are made of **fine tungsten or stainless steel wire**. They are formed by electrolytically etching the tip of the tungsten or stainless steel wire to a fine point. This technique is known as **electropointing**. This etched metal wire is then supported by a larger metallic shaft.

This metallic shaft acts as a

- i) Sturdy mechanical support for the **microelectrode**.
- ii) Means of **connecting the microelectrode** to its lead wire.

These electrodes are made of fine tungsten or stainless steel wire. The microelectrode and the supporting shaft is insulated by a polymer material or varnish. The extreme tip of the micro-electrode is left without insulation. The bio electric potential measured is actually the difference in instantaneous potential of the measuring micro electrode and reference electrode.

The bioelectric potential is given by

$$E = E_A + E_B + E_C$$

E → biopotential

$E_A$  → Metal electrode – electrolyte potential at the microelectrode tip.

$E_B$  → Reference electrode – electrolyte potential

$E_C$  → Variable cell membrane potential.

## METAL MICROELECTRODE

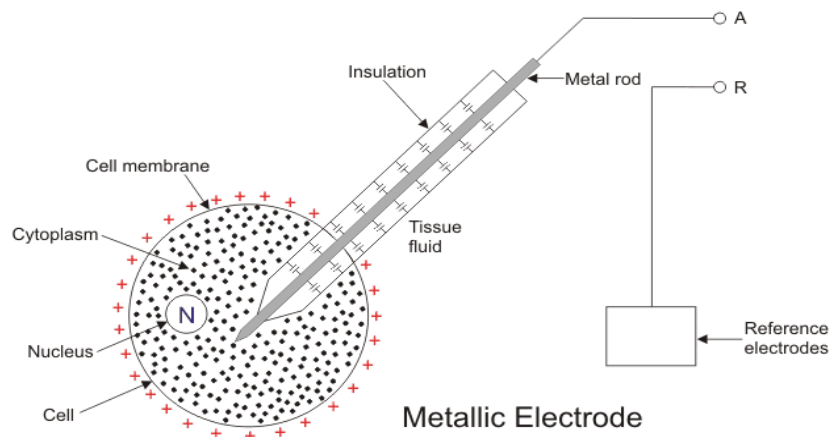

Figure 2.2 Metal Microelectrode

## EQUIVALENT CIRCUIT

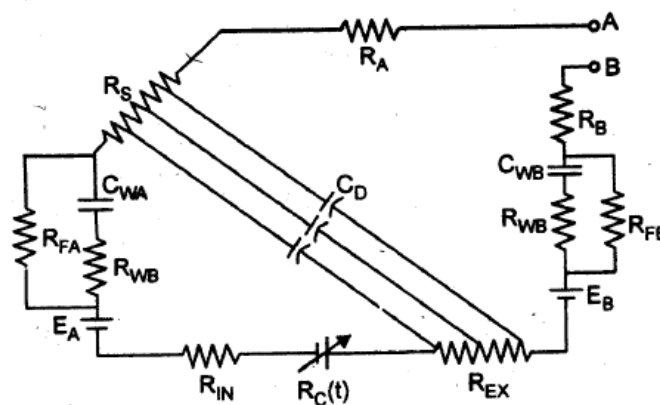

Figure 2.3 Equivalent Circuit

- $R_A$  → Resistance of connecting wire
- $R_S$  → Resistance of shaft of microelectrode
- $R_{IN}$  → Resistance of intracellular fluid
- $R_B$  → Resistance of wire connected to reference electrode
- $R_{EX}$  → Resistance of extracellular fluid
- $C_D$  → Capacitance between insulated shaft of microelectrode and the extracellular fluid.
- $R_{FA}, R_{WA}, C_{WA}$  → Impedance of microelectrode tip.
- $R_{FB}, R_{WB}, C_{WB}$  → Impedance of electrode – extracellular fluid interface.

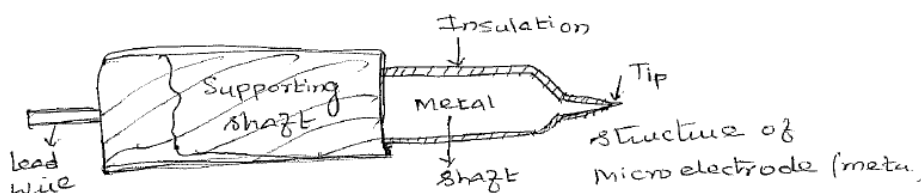

Figure 2.4



## b) MICROPIPET

Micropipet is the other name of the non metal microelectrode. It consists of a glass micropipet whose tips diameter is about 1 micrometer. A thin, flexible metal wire made of silver, stainless steel or tungsten is inserted into the stem of the micropipette. One end of the metal wire is mounted to a rigid support and the other free end through the stem of the micropipette is resting on the cell to pick up bioelectric potential.

$$E = E_A + E_B + E_C + E_D$$

- E → Bioelectric potential
- $E_A$  → Potential between the metal wire and electrolyte filled in micropipette
- $E_B$  → Potential between the reference electrode and the extra cellular fluid
- $E_C$  → Variable cell membrane potential
- $E_D$  → Potential existing at the tip due to different electrolytes present in the pipet and the cell

The micropipette is filled with an electrolyte usually 3M KCL.

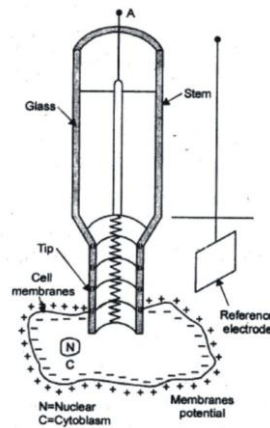

Figure 2.5

## EQUIVALENT CIRCUIT

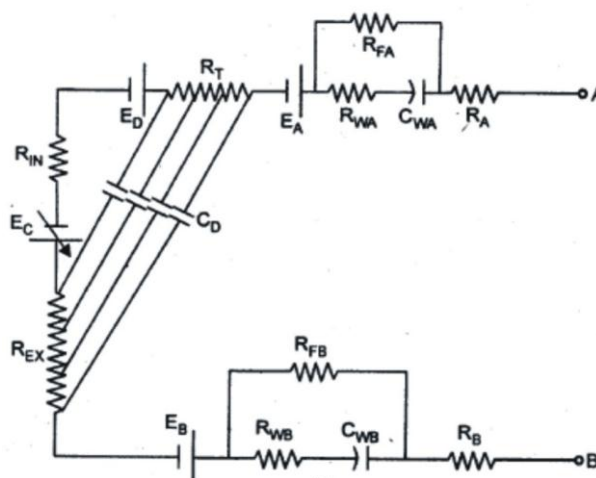

Figure 2.6 Equivalent Circuit

$R_A$	→ Resistance of connecting wire
$R_{FA}, R_{WA}, C_{WA}$	→ Impedance of electrode – electrolyte interface in the stem of the micropipette
$R_T$	→ Resistance of the electrolyte filling the tip of the micropipette
$R_{IN}, R_{EX}$	→ Resistance of electrolyte
$R_{FB}, R_{WB}, C_{WB}$	→ Reference electrode – electrolyte interface impedance
$R_B$	→ Resistance of the wire connected with reference electrode.
$C_D$	→ Capacitance existing between the fluid in the pipet and the extracellular fluid.

## DEPTH AND NEEDLE ELECTRODES

These are used to measure and record bioelectric events from highly localized extracellular regions.

There are two types

- (i) Depth electrodes
- (ii) Needle electrodes

## DEPTH ELECTRODES

Used to study electrical activity of neurons in the superficial layers of the brain. These are made of bundle of Teflon insulated platinum 90% - iridium 10% alloy wires. These wires act as individual electrodes and supported by a stainless steel wire. This stainless steel supporting wire is rounded off at the tip for easy insertion into the top layers of the brain. The electrode rests on the sub cortical nerve cells. The active area of depth electrode is  $0.5 \text{ mm}^2$ . Thus the impedance of depth electrodes is smaller compared to microelectrodes. The supporting stainless steel wire can itself act as an electrode if an appropriate varnish is used. The supporting wire if made in the form of a capillary tube can be used to inject medicines into the brain.

## ELECTRODE

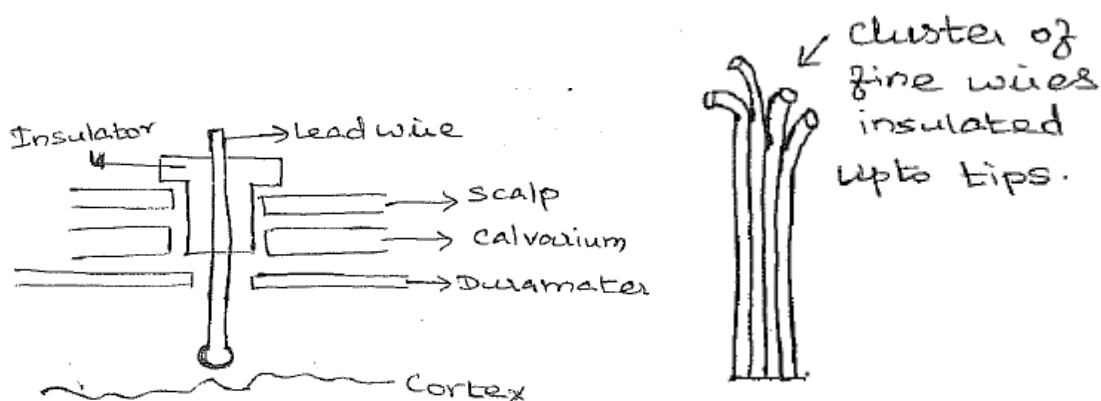
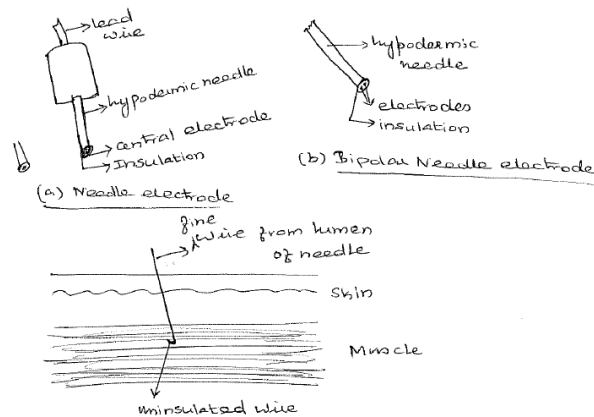

Figure 2.7 Electrode

## NEEDLE ELECTRODE

The needle electrode is used to measure action potentials of peripheral nerves (Electroneurography). Here a needle is used to make a lumen through which a short length metal wire is inserted. This short length metal wire is bent at one end and inserted through the human into the muscles. This wire picks up the electrical activity of the biological system. If one wire is used as a measuring electrode and another separate reference electrode is used then it is called monopolar needle electrode. If two insulated wires are used one as reference and the other as measuring electrode through the lumen of the needle then such an electrode system is called bipolar needle electrode.



**Figure 2.8 Needle Electrode**

## SURFACE ELECTRODES

Surface electrodes are used to record ECG, EMG and EEG signals. Larger surface area: Surface electrodes are used for ECG measurement. Smaller surface area: Surface electrodes are used for EEG and EMG measurement.

### (a) Metal plate surface electrodes

Simplest of all surface electrodes. It consists of a metallic conductor in contact with the skin. It is mostly used as limb electrodes in ECG measurement. It is made up of a flat metal plate that is bent into a cylindrical segment. There is a terminal on the cylindrical segment on its outer surface, to attach the lead wire to the electrocardiograph. There is also a post placed on the same side of the segment near the centre. This post is used to connect a rubber strap to the electrode and hold it in place on an arm or leg. The electrode is generally made of germanium silver, nickel plated steel, nickel etc.

There are basically 2 types of metal plate surface electrodes namely

- (i) Rectangular
- (ii) Circular

The active surface area of a rectangular surface electrode is normally 3.5 cm x 5 cm. The active surface area of the circular surface electrode is 17.6 cm<sup>2</sup> (4.75 cm – diameter). The inner surface of the electrode is covered with or an electrolyte soaked pad is kept which will maintain the electrode contact with the skin. In circular metal disk electrodes the lead wire is soldered to the back surface. The connection between lead wire and electrode is protected by a layer of insulated material such as epoxy or polyvinyl chloride. These electrodes can be used

for both ECG, EMG and EEG recordings. Disk electrodes used for ECG measurements are made of silver and has an electrolytically deposited layer of AgCl on its contacting surface. It is also coated with electrolyte gel and placed on the patients chest wall. Disk electrodes used for EMG recordings are made of stainless steel, platinum or gold plated disks. Disk electrodes also come in the form of disposable thin metal foils which can conform to the shape of the body surface.

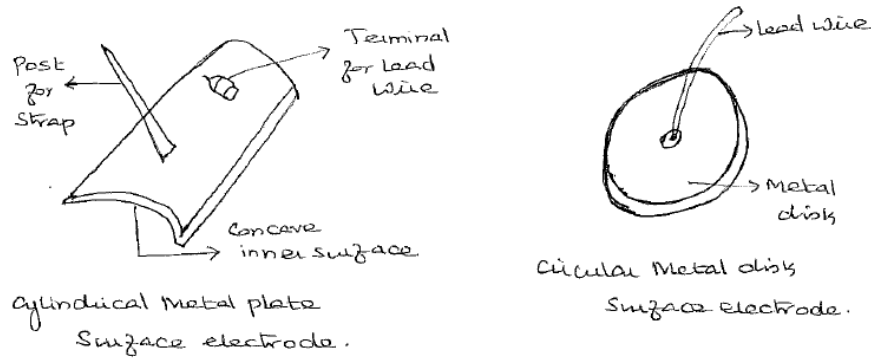

**Figure 2.9 Surface Electrode**

### SUCTION CUP ELECTRODE

Suction cup electrodes can be called as modified metal plate electrodes. These electrodes do not require straps or adhesives to hold them to a particular location. These electrodes are mostly as chest lead electrodes for ECG measurement. They consist of a hollow metallic cylindrical electrode that makes contact with the skin at its base. A terminal is there on the metal cylinder for lead wire attachment. A rubber suction bulb is fitted to the other base of the cylindrical metal electrode. The rubber bulb is squeezed and placed on the body, the bulb releases and applies suction against the skin, thus holding the electrode to the body. This electrode can be used for only short periods of time because the suction and pressure can cause irritation to the skin. Even though the electrode is large, the contact area is small, therefore the impedance is large. These electrodes are generally used for ECG limb electrodes. These electrodes are well suited for attachment to flat surfaces of the body.

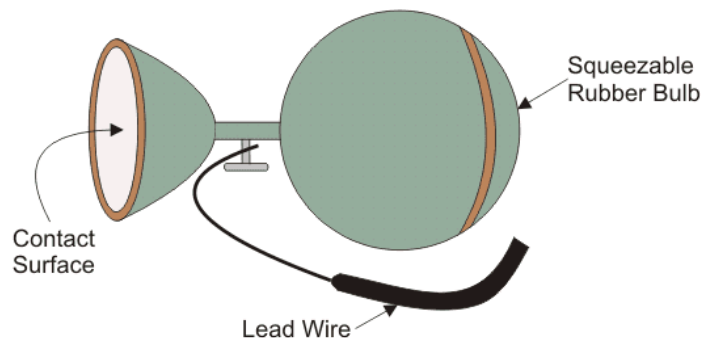
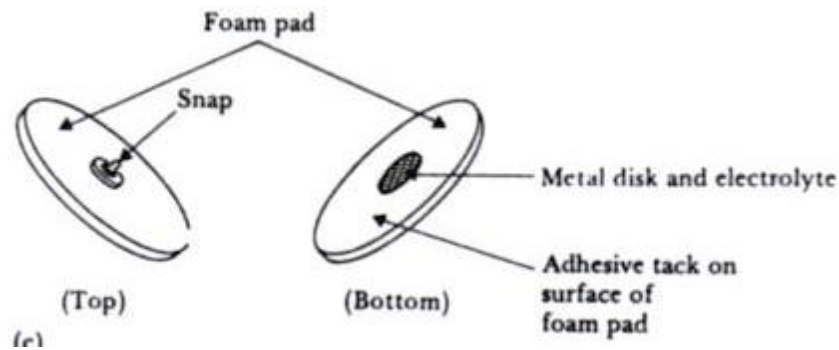

**Figure 2.10 Suction Cup Electrode**

### ADHESIVE TAPE ELECTRODE

When surface electrodes are used, the pressure applied on it across the body squeezes the gel or electrode paste out. Such a problem is avoided with use of adhesive tape electrode.

It consists of a large disk of plastic foam material with a silver plated disk on one side and a silver plated snap on the other side. The silver plated disk serves as the electrode and may be coated with a silver chloride layer. A layer of electrolyte gel covers the disk. A lead wire is snapped onto the electrode and connected to the ECG apparatus. A lead wire is snapped onto the electrode and connected to the ECG apparatus. The electrode side of the foam is covered with an adhesive material, which is covered with a protective foil material. To apply the electrode, the skin is cleaned, the protective material is removed and pressed against the patient.



**Figure 2.11 Adhesive Tape Electrode**

### MULTIPOINT ELECTRODES

Multipoint electrode contains nearly 1000 fine active contact points. Since the active surface area is very small, a very low resistance contact is established in these types of surface electrodes. These type of electrodes are used on subjects where the region of interest is covered with hair. These electrodes can be used under any environmental conditions. The multipoint electrode is a very practical electrode for ECG measurement.

### FLOATING ELECTRODES

In floating electrodes the metal electrode is not in contact with the body, hence motion artifact is avoided. It is also known as top-hat electrode. Here, the actual electrode element or metal disk is kept in a cavity of insulated package. Thus the electrode element does not come in contact with the skin. The electrode element is surrounded by electrolyte gel inside the cavity. The cavity does not move with respect to the metal disk, so it does not produce any mechanical movement. The electrode, electrolyte gel cavity is attached to the skin surface by means of a double sided adhesive tape ring. The electrode disk is made of silver metal and coated with silver chloride.

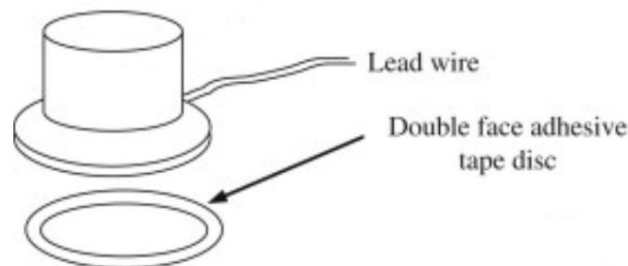

**Figure 2.12 Internal Structure of Floating Electrode**

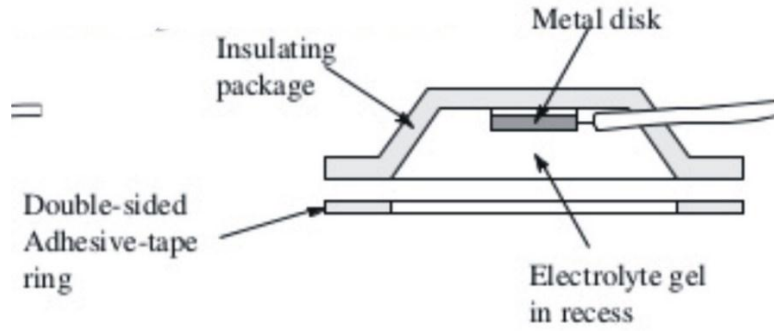

**Figure 2.13** Equivalent circuit of surface electrode

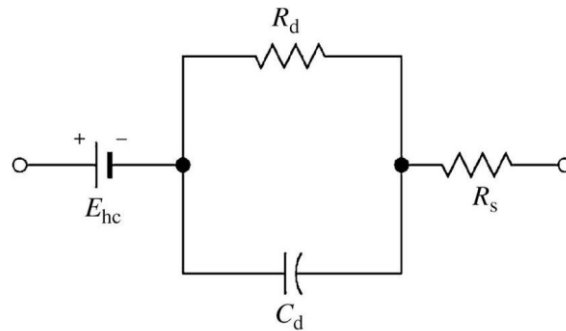

**Figure 2.14**

The impedance of this equivalent circuit is given by

$$z = R_s + \frac{R_d}{1 + j2\pi f c_d R_d}$$

$$z = R_s + \frac{R_d}{1 + j2\pi f c_d R_d}$$

- $E_{hc}$  → half cell potential at electrode – electrolyte surface
- $c_d$  → electrode capacitance
- $R_d$  → leakage resistance
- $R_s$  → electrolyte and skin resistance



**SATHYABAMA**

INSTITUTE OF SCIENCE AND TECHNOLOGY  
(DEEMED TO BE UNIVERSITY)

Accredited "A" Grade by NAAC | 12B Status by UGC | Approved by AICTE

[www.sathyabama.ac.in](http://www.sathyabama.ac.in)

**SCHOOL OF ELECTRICAL AND ELECTRONICS**

**DEPARTMENT OF ELECTRICAL AND ELECTRONICS**

**UNIT – III - Biomedical Instrumentation – SIC1311**

## INSTRUMENTS USED FOR DIAGNOSIS

ECG, Einthoven Triangle, Leads, Electrodes, Vector Cardiograph, Measurement of Cardiac Output, EEG, EMG, Plethysmography, Blood Flow Measurements, Holter Monitor-Respiratory Rate Measurement - Oximeter, Patient Monitoring System, ICCU.

### INSTRUMENT USED FOR DIAGNOSIS

#### ECG

The electrocardiography (ECG) deals with the study of the electrical activity of the heart muscles. The potentials originated in the individual fibers of heart muscle are added to produce the ECG waveform. Electro cardiogram is the recorded ECG wave pattern. An instrument used to obtain and record the electrocardiogram is called an electro cardiograph. The electrocardiogram reflects the rhythmic electrical depolarisation and repolarisation of the myocardium (heart muscle) associated with the contractions of the atria and ventricles. The shape, time interval and amplitude of the ECG give the details of the state of the heart. Any form of arrhythmia (disturbances in the heart rhythm) can be easily diagnosed using electrocardiogram. For diagnosis, cardiologist look first at the heart rate. The normal value lies in the range of 60 to 100 beats per minute. A slower rate than this called bradycardia & a higher rate, tachycardia.

#### ELECTROCARDIOGRAM

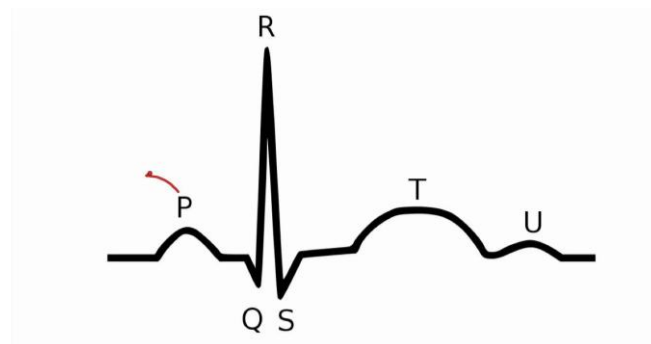

**Figure 3.1 Electrocardiogram**

It consists of P wave QRS complex and T wave. The origin, amplitude & duration of the different waves in the electrocardiogram 'are'

**Table 3.1**

	<b>Origin</b>	<b>Amplitude mV</b>	<b>Duration sec</b>
P wave	Atrial depolarisation or contraction	0.25	0.12 to 0.22 P – R interval
R wave QRS complex	Repolarisation of the atria & the depolarisation of the ventricles	1.60	0.07 to 0.1
T wave	Ventricular repolarisation	0.1 to 0.5	0.05 to 0.15 (S – T interval)
S – T interval U wave	Ventricular contraction show repolarisation of the intraventricular	<0.1	0.2 T – U interval



If the PR interval is more than 0.22 sec, the AV Block occurs [first degree – heart attack]. When the QRS complex duration is more than 0.1 second the bundle block occurs. [severe heart attack]

## ECG INSTRUMENTATION

The connecting wires for the patient electrode originate at the end of a patient cable. The wires from the electrode connect to the lead selector switch. A push button allows the insertion of a standardisation voltage of 1mV to standardise or calibrate the recorder. From the lead selector switch the ECG signal goes to pre-amplifiers, which is a differential amplifier with high common mode rejection ratio, high gain factor, high input impedance & low O/P impedance. It is AC coupled to avoid problems with small DC voltages that may originate from polarisation of the electrodes. The preamplifier, is followed by a dc amplifier called the pen-amplifier or power-amplifier, which provides the power to drive the pen motor that records the actual ECG trace. A position control in the pen amplifier makes it possible to centre the pen on the recording paper. ECG recorders use heart sensitive paper, and the pen is actually an electrically heated stylus, the temperature of which can be adjusted with a stylus heat control for optimal recording trace.

**Table 3.2**

	<b>Lead I</b>	<b>Lead II</b>	<b>Lead III</b>
	V <sub>I</sub> mV	V <sub>II</sub> mV	V <sub>III</sub> mV
R wave amplitude	0.53	0.71	0.38
	[0.07 to 1.13]	[0.18 to 1.68]	[0.03 to 1.31]

$$V_{III} \approx V_I + V_{II}$$

## AUGMENTED UNIPOLAR LIMB LEADS

### Introduced by Wilson

The electrocardiogram is recorded between a single exploratory electrode and the central terminal which has potential corresponding to the center of the body. The two equal & large resistors are connected to a pair of limb electrodes and the center of this resistive network acts as central terminal and the remaining limb electrode acts as the exploratory electrode.

The augmented lead connections are

- (i) aVR – augmented voltage right arm
- (ii) aVL – augmented voltage left arm
- (iii) aVF – augmented voltage foot

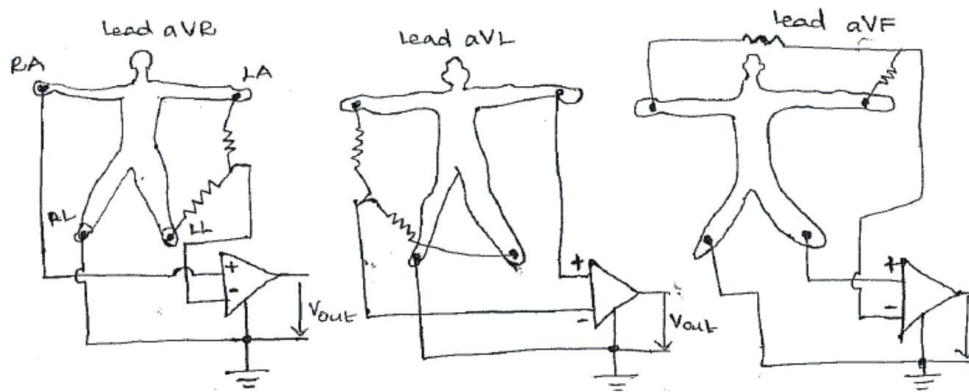

**Figure 3.2**

Eventhough the resistors in these limb leads have large value, their values are smaller when we compare with the input resistance of the preamplifier.

**By Kirchoff's Law**

$$aV_R = -V_I - \frac{V_{III}}{2}$$

$$aV_L = V_I - \frac{V_{II}}{2}$$

$$aV_F = V_{II} - \frac{V_I}{2}$$

**Unipolar Chest Leads**

The exploratory electrode is obtained from one of the chest electrodes. The chest electrodes are placed on the six different points on the chest closed to the heart.

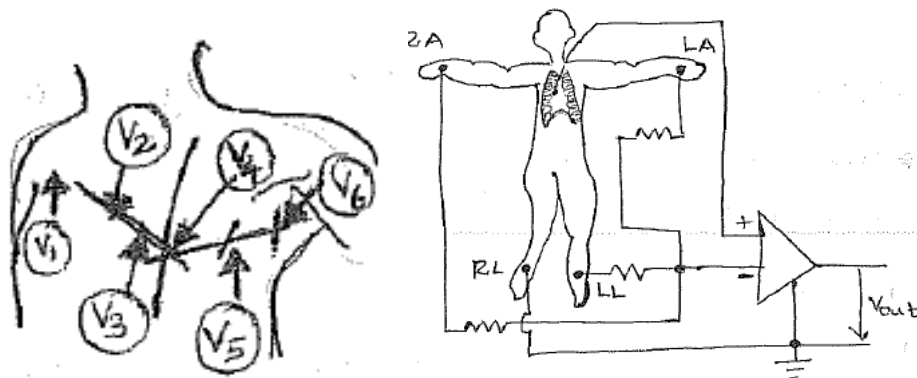

**Figure 3.3 Unipolar Chest Leads**

- V<sub>1</sub> – Fourth intercostal space at right sternal margin
- V<sub>2</sub> – Fourth intercostal space at left sternal margin
- V<sub>3</sub> – Midway bet V<sub>2</sub> & V<sub>4</sub>
- V<sub>4</sub> – Fifth intercostal space at mid-clavicular line
- V<sub>5</sub> – Same level as V<sub>4</sub>, on anterior axillary line
- V<sub>6</sub> – Same level as V<sub>4</sub>, on mid-axillary line.

By connecting three equal large resistances to the left arm, right arm and left leg a reference electrode or central terminal is obtained. This lead system is known as **Wilson system**. Thus electrocardiograms are recorded from these 12 lead sections such that

- 3 standard bipolar leads
- 3 augmented unipolar leads
- 6 chest leads

The ECG potentials are measured with colour coded leads

- White - Right arm
- Black - Left arm
- Red - Left arm
- Brown - Chest

This is internationally adopted for easy reference

### **Frank Lead System**

The corrected orthogonal leads system (or) Frank Lead System is used in vector cardiography. Get the information from above said 12 leads and hence the state of the heart is studied three dimensionally.

### **VECTOR CARDIOGRAPH**

In the case of electrocardiography only the voltage generated by the electrical activity of the heart is recorded. But in vector cardiography, the cardiac vector is displayed along with its magnitude and spatial orientation. Even though the cardiac vector is a 3 dimensional, its projections on orthogonal planes converts it into 2 dimensional vector. Special lead placement systems must be used to pick up the ECG signals for vector cardiograms, the Frank system is most frequently employed. The vector cardiogram is usually displayed on a cathode-ray oscilloscope (CRT). The vector cardiogram appears as Loops in each plane. The planes are the frontal, sagittal and transverse planes. There are three loops corresponding to P, QRS and T waves. Among these the QRS complex loop is a dominating one. Each QRS complex is displayed as a sequence of loops on this screen (CRO), which is then photographed with a polaroid camera to provide a permanent record.

### **ELECTROENCEPHALOGRAPHY (EEG)**

EEG deals with the recording and study of electrical activity of the brain. By means of scalp electrodes attached to the skull of a patient, the brain waves can be picked up and recorded. The brain waves are the summation of neural depolarisation in the brain due to stimuli from the five senses as well as from the thought processes. During recording, the electrodes are placed around the frontal, parietal, temporal and occipital lobes of the brain. Electroencephalogram is the record of the brain waves made by an electroencephalograph.

## BRAIN WAVES

Brain waves can be classified into alpha, beta, theta and delta waves.

**Table 3.3 Brain waves**

Waves	Frequency	Occurrence
1. Alpha waves	8 – 13 Hz	<ul style="list-style-type: none"><li>➤ Found in normal persons when they are awake in a quiet, resting state.</li><li>➤ They occur normally in occipital region.</li><li>➤ During sleep, these disappear amplitude → 20 – 200 <math>\mu</math>V.</li></ul>
2. Beta waves	13-30 Hz	<ul style="list-style-type: none"><li>➤ Recorded from the parietal &amp; frontal region of the scalp.</li></ul>
3. Theta waves	4-8 Hz	<ul style="list-style-type: none"><li>➤ Recorded from parietal &amp; temporal region of the scalp of children.</li><li>➤ Occur during emotional stress in some adults during disappointment &amp; frustration.</li></ul>
4. Delta waves	0.5-4 Hz	<ul style="list-style-type: none"><li>➤ Occur only once in every 2 or 3 sec.</li><li>➤ Occur in deep sleep, in premature babies &amp; in very serious organic brain diseases.</li></ul>

## INSTRUMENTATION

Electro encephalography deals with the recording and study of electrical activity of the brain. By means of electrodes attached to the skull of a patient, the brain waves can be picked up and recorded. Electrical potentials of the brain are due to gradient in concentration of dendrite graded potentials. EEG recording set up includes the patient cable consisting of 21 electrodes and is connected to the eight channel selector. Every channel of the channel selector consists of an individual, multistage, ac coupled, differential, adjustable gain amplifier. These amplifiers must have high gain and low noise characteristics since EEG potentials are in arrange. The amplifier must be free from drift so as to prevent the slow movement of recording pen. The EEG signal frequency ranges between large values so it becomes necessary to use set of filters including low pass, high pass and band pass. The amplified EEG signals are passed through this filter bank.

Typical cut off frequencies for

Low pass filters → 5.3, 1.6, 0.53 & 0.15 Hz

Band pass filters → 60 Hz

High pass filters → 15, 30, 70, 300 Hz

The o/p voltage from the amplifier may either be applied directly to the eight channel display through the filter bank or it may be stored as data on a tape recorder or computer memory for further processing. There are other facilities available to record evoked potentials from the brain due to external stimuli like visual stimulus, audio stimulus and tactile stimulus. The time delay between the stimulus and response can also be measured in the signal processing unit.

EEG helps in diagnosing disorders or abnormalities related to brain such as

- **Tumors** → electrical activity absent in part of hemisphere.

- **Epilepsy** → symptom of brain damage due to defects in the birth delivery or head injury during accident
- **Sleep disorders** → discharge of large groups of neurons also due to brain tumor

### ANALYSIS OF EEG

EEG changes with the level of consciousness.

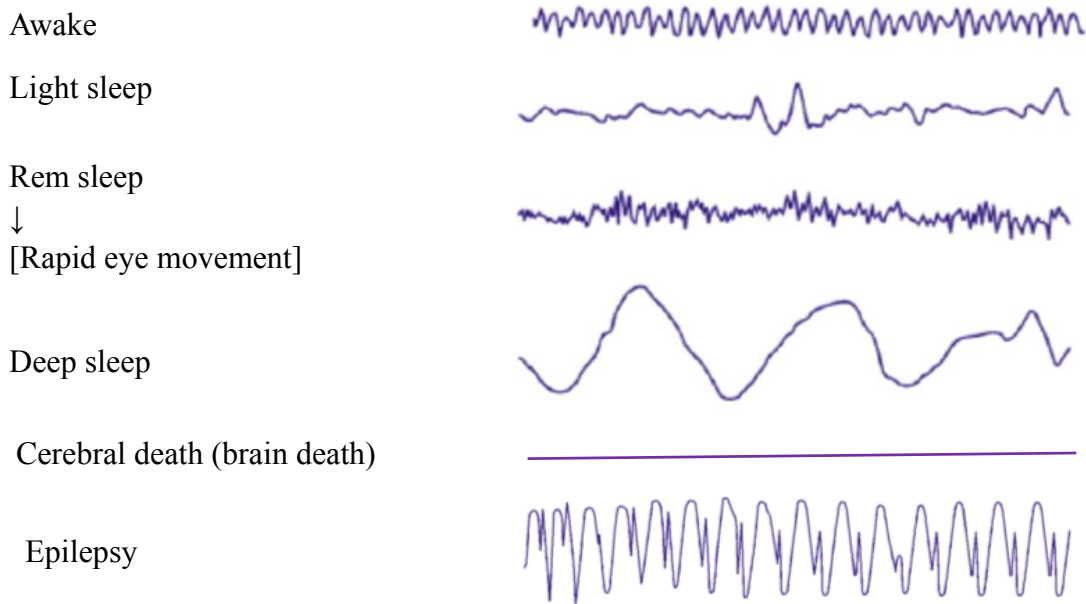

**Figure 3.4 Analysis of EEG**

### EEG BLOCK DIAGRAM

EEG changes with the level of consciousness.

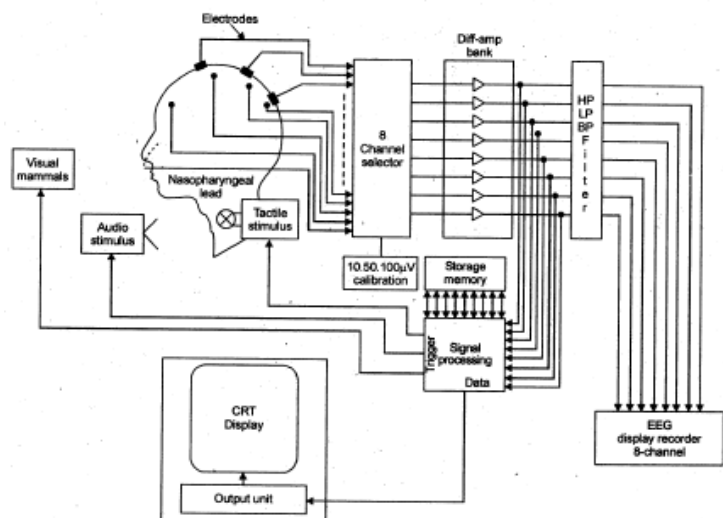
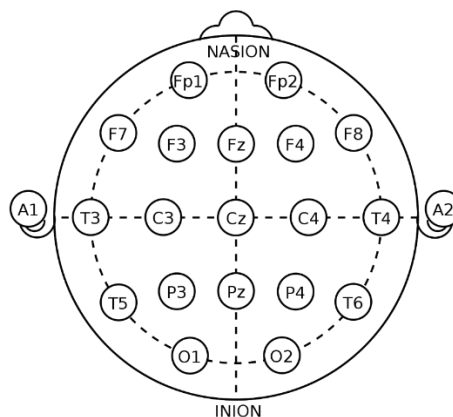

**Figure 3.5 EEG Block Diagram**

## EEG ELECTRODE SYSTEM

The commonly used electrode system for recording EEG signals is termed as 10-20 electrode system. The electrode are placed at a distance of 10% and 20% approximately from the total distance between the extreme end points of the skull namely nasion, inion, right and left ear lobes. This type of system is also called montage electrode system. In this system electrodes are placed symmetrically on both sides of the skull. Both bipolar and unipolar system can be used. In bipolar the difference in potential between two neighbouring electrodes are considered. For unipolar type the reference electrodes are placed on the non-active part of the head like forehead or on the ear lobes. Firstly the distance between nasion and inion is determined and the distance between the right and left ear lobe is also determined. The central electrode is placed at the intersection of the imaginary lines joining nasion and inion and right ear, left ear.

### 10-20 Electrode System / Montage Nasion



Right – Even numbers

Left – Odd numbers

**Figure 3.6 10-20 Electrode System/ Montage Nasion**

## ELECTRO MYOGRAHPHY (EMG)

Electromyography is the instrument for recording and interpreting the electrical activity of muscle action potential. The electrical activity of the underlying muscle can be measured by placing surface electrodes on the skin. To record the action potential of individual motor unit the needle electrode is inserted into the muscle. EMG indicates the amount of activity of a given muscle or a group of muscles. EMG waveform appears like a random noise signal. Contraction of a muscle produces action potential. When a muscle is relaxed there is no action potential. The surface of the skin is cleaned and electrode paste is applied. The electrodes are kept in place by means of elastic bands. The cup is tightly sealed to the member to be measured so that any changes of volume in the limb or digit reflect as pressure changes inside the chamber. Either fluid or air can be used to fill the chamber.

Plethysmographs may be designed for constant pressure to constant volume within the chambers. In either case, some form of pressure or displacement transducer within the chamber and to provide a signal changes within the chamber and to provide a signal that can be calibrated to represent the volume of the limb or digit. The baseline pressure can be calibrated by use of a calibrating syringe. This type of plethysmograph can be used in two ways. If the cuff, placed upstream from the seal, is not inflated, the output signal is a simply a sequence of pulsations proportional to the individual volume changes with each heart beat. The

plethysmograph can also be used to measure the total amount of blood flowing into the limb or digit being measured. By inflating the cuff (placed slightly upstream from the seal) to a pressure just above venous pressure, arterial blood can flow past the cuff but venous blood cannot leave. The result is that the limb or digit increases its volume with each heartbeat by the volume of the blood entering during the beat. The output tracing for this measurement is shown in figure.

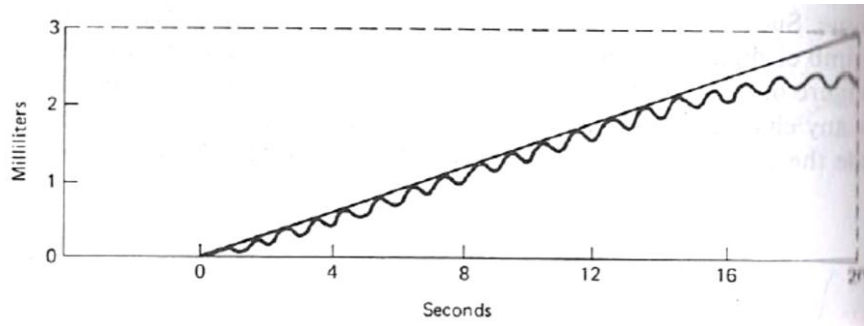

**Figure 3.7 Blood volume record from plethysmograph**

The slope of a line along the peaks of these pulsations represents the overall rate at which blood enters the limb or digit. However after a few seconds the slope tends to level off. This is caused by a back pressure that builds up in the limb from the accumulation of blood that cannot escape.

## **MEASUREMENT OF CARDIAC OUTPUT**

Cardiac output is the amount of blood delivered by the heart to the aorta per minute. During each beat, in the case of adults, the amount of blood pumped ranges from 70 to 100 ml and hence for normal adults the cardiac output is about 4-6 litres / minute. The measurement of cardiac o/p is necessary to study the various cardiac disorders. Decrease in cardiac o/p may be due to low blood pressure, poor renal function, shock etc.

### **Indicator Dilution Method**

The volume flow of the blood from the heart can be estimated by introducing a known amount of indicator and measuring the concentration of the indicator with respect to time at the measurement site. Let  $M$  mg of an indicator be injected into a large vein or preferably into the right heart itself. After passing through the right heart, lungs and the left heart, the indicator appears in the arterial circulation. The presence of the indicator in the peripheral artery is detected by a detector / photo electric transducer by drawing the blood from an artery through a measuring chamber where the detector continuously analyses the blood. The indicator is a radio isotope and the concentration is displayed on a chart recorder w.r.t. time. The curve obtained is called the dilution curve.

During the first circulation period, the indicator would mix up with the blood and will dilute just a bit. At the transducer the change in concentration is detected. This shown by the rising portion of the dilution curve. Since the circulation is a closed one, a fraction of injected indicator once again passes through the heart and the arterial circulation. Thus a second peak appears in the curve. When the indicator completely mixes up with blood, the curve becomes parallel to the time axis. The amplitude of the curve depends on the quantity of injected

indicator and on the total quantity of circulating blood. The cardiac o/p can be calculated from the dilution curve.

$$Q = \frac{M \times 60}{\text{Area under curve}} \text{ l/min}$$

Q → cardiac o/p

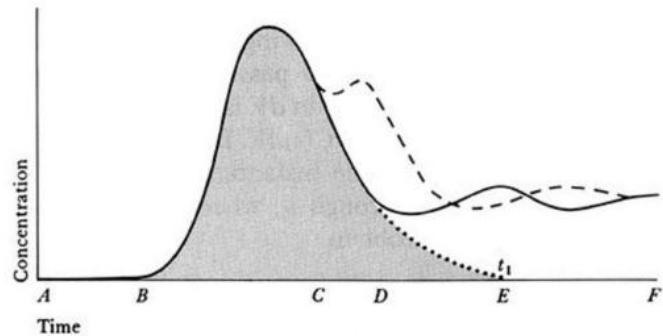

**Figure 3.8 Indicator Dilution Method**

### Dye Dilution Method

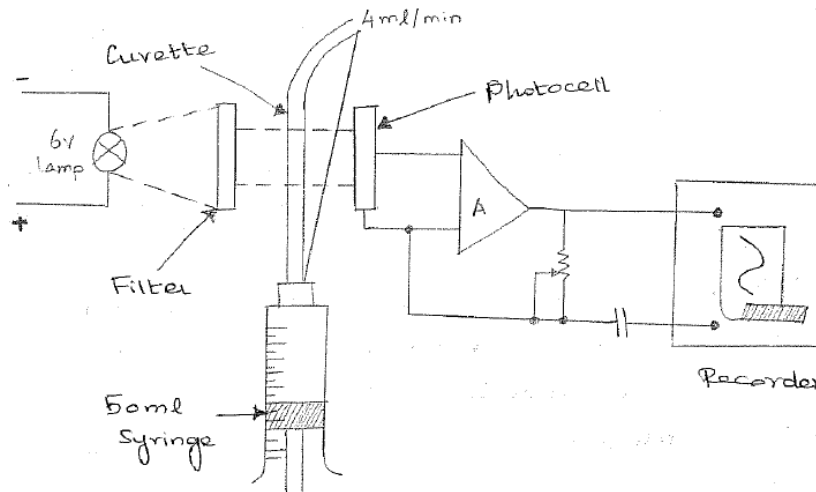

**Figure 3.9 Dye Dilution Method**

In this method, the indicator used is a dye. Indocyanine green or cardiogreen dye is commonly used. This dye is used to record the dilution curve. The concentration of the dye is measured with the help of infra-red photocell. The dye of upto 5 mg is injected and the dye passes through circulation. The blood is drawn from the radial or femoral artery by a motor driven syringe through a cuvette. A radiation source illuminates the cuvette from one side and the detector photocell receives the scattered laser. The curve is made of disposable polyethylene tube. There is an interference filter with a peak transmission of 05 nm which permit only infrared radiation to be transmitted. The o/p of the photocell is connected to a low drift amplifier which was high i/p impedance and low o/p impedance. A potentiometric recorder records the amplifier o/p signal on a recording paper at a speed of 10 mm/s. After recording the dilution curve, saline is injected to flush the dye out of the circulating blood. X-ray radiation intensity is controlled by, Filament heat control (mA) for exposure strength Kilovolt control (kV) for penetration depth. Timing control for exposure time length. After x-ray is generated, it is passed through aluminium filters. The emitted x-rays contain a broad range of frequencies. The unwanted frequencies increase the dose on the patient and decrease image contrast.



**Aluminium filters** absorb lower x-ray frequencies and hence intensity of low frequency x-ray incident on the patient is reduced. After going through aluminium filters, the x-rays are focused by using collimator. **Collimator** is made of a metal shutter with a rectangular or circular hole of suitable size. The hole size is adjustable with lead strips which can be moved relative to each other. There is a lamp and reflective mirror arrangement which makes a visible pattern on the patient where the x-ray is exposed so that the medical attendant can position the patient properly. Then the x-ray transmitted from the patient is passed through the Bucky Grid. The **Bucky Grid** is introduced between the patient and the film cassette to improve the sharpness of the image. This consists of thin lead vanes separated by spacers of low attenuation material. Then the primary radiation with information is passed through image intensifier so that the sharpness is improved further.

## RADIOGRAPHY AND FLUOROSCOPY

In radiography, a radiograph (x-ray picture) is obtained on a photographic film placed in the image plane. In fluoroscopy, the patients condition is viewed on a fluorescent screen which converts x-rays into visible high by scintillations.

**Table 3.4 Radiography and Fluoroscopy**

<b>Radiography</b>	<b>Fluoroscopy</b>
1. X-ray image is developed by photosensitive film	X-ray image is developed by photoelectric effect and fluorescence principle.
2. High geometric resolution in images can be obtained.	Fair resolution in images can be obtained.
3. A wide range of contrast can be obtained.	Contrast can be increased by introducing electronic image intensifier.
4. Patient is not exposed to x-rays during examination of the x-ray image.	Patient is exposed to x-rays during the examination of the x-ray image.
5. The patient dose is low.	The patient dose is high.
6. Permanent record is available	Permanent record can be made by inserting video tape recorder.
7. Image can be obtained after developing the film and the examination cannot be made before developing the film.	Immediately image can be seen and examination can be finished within a short time.
8. Movement of organs cannot be observed.	Movement of organs can be observed.
9. Efficiency is mor	Efficiency is lesser in direct fluoroscopy, with the modern television sys, the efficiency can be increased.

## IMAGE INTENSIFIER IN RADIOGRAPHY

The image intensifier has high atomic number material screens on the top and bottom of the x-ray film. After that there are phosphors above and below the x-ray film and they

introduce secondary visible light radiation by scattering process. The high z screens are used to capture more amount of x-rays. Finally there are silver bromide grains in the film which absorbs the secondary radiation and preserves the x-ray image. In some cases, where high resolution is required, films with denser silver bromide grains are alone used without image intensifying screens.

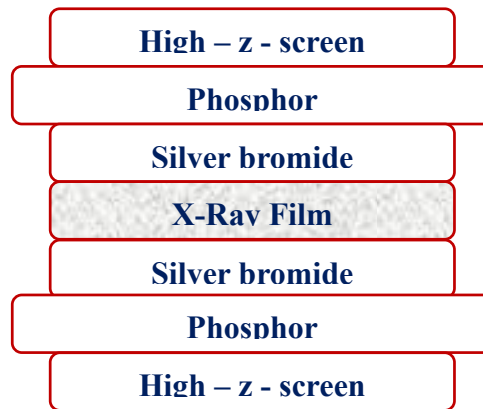

**Figure 3.10 Image Intensifier (Radiography)**

### IMAGE INTENSIFIER IN FLUOROSCOPY

The x-ray image intensifier combines the functions of x-ray detection and light amplification in a single glass envelope. X-rays strike the input screen-usually a layer of cesium iodide-which fluoresces in proportion to the x-ray intensity. The input phosphor is in close proximity to a photocathode, so the light stimulates the emission of electrons. These electrons are accelerated through the 25 kV electric field and focused by shaping the electric field. They strike the output phosphor, which produces an image that is smaller but brighter than that produced at the input phosphor. A lens mounted on the image intensifier serves to collimate or focus the output image to infinity. Another lens is used as the collimating lens which has maximal light gathering power. The objective lens of the camera collects the light of the collimating lens and refocuses it on the film plane.

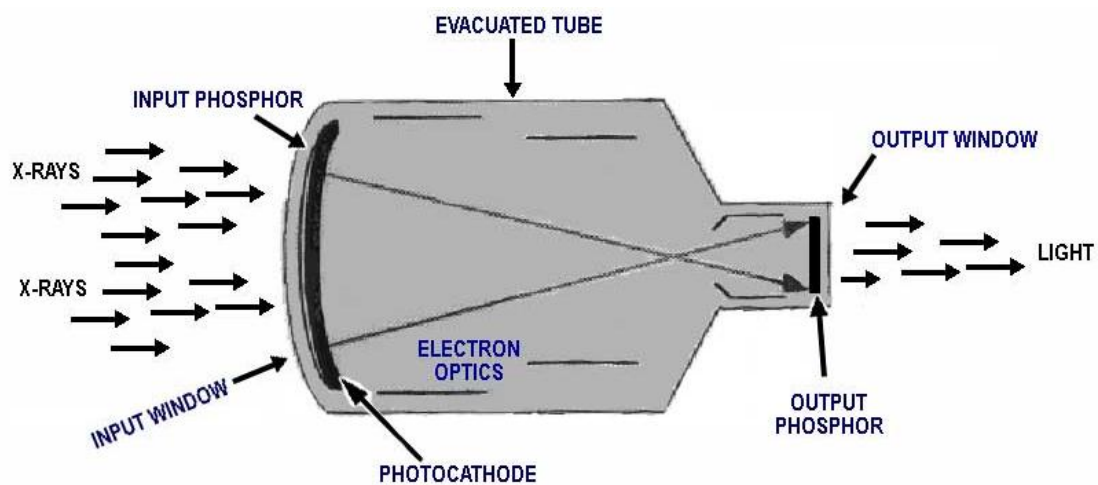

**Figure 3.11 Image Intensifiers (Fluoroscopy)**

## X-Rays Incident

X-rays incident on the i/p fluorescent screen which converts x-ray photon into light photons which are in turn falling on photocathode surface. The emitted photoelectrons are accelerated and focused on a small o/p fluorescent screen. The amplified image passes through the collimating optical system and then to video camera combined with a television system. Thus one can see the image on monitor with proper brightness and contrast. This fluoroscopic image can be recorded on a video disc for a detailed examination performed later and to reduce the patient dose.

## BLOOD FLOW MEASUREMENTS

### CT – General Instrumentation

The timing, anode voltage (kV) and beam cur (mA) are controlled by a computer through a control. The high voltage DC power supply drives a X-ray tube that can be mechanically rotated along the circumference of a gantry. The patient is lying in a table through the centre of the gantry. The x-ray photons impinge several of as many as 1000 radiation detectors fix around the circumference of the gantry. The detector response is directly related to number of photons impinging on it and so to tissue density since a greater proportion of x-rays pass through dense tissues are absorbed than that are absorbed by the less dense tissues. When they strike the detector, the x-rays photo are converted to scintillations. The computer senses the position of the x-ray tube and samples the output of the detector along diameter line opposite to the x-ray tube. A calculation based on data obtained from complete scan is made by the computer. The output unit then produces a visual image of a transverse plane cross section of the patient on the cathodes ray tube. It can also be photographed with a camera to produce a hard copy record. The present day CT machines can obtain slices in 1-2 seconds in high resolution and 5 to 10 seconds in precise mode.

**Electromagnetic Blood Flow Meters** are based on the principle of Faraday's law of electromagnetic induction. A permanent magnet or electromagnet positioned around the blood vessel generates a magnetic field perpendicular to the direction of the blood flow. The voltage induced in the moving blood column is measured with stationary electrodes located on opposite sides of the blood vessel and perpendicular to the direction of the magnetic field.

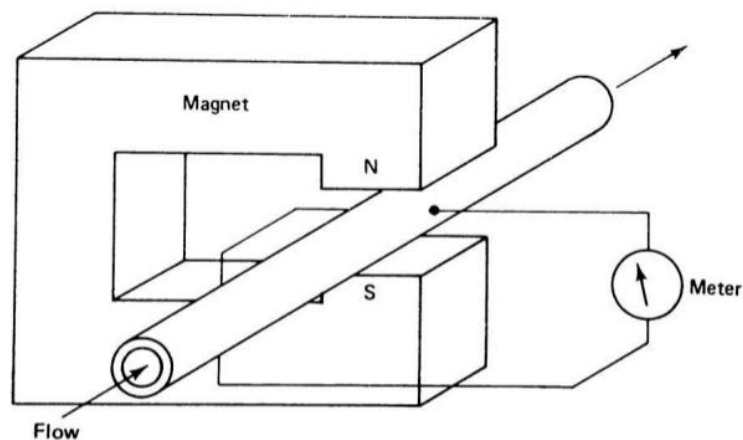

**Figure 3.12 Electromagnetic Blood Flow Meters**

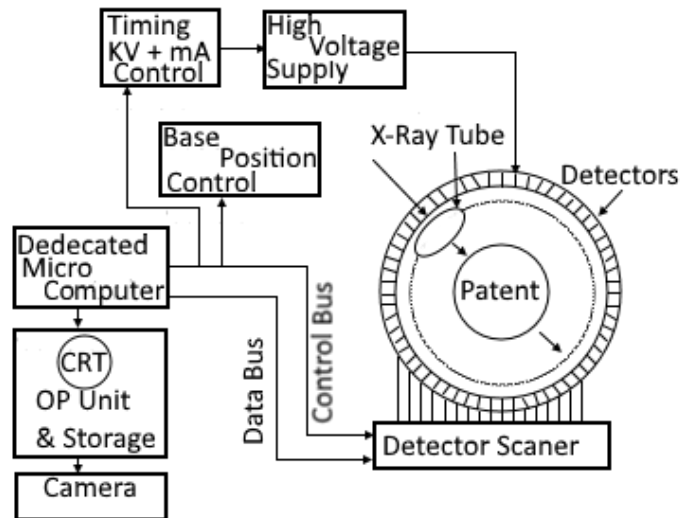

Figure 3.13

## CT – SCANNING SYSEM

The scanning system acquires x-ray transmitted information for an image to be reconstructed. It includes x-ray source and detectors. X-ray transmitted information are of four kinds namely (1) **Position information:** Information on which traverse is being performed and now for is the scanning frame along its traverse. (2) **Absorption information:** Information on values of attenuation coefficient. (3) **Reference information:** information from reference detectors. (4) **Calibration information:** obtained at the end of each transversa.

These information are acquired and taken in the form of profiles. The different scanning gantry commercially used can be categorized as five generations.

### 1. FIRST GENERATION – PARALLEL BEAM GEOMETRY

In this, collimated x-ray beam passes through the body and its attenuation is detected by a sensor from the opposite side. The x-ray tube moves translationally along the patient body length with the sensor on the other side also moving translationally. After a full translational motion the x-ray tube and the detector both make a  $1^\circ$  tilt for the next now linear scan. Thus the x-ray tube and detector scans the patient 180 times around the patient to collect x-ray transmitted information. This set up is called the transvers and index arrangement. The disadvantage of this system is that the scan time is move.

### 2. SECOND GENERATION

The index angle in this system is greater ( $10^\circ$ ). Therefore for each  $1^\circ$  tilt, it is possible to take 10 profiles thus covering the full set of 180 profiles in 18 traverses. The scan time in this method is reduced. The full scanning time is the 18-20s range.

### 3. THIRD GENERATION

The x-ray to be exposed on the patient is a fan beam which is large enough to cover the whole patient. There are multiple detectors system along with the x-ray tube which detects x-ray transmitted information from the patient. The fan beam angle is usually between  $30^\circ$  and  $50^\circ$ . The complete rotation gets over in a few seconds. The disadvantage of this system is that

it cannot change geometry and thus a fan beam set for the largest patient is inefficient for smaller objects.

#### 4. FOURTH GENERATION

Do not have rotating detector. The x-ray tube rotates around the patient exposing x-ray beam and the x-ray transmitted information from the patient is received by detectors surrounding the patient. There are as many as 2000 detectors.

#### 5. FIFTH GENERATION

There are two types

##### **Electron Beam Traverse**

In this both x-ray tube and x-ray detectors are stationary. The electron beam from an electron gun is made to strike on a tungsten array arranged semi circularly underneath the patient. By this x-rays is produced and focused on the patient and the scanning time for a slice is of the order of 50 ms. Silicon photo diodes combined with luminescent crystals are used as detectors. The x-ray transmitted information from the patient is received by detectors arranged in a semicircular fashion above the patient.

##### **Spiral Scanning**

X-ray tube rotates continuously around the patient. In this method fast multiple scans for 3D imaging is possible. Images are reconstructed at secondary positions. By this even a smaller size lesion is not missed.

**Disadvantages:** Since the patient is moved there is blurring of images.

##### **Image Reconstruction**

Data relating to positional information, absorptional information, reference information and calibration information obtained from detector scanners at the gantry are processed by suitable algorithms for reconstruction of images. There are many reconstruction methods variable, 3 are commonly used.

1. Back projection – more like graphical reconstructed.
2. Iterative method – Algebraic solutions.
3. Analytical methods – usage of formula Fourier transform, fast Fourier transform.

In **back projection** reconstruction technique the measured profiles having data from x-ray transmitted information are projected back over the image area at the same angle from which it is taken. The **iterative method** succeeded the back projection method and improvised the image quality by modifying the original profile into a set of profile which can be projected back to a clear image.

##### **Visible Part**

The final picture of the CT is viewed on a television type picture tube. The picture is actually constructed of a number of elements in a square matrix where each elements is the absorption value of the point in the body it represents.

## Storing Part

CT pictures are stored for further processing and evaluation. CT pictures can be stored in magnetic disc, magnetic tape and floppy disc.

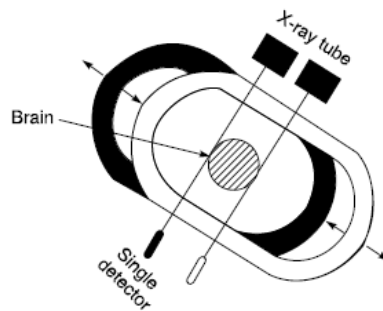

Figure 3.14

## Power Supply

When power is applied, the  $3\text{-}\mu\text{F}$  capacitor is charged through the  $1\text{m}\Omega$  resistor and reaches a voltage that forward biases the base-emitter junction of transistor  $Q_1$  and  $Q_1$  is thus turned ON. This results in a collector current passing through the transformer primary and an emitter current flowing through the  $10\text{ k}\Omega$  emitter resistance. The collector current in  $Q_1$  causes current to be induced in the secondary of the transformer that discharges the capacitor and turns off  $Q_1$ . The process then repeats itself to produce a pulse train. The o/p circuit which amplifies the electrical pulse consists of a transistor operated as a switch and an appropriate coupling ckt to the electrodes,  $Q_2$  operates as an inverter and is coupled to the electrodes through a  $5\text{ }\mu\text{F}$  coupling capacitor. The asynchronous pacemaker, produces pulses at a fixed rate between 70 to 90 beats per minute, their width ranges from 0.5 to 2 ms and amplitude from 5 to 9 volts. **Lead wires:** are interwound helical coils of spring wire alloy moulded in a silicon rubber cylinder.

## Electrodes

The electrodes must withstand flexing due to the pumping action of the heart and must be able to still remain in place. Platinum which is chemically inert, is used for pacemaker electrodes. Charging is done due to the induction of the voltage from the external coil to the internal coil. The induced voltage is rectified, filtered and fed to a voltage regulator so that a constant voltage is provided to the implanted pacemaker even when the patient moves.

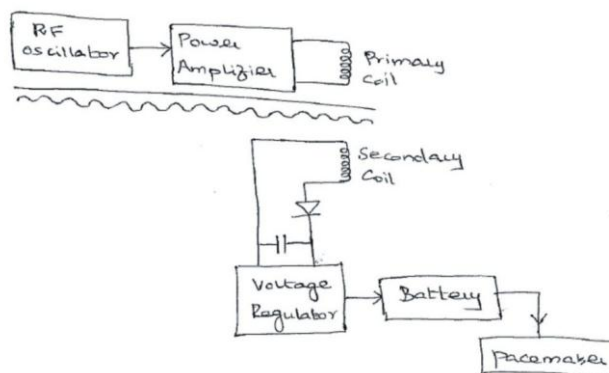
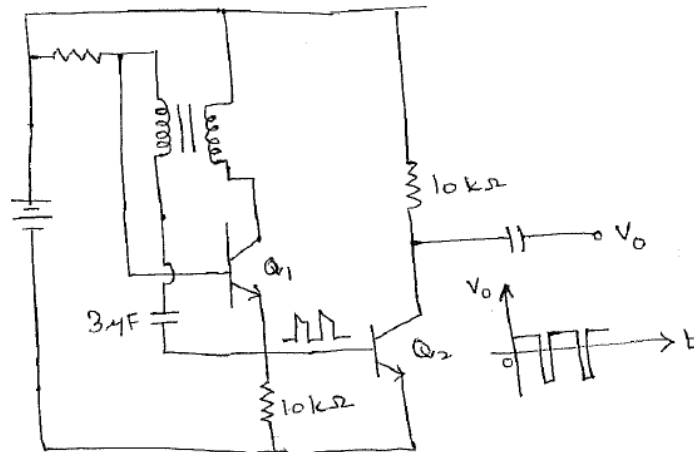

Figure 3.15 Electrodes

## Oscillator

The oscillator provides stimulus pulses at constant rate. A free running blocking oscillator or a multivibrator is common used.



**Figure 3.16 Oscillator**

These are welded to special lead wire alloys to avoid lead wire leakage. Cardiac pacemaker use either unipolar or bipolar type of electrode placement. In unipolar system, one electrode is in contact with the heart to which negative going pulses are connected from the oscillator  $S_1$  a large indifferent electrode is located elsewhere in the body. In **bipolar technique**: two electrodes are placed on the heart and the stimulus is applied across these electrodes. The electrodes are either placed on the external surfaces of the heart, buried within the heart wall or pressed against inside surface of the heart.

## 2. Ventricular Synchronous Pacemaker

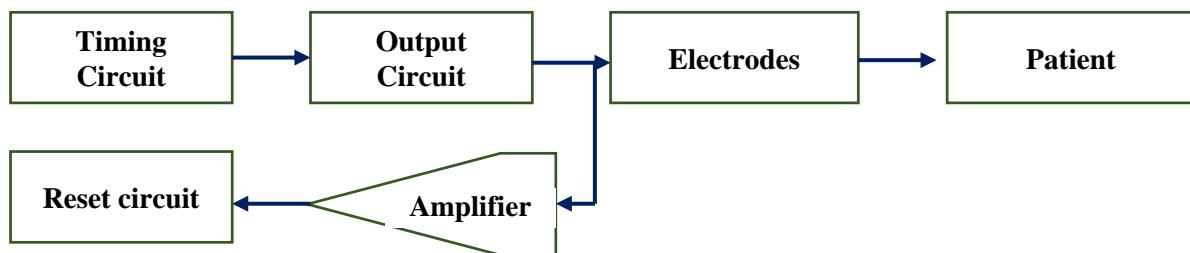

**Figure 3.17 Ventricular Synchronous Pacemaker**

This type of pacemaker is used on patients with only short periods of AV block or bundle block. It consists of a single transverse electrode placed in the right ventricle which senses the R wave and also delivers the stimulation pulses. Immediately after sensing the R wave from an atrial generated ventricular contraction, this pacemaker provides an impulse falling in the lower part of the normal QRS complex. Pulses are provided only when the atrial generated ventricular contractions are absent. If a natural contraction occurs, the pacemaker timing circuit is reset such that it will time its next pulse to detect heart beat. This synchronous pacemaker emits an impulse with the occurrence of each sensed R. wave.

### 3. Ventricular Inhibited pacemaker

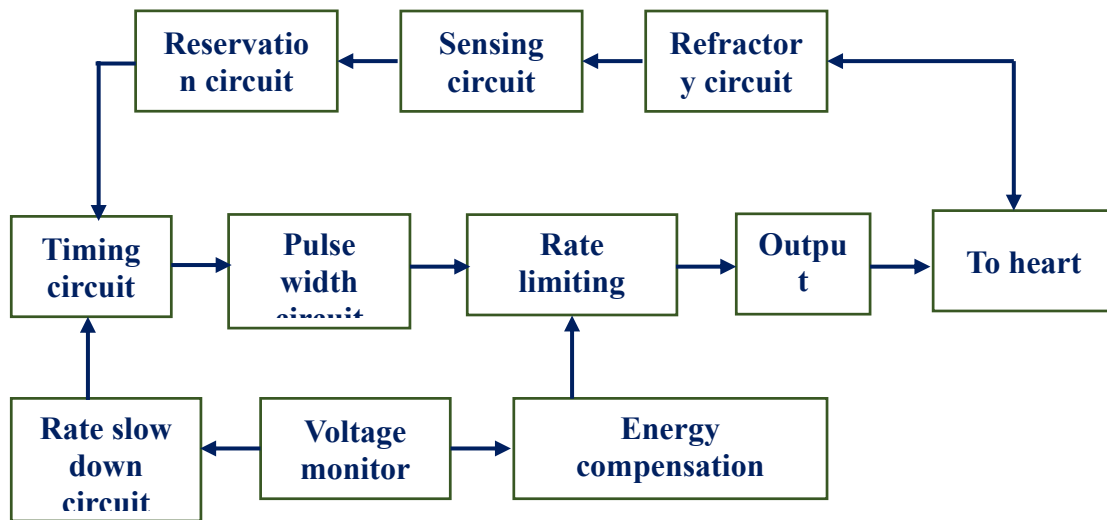

**Figure 3.18 Ventricular Inhibited pacemaker**

This is similar to ventricular synchronous pacemaker. This also senses the presence or absence of a naturally occurring R wave. In this type of pacemaker the output is suppressed as long as the natural R waves are present. In the absence of the R wave it allows the oscillator in the timing circuit to deliver pulses at a present rate. The output of the timing circuit is fed into pulse width circuit which is a RC network. The pulse width circuit determines the duration of the pulse delivered to the heart. Then the o/p of pulse width circuit is fed into rate limiting circuit which limits the pacing rate to a maximum of 120 pulses per minute. The output circuit provides a proper pulse to stimulate the heart. The voltage monitor circuit senses the cell depletion and signals the rate slow down circuit and energy compensation circuit. The energy compensation CKT produces an increase in the pulse duration as the battery voltage decreases to maintain constant. **Stimulation energy to heart.** This type of pacemaker is also called a demand pacemaker.

### 4. Atrial Synchronous pacemaker

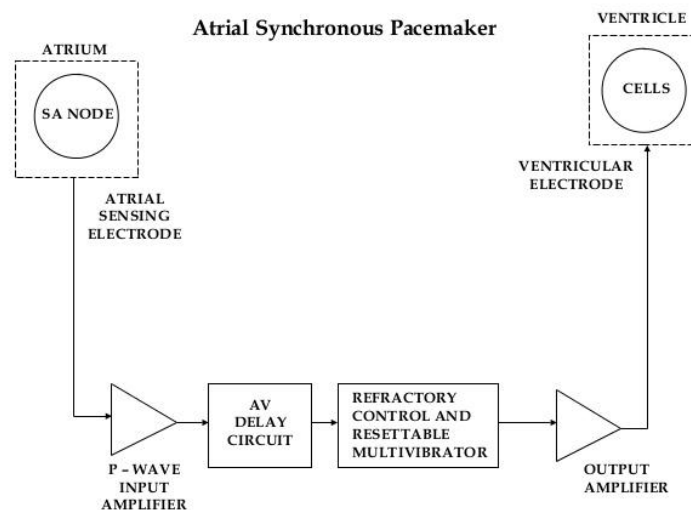

**Figure 3.19 Atrial Synchronous pacemaker**



This type of pacemaker can be used to terminate atrial flutter. It can act as a temporary pacemaker for the atrial fibrillation. The atrial activity is picked up by a sensing electrode placed in a tissue close to dorsal wall of the atrium. The detected wave is amplified and a delay of 0.12 second is provided by the AV delay circuit. The signal is then used to trigger the resettable multivibrator whose o/p is given to the amplifier which produces the desired stimulus to be amplified to the heart. Then the stimulus is delivered to the ventricles through the ventricular electrode. If the rate of atrial excitation becomes too fast as in atrial fibrillation nor too slow or absent a present fixed rate pacemaker takes over until the abnormal situation is over.

## **5. Atrial sequential ventricular inhibited pacemaker**

This has the capability of stimulating both the atria and ventricles. If atrial function fails, this pacemaker will stimulate the atrium and then sense the subsequent ventricular beat. If it is working properly it will discontinue its ventricular stimulating function. If the atrial is not conducted to the ventricle, the pacemaker on sensing this will trigger the ventricle at a present interval of 0.12 seconds.

## **DEFIBRILLATORS**

The heart is able to perform its pumping action only through the synchronized action of the heart-muscles fibres. Cardiac fibrillation is a condition where this synchronism is lost, the individual myocardial cells, contract aschronously and in a rapid irregular cardiac rhythm. This condition is one of most serious medical emergencies and this condition reduces the cardiac o/p to near zero. The fibrillation of atrial muscles is called atrial fibrillation and that of ventricles is called ventricular fibrillation. Defibrillation is the method of reversing the situation or bringing back fibrillation condition to normal. Devices used for this are called defibrillators. Defibrillation is the application of electric shock to the area of the heart which makes all heart muscle fibres enter their refractory period together, after which normal heart action may resume. Sudden cardiac arrest can be treated using a defibrillator and 80% of patients will be cured from the cardiac arrest if the treatment is given within one minute of the attack.

### **Different types of defibrillators**

There are 2 types of defibrillators based on the electrodes placement (i) Internal defibrillator (ii) External defibrillator.

#### **(i) Internal defibrillator**

Used when the chest is opened. Here large spoon shaped electrodes with insulated handle are used. In case of d.c defibrillator, the magnitude of the shock voltage is in the range of 50 v to 1000 v since the electrodes are direct contact with heart, the contact impedance is about 50  $\Omega$ . So that the current passing through the heart is of order of 1 to 20 amperes energy  $\rightarrow$  15 to 50 joules, duration of the shock  $\rightarrow$  is about 2.5 to 5 milliseconds or less.

#### **(ii) External defibrillator**

Used on chest using paddle shaped electrodes. The bottom of the electrode consists of a copper disc with 3 to 5 cm diameter for pediatric patient 8 to 10 cm diameter for adult patient and is attached with highly insulated handle.

<b>Voltage</b>	→ 1000 V to 6000 V
<b>Contact impedance</b>	→ 100 $\Omega$
<b>Energy</b>	→ 50 to 400 joules
<b>Duration of shock</b>	→ 1 to 5 millisecc
<b>Current flowing thro chest</b>	→ 10 to 60 amperes

The electrode is placed in anterior-anterior position one paddle is placed above the apex of the heart and the other is placed on the sternum. Therefore the current flows from the bottom to the top of the heart.

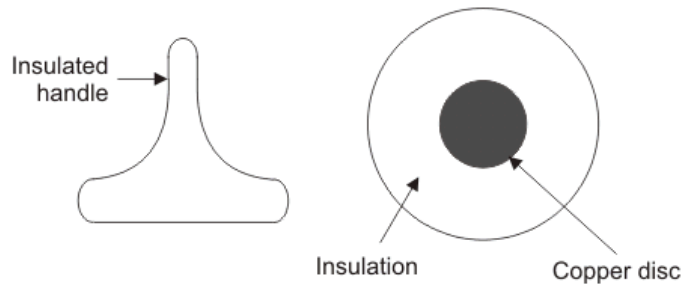
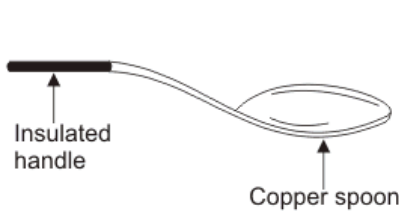
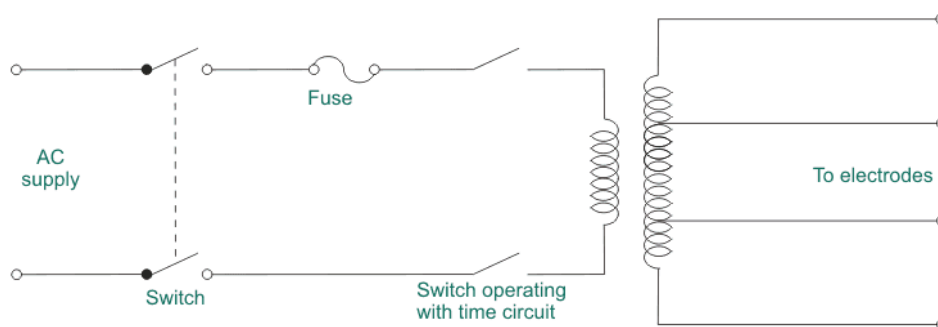

**Figure 3.20(a) Spoon shaped electrode**

**Figure 3.20(b) Paddle shaped electrode**

Depending upon the nature of the voltage applied, the defibrillators can be divided into six types,

- a) A.C defibrillator
- b) D.C defibrillator
- c) Synchronised defibrillator
- d) Square pulse defibrillator
- e) Double square pulse defibrillator
- f) Biphasic D.C defibrillator



**Figure 3.21 AC Defibrillator**

### A.C. DEFIBRILATOR

It is earliest and simplest type of defibrillator. It consists of a step-up transformer with various tappings on the secondary side. An electronic timer ckt is connected to the primary of the transformer. This timer connects the o/p to the electrodes for a pre-set time. The timing device may be a simple capacitor and resistor network or a monostable multivibrator ckt which is triggered by a foot switch or push button switch. The duration of the counter shock may vary from 0.1 second to 1 second depending upon the voltage to be applied. For reasons of safety,

the secondary cell of the transformer should be isolated from earth so that there is no shock risk to anyone touching an earthed object.

- For external def → voltage → 250 v to 750 v
- For internal def → voltages → 60 v to 250 v.

Large currents are required in external defibrillation to produce uniform and simultaneous contraction of the heart muscle fibers. This current not only causes a violent contraction to thoracic muscle, but also results in occasional burning of the skin under the electrodes. Further it produces atrium fibrillation while arresting the ventricular fibrillation.

**b) D.C. Defibrillator**

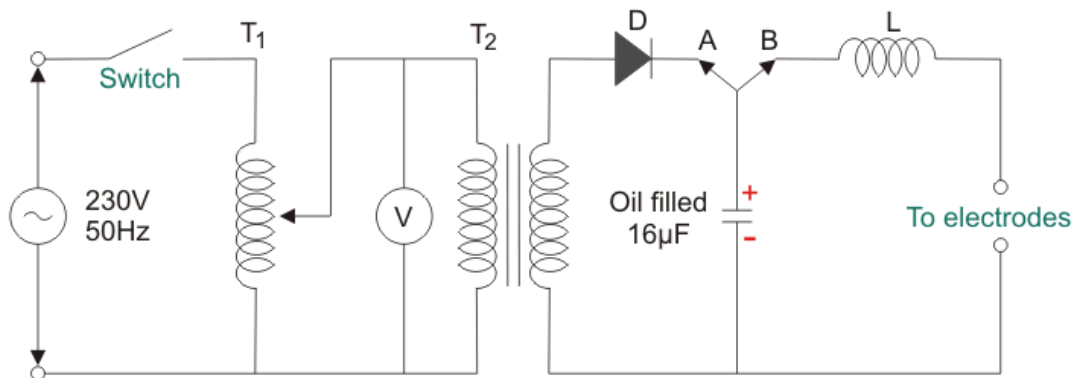

**Figure 3.22 D.C. Defibrillator**

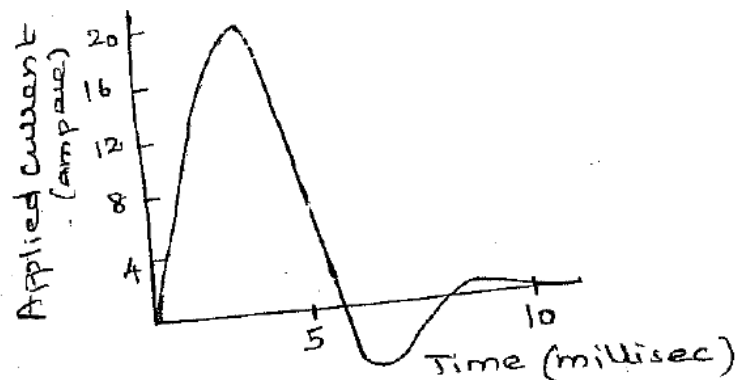

**Figure 3.23**

The d.c defibrillator would not produce undesirable side effects and at the same time, it produces normal heart beat effectively. Here the ventricular fibrillation is terminated by passing a high energy shock, through discharging a capacitor to the exposed heart or to the chest of the patient.

**D.C Defibrillator Circuit**

A variable auto transformer T<sub>1</sub> forms the primary of a high voltage transformer T<sub>2</sub>. In position A<sub>1</sub> that switch is connected to one end of an oil filled capacitor having capacity of 16µF. In this position the capacitor charges to a voltage, set by the positioning of the auto transformer. During the delivery of shock to the patient, a foot switch or a push button switch

mounted on the handle of the electrode is operated, so that the high voltage switch changes over to position B and the capacitor to discharged across the heart through the electrodes. An inductor 'L' is placed in one of the electrode leads so that the discharge from the capacitor is slowed down by the induced counter voltage.

The shape of the waveform that appears across the electrodes will depend upon the value of capacitor & inductor & its amplitude depends on the discharge resistance of 50 to 100  $\Omega$  approximately. The success of defibrillation depends upon the energy stored in the capacitor. Both for external & internal defibrillation 0 – 400 joules of energy is sufficient. Thus if  $c= 16 \mu\text{F}$  & voltage used is 6000 V then energy stored in the capacitor,  $E = \frac{1}{2} C v^2 = \frac{1}{2} \times 16 \times 10^{-6} = 288 \text{ joules}$  The discharging duration is in the range of 5 milliseconds to 10 milliseconds. The passage of high current may damage the myocardium & chest wall. The passage of high current may damage the myocardium and chest wall. To reduce this risk, some defibrillators produce dual peak waveform. This keep the stimulus at peak voltage for longer duration. Same energy can be applied to the heart with low current level. Such defibrillators are called dual peak defibrillators or delay line capacitive discharge d.c. defibrillators.

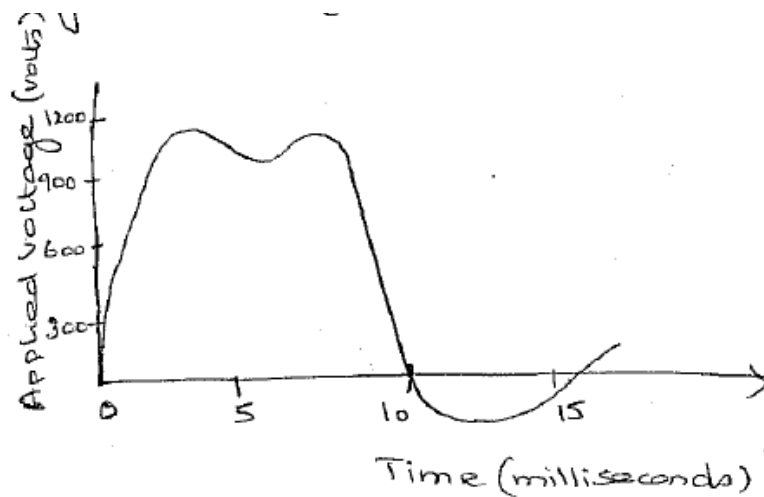

**Figure 3.24 o/p of dual peak d.c. defibrillator**



**SATHYABAMA**

INSTITUTE OF SCIENCE AND TECHNOLOGY  
(DEEMED TO BE UNIVERSITY)

Accredited "A" Grade by NAAC | 12B Status by UGC | Approved by AICTE

[www.sathyabama.ac.in](http://www.sathyabama.ac.in)

**SCHOOL OF ELECTRICAL AND ELECTRONICS**

**DEPARTMENT OF ELECTRICAL AND ELECTRONICS**

**UNIT – IV - Biomedical Instrumentation – SIC1311**

## BIOMEDICAL MEASUREMENT

### The pH Electrode – pH Measurement

The chemical balance of the body is identified by the measurement of pH of blood and other body fluids. The pH is defined as the logarithm of the reciprocal of the  $H^+$  ion concentration.

$$(ie) \text{ pH} = \log_{10} \frac{1}{[H^+]} = -\log_{10} [H^+]$$

For pH measurement silver-silver chloride electrode is used as the measuring electrode. It can be called the glass electrode, which consists of a glass tube with a spherical bulb at the bottom. The bulb is of 0.5 cm in diameter. The bulb provides a thin glass membrane which permits the passage of only hydrogen ions in the form of  $H_3O^+$ . This glass bulb has the Ag / AgCl electrode immersed in chloride buffer solution. Using KCL in 0.1M HCL is used. This glass electrode which is the measuring electrode is kept in the solution of unknown pH. A calomel reference electrode is used. The calomel electrode is made of a glass inner tube fixed with mercurous chloride ( $Hg_2Cl_2$ ) paste. This glass tube has a porous plug at the bottom. A platinum wire is inserted through this, which is a lead wire. On top of the  $Hg_2Cl_2$  paste an elemental mercury layer is formed. This whole glass set up is now placed in an outer bigger glass tube with the porous plug at the bottom. The outer glass tube is filled with KCL forms a half cell potential.

The porous plug at the bottom of the electrode assembly is used to make contact between the internal KCL electrolyte and the unknown pH test solution into which the electrode is immersed. The potential between this electrode and the glass measurement electrode gives the pH of the unknown solution. Since a salt bridge is formed between the KCL in measuring electrode (unknown test solution) and KCL in reference electrode. This type of electrodes can be used in coloured, turbid solutions. Nowadays this electrode comes as combination electrodes in which both reference electrode and measuring electrode is in a single set up.

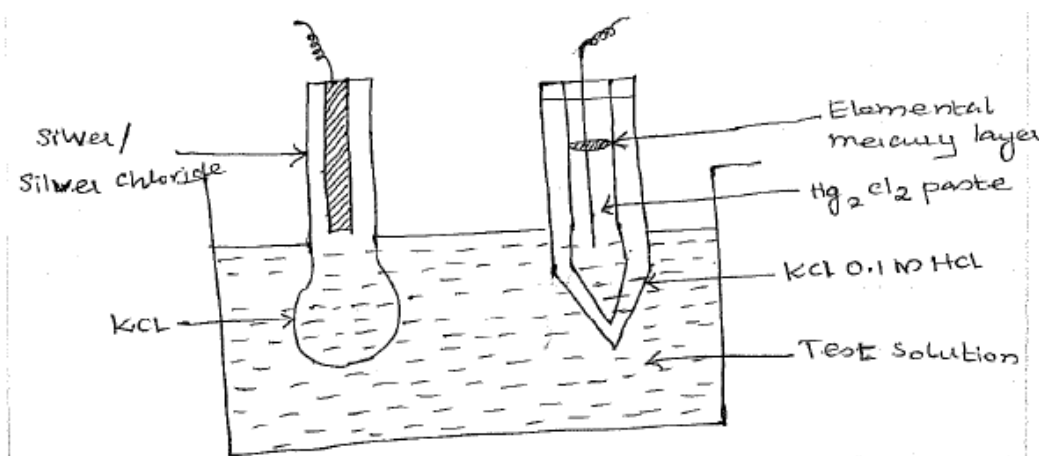
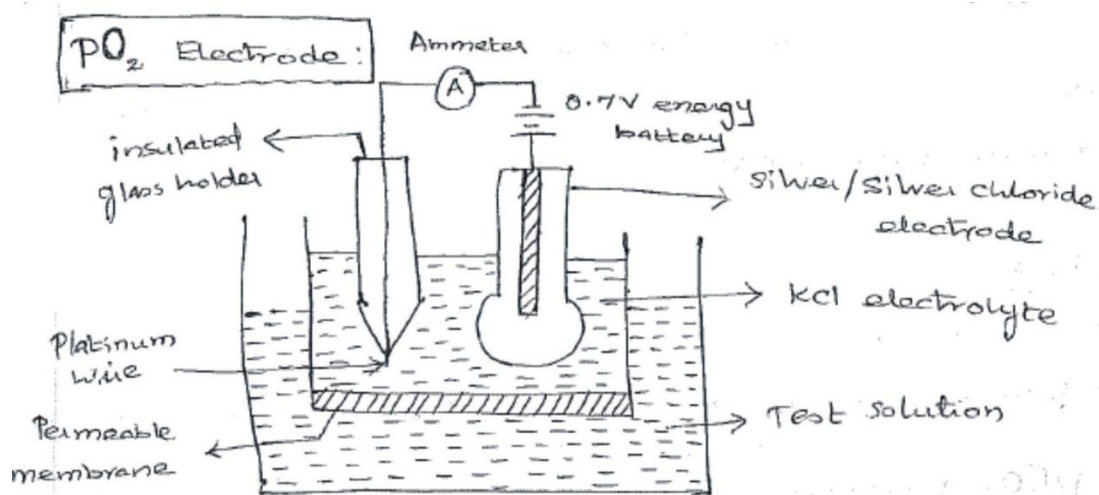

Figure 4.1 pH Electrode



**Figure 4.2 PO Electrode**

Oxygen electrode consists of platinum wire embedded in an insulating glass holder with the end of the wire exposed to the electrolyte. This is used as the measuring electrode. Ag / AgCl reference electrode is used. KCl electrolyte is used. The bottom of the vessel containing electrolyte consists of a membrane permeable to oxygen and the top of the vessel is sealed. A voltage of 0.7 volts is applied between the platinum wire and the reference electrode using a battery. The negative of the battery is connected to the platinum wire through an ammeter. Reduction of oxygen takes place at the platinum wire. Due to that, oxidation-reduction current is developed which is proportional to the partial pressure of the diffused oxygen.

The vessel containing the electrolyte and the electrodes with the permeable membrane at the bottom is kept in the vessel containing unknown test solution. Oxygen from the test solution diffuses through the permeable membrane and contributes to oxidation reduction current. Thus partial pressure and hence the concentration of the oxygen in the test solution is found out. The permeable membrane can be anything from cellophane, polythene, silicane, rubber etc.

### **PCO<sub>2</sub> ELECTRODE**

PCO<sub>2</sub> electrode consists of the standard glass electrode used as pH measurement electrode. It is enclosed by a permeable rubber membrane. A thin film of water surrounds the glass electrode in between the rubber membrane. The whole set up is kept in the solution whose CO<sub>2</sub> concentration is to be found out. CO<sub>2</sub> from the solution diffuses through the rubber membrane and reaches the water film. The pH of the water film which is measured with the help of the silver / silver chloride electrode gets disturbed and changes depending on the diffused CO<sub>2</sub>. Thus concentration of CO<sub>2</sub> is measured.

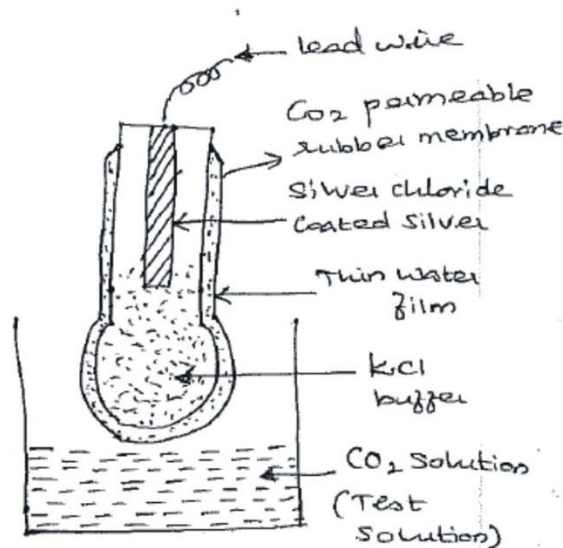

**Figure 4.3 PCO<sub>2</sub> ELECTRODE**

The electromagnetic flow meter is a device used for measuring pulsatile blood flow. The fundamental quantity measured by these flow meters is blood velocity. It is suitable for determining the instantaneous flow rates in intact vessels. Continuous measurement of blood velocity can be obtained by placing the electromagnetic flow probe around arteries and veins. The resulting velocity can be correlated with blood flow. The induced voltage is picked up by 2 electrodes incorporated with the electromagnetic assembly.

The magnitude of the voltage is proportional to the strength of magnetic field, diameter of blood vessel and velocity of blood flow.

$$E = CHVD \quad (1)$$

- E - Induced voltage
- C - Proportionality constant
- H - Magnetic field strength
- V - Velocity of blood flow
- D - Diameter of blood vessels

Where  $C_1 = CHD$  all are constant

$$E = C_1V \quad (2)$$

$$\text{Flow rate } Q = VA \quad (3)$$

$$V = Q/A \quad (4)$$

A - Area of cross section of the tube (4) in (2)  
 $E = C_1 Q/A$  since area of cross section is constant  
 $E = C_2Q \therefore C_2 = C_1 / A$

Thus flow rate is proportional to the induced voltage. The induced voltage is picked up by the electrodes and then amplified and divided. This fluoroscopic image can be recorded on a video disc for a detailed examination performed later and to reduce the patient dose.



## OXIMETERS

Oximeters are used to determine the percentage of oxygen saturation of the circulating arterial blood.

$$\text{Oxygen saturation} = \frac{[\text{HbO}_2]}{[\text{HbO}_2] + [\text{Hb}]}$$

Where,

[HbO<sub>2</sub>] – Concentration of oxygenated hemoglobin

[Hb] – Concentration of deoxygenated hemoglobin

The measurement of oxygen saturation is mainly used in the diagnosis of cardio respiratory functions. It is known that blood consists of red blood cells (RBC) with density 4.26 – 6.2 millions / μl and size 6.8 – 7.5 μm, white blood cells (WBC) with density 0.004 – 0.011 millions / μl and size 6 – 18 μm. Platelets (PLT) with density 0.15 – 0.40 millions / μl and size 2.4 μm in liquid plasma. In plasma, the oxygen is dissolved about 0.35 and therefore the plasma is a very poor carrier of oxygen. Actually the oxygen is carried red blood through haemoglobin. Haemoglobin in the RBC combines with oxygen and forms a compound called oxyhemoglobin.

The amount of oxygen combining with hemoglobin depends upon the partial pressure of oxygen. Oximetry is dividend in 2 types

1. Vitro oximetry
2. Vivo oximetry

### 1. VITRO OXIMERY

The blood is taken out and measurement for oxygen saturation is made at a later time in the laboratory. The oxygen saturation is determined spectrophotometrically by transmission mtd or reflection mtd. Generally the total hemoglobin varies with the individual and changes in time with a periodicity determined by cardiac function. To eliminate the errors arising from the variation of the concentration of hemoglobin, the measurement are made at 2 different wave lengths, one at 650 nm where the transmission of light through the oxygenated blood is maximum (or) the reflection is minimum and at 805 nm where the transmission of light through oxygenated or oxygen reduced blood are the same.

In the transmission oximetry, the intensity of the transmitted light is measured using lambert – beer law.

$$I = I_0 \& -\mu l$$

I → transmitted monochromatic light intensity

I<sub>0</sub> → incident monochromatic light intensity

L → thickness of the substance (or) path length of the light transmitted.

A portion of the light scattered by the sample at a given angle is collected by a 2 photoconductive cells, P<sub>1</sub> and P<sub>2</sub> separately as shown in figure. Two interference filters F and F' are used to pass the light corresponding to wavelengths 650 nm and 05 nm respectively. The ratio of the resistance of the photoconductive cells is measured using a bridge circuit and the reciprocal of this ratio value gives the ratio of the light intensities scattered by the sample at the respective wavelengths.

## 2. VIVO OXIMERY

Transmission – finger tip oximeter and Reflection – hemoreflector are used to measure oxygen saturation. Vivo oximetry can be carried out at sites like ear lobe or finger tip. Nowadays using optical fibres direct oxygen saturation can be measured by inserting the catheter consisting transmitting – receiving optical fibres into the blood vessel. Figure shows block diagram of a finger tip oximeter. Yoshiya developed thin non-invasive oximeter that determines the oxygen saturation of arterial blood in the fingertip. By determining ‘ $\mu$ ’ the oxygen saturation can be determined in a given hemolysed blood sample. In reflection oxymetry, the oxygen saturation can be calculated by measuring the intensity of the scattered light by the unhemolysed blood.

$$\text{Oxygen saturation} = a - b \frac{I(805 \text{ nm})}{I(650 \text{ nm})}$$

where,

- a, b → positive constants
- I (805 nm) → intensity of the scattered light having wavelength 805 nm
- I (650 nm) → intensity of the scattered light having 650 nm

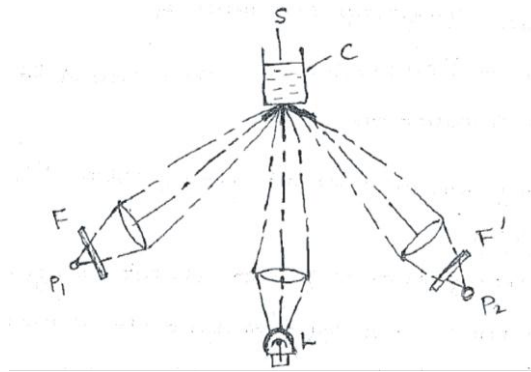

**Figure 4.4 Optical arrangement in reflection oximeter**

Light from a tungsten filament lamp (L) is condensed by a lens and is allowed to incident on the plane bottom of a cylindrical cuvette ‘C’ in which the sample ‘S’ is placed. The light emitted by a halogen lamp is applied to the finger probe using an optical glass fibre. The transmitted light is received by another fiber assembly in which there are two branches. Interference filters are placed in the two branches so that the transmitted signals are obtained at the respective wavelength 650 nm and 805 nm. Photo cells convert the light intensity into electrical voltage. The calculation is done by some logic circuits. Where A & B are constant related to the absorption coefficients of hemoglobin and oxyhemoglobin respectively.

V – absorption coefficient.

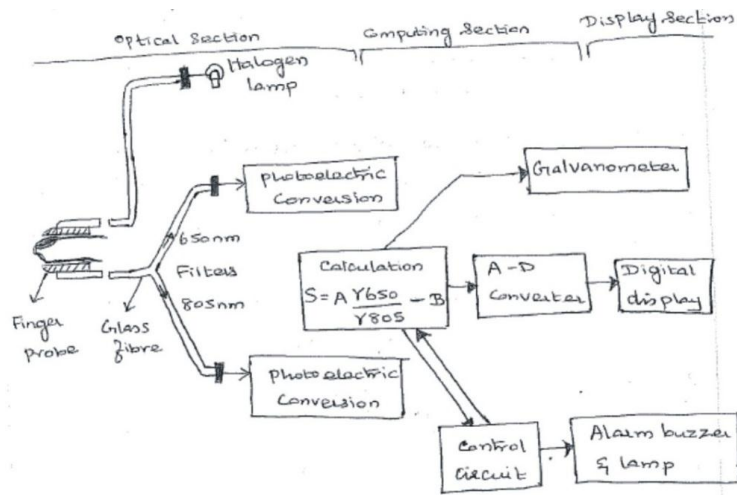

**Figure 4.5**

### Isotopes in Medical Diagnosis

1. Technetium – 99 m → Used to image the skeleton and heart muscle in particular, also for brain, thyroid, lungs etc.
2. Bismuth – 213 → Used for targeted alpha therapy (TAT) especially cancers.
3. Erbium – 169 → Used for relieving arthritis pain in synovial joints.
4. Holmium – 166 → Being developed for diagnosis and treatment of liver tumours.
5. Copper – 64 → Used to study genetic diseases affecting metabolism.
6. Iodine – 132 → Widely used in treating thyroid cancer and in imaging the thyroid and also in diagnosis of abnormal liver function.
7. Gallium 67 → Used for tumour imaging and localization of infections.
8. Thallium – 201 → Used for diagnosis of coronary artery disease.
9. Rhenium – 188 → Used for pain relief in bone cancer.
10. Xenon – 133 → Used for pulmonary (lung) ventilation studies.

### RESPIRATION RATE MEASUREMENT

The rate at which the rhythmic activity of inhalation and exhalation takes place under normal circumstances is called respiration rate. Different methods to measure respiration rate namely

1. Displacement method
2. Thermistor method
3. Impedance pneumography
4. CO<sub>2</sub> method

### DISPLACEMENT METHOD

As respiration takes place the thorax expands and comes back to normal state. This change in thorax size can be detected to find respiration rate. A displacement transducer with strain gauge element is held around the chest by an elastic band. As thorax size varies there is resistance change in the strain gauge element. The strain gauge element connected to one arm of a wheat stone bridge gives o/p signal proportional to rate of respiration. The change in thoracic size can also be detected by having a rubber tube filled with mercury tied around the chest. During inspiration the chest size increases, hence the rubber tube also increases in size,

and thus resistance of mercury from one end of the tube to the other varies. This variation in resistance is measured by sending a constant current through the mercury and sensing the change in voltage which is proportional to respiration rate.

### Thermistor Method

By keeping a thermistor using suitable holding device near the nostril the difference of temperature between inspired and expired air is sensed. The resistance change in synchronism with the respiration rate corresponding to temperature variation is found out. In case, the difference in temperature of the outside air and expired air is small, the thermistor can be heated initially and then resistance variation measured. The thermistor is placed as a part of a voltage dividing circuit or a bridge circuit whose unbalance signal is amplified to obtain respiratory activity.

### CO<sub>2</sub> Method

Respiration rate can also be measured by monitoring CO<sub>2</sub> expired by the subject. The monitoring of CO<sub>2</sub> is based on absorption property of infrared rays by CO<sub>2</sub>. When the infrared rays are passed through the expired air containing a certain amount of CO<sub>2</sub>, some of the radiation are absorbed by it. Due to this, there is loss by heat energy associated with the rays. To detector gives a corresponding electrical signal proportional to respiration rate. The detection of CO<sub>2</sub> in expired air is made possible by passing 2 beams of equal intensity of infrared radiation on a reference cuvette and also test cuvette separately. The detector has two identical portions separated by a thin, flexible metal diaphragm. The detector is filled with CO<sub>2</sub>. Since CO<sub>2</sub> in the test cell absorbs IR radiations the intensity of IR beam falling on the detector in the test side is weaker than that falling on the reference side. Thus CO<sub>2</sub> in the reference side of the detector is more heated compared to the test side. As a result, the metal diaphragm is pushed slightly to the test side. This diaphragm acts as one plate of the capacitor and thus variation is detected, and then amplified and given to recorder. The CO<sub>2</sub> measured during each respiration cycle is proportional to respiration rate.

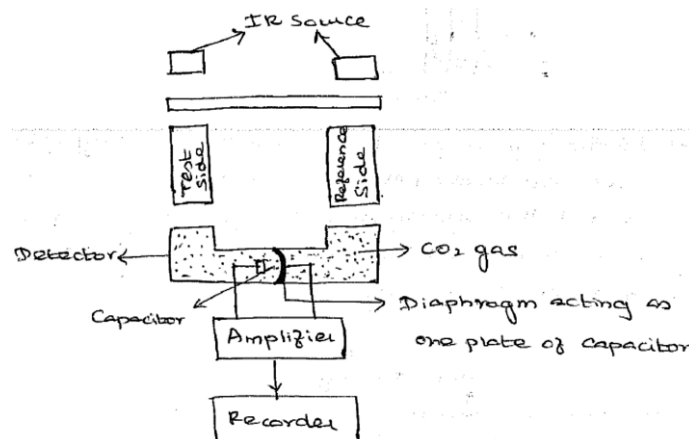

Figure 4.6

## PATIENT MONITORING SYSTEM

### Bedside Patient Monitoring

Patient monitoring system involves continuous measurement and monitoring of physiological parameters like respiratory rate, body temperature, blood pressure and heart rate.

In special cases, additional monitoring of the EEG, ECG, EMG phonocardiogram also measured and monitoring. In PMS, the transducers used must be reliable and simple in construction. The bedside monitors consist of individual units which may be wall or shelf mounted.

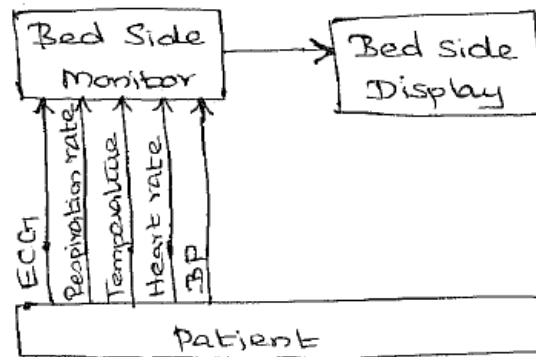

**Figure 4.7**

All the transducers to measure various physiological parameters are located at the region of interest on the patient and the electrically converted physiological signals and transmitted through wires to the bedside monitor where it is displayed as either analog or digital signals. For measuring the respiration rate a thermistor is placed near the nasal opening. When the patient breathes out, the variation of resistance can give an indication of the respiratory rate. For pressure measurement, the strain gauge transducer is used. For pulse rate measurement photoelectric finger pulse monitor is used.

### CENTRAL MONITORING SYSTEM (CMS)

The CMS, the physiological values of patients are measured at bedside and these are displayed and recorded at a central station. The physiological parameters measured at the bedside include → ECG → Respiration rate → Blood pressure → Temperature → Pulse rate → Oxygen saturation in blood etc. The electronics which aid for measurement and the signal conditioners are located at the bedside whereas the display, recorders, alarms etc are located at the central station.

The CMS is built up with many microprocessors which enable the smooth display of waveforms, alphanumeric and graphics on a single CRT. The CMS provides all measured information at a glance. It generates audible and visual alarms if the values measured exceed their present limit. It displays the patients vital sign data. The information (physiological parameters) from patient bedside like blood pressure ECG, heart rate.

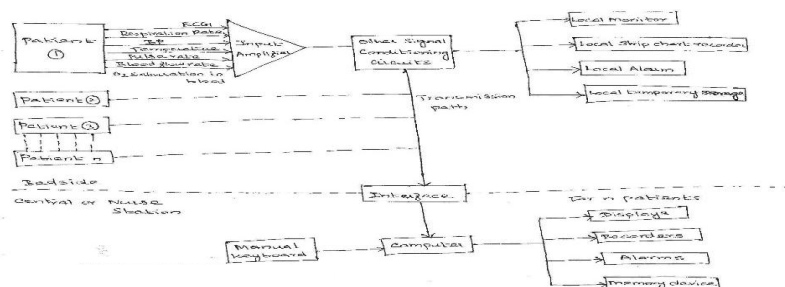

**Figure 4.8 Block Diagram of CMS**



**SATHYABAMA**

INSTITUTE OF SCIENCE AND TECHNOLOGY  
(DEEMED TO BE UNIVERSITY)

Accredited "A" Grade by NAAC | 12B Status by UGC | Approved by AICTE

[www.sathyabama.ac.in](http://www.sathyabama.ac.in)

**SCHOOL OF ELECTRICAL AND ELECTRONICS**

**DEPARTMENT OF ELECTRICAL AND ELECTRONICS**

**UNIT – V - Biomedical Instrumentation – SIC1311**

## LASER APPLIATIONS

In recent years, the number and variety of applications of lasers to medicine have increased rapidly. **LASER** is acronym for Light Amplification by Stimulated Emission of Radiation. Laser beam consists of high intense radiation in unique direction without spreading of its energy in other directions. Laser has high monochromacity and high directionality.

- Highly sterile
- Non contact and bloodless surgery.
- Minimal post operative swelling, scarring and pain.
- Short-duration surgery
- No harmful radiations.

## LASER INSTRUMENTATION

Laser irradiation of patients with skin tumors is performed in a specially designed operating unit which consists of three separate sections. In first section, a pulsed NCl – YAG Laser (with pulse energy more than  $10^6$ W) and a continuous wave CO<sub>2</sub> Laser (50 W) and continuous wave Argonion Laser (4W) are installed. The Laser irradiation is transmitted by a suitable optical fiber light guide system to the scanning device in the second section. It also contains necessary operation theatre equipment and remote controlled scanning device. The third section is intended for remote control circuit. The operation can be observed by means of a television arrangement. A radio communication is also maintained between the biomedical engineer who is incharge of Lasers and the surgeon in the operating theatre. The Lasers are equipped with a water cooling system. The apparatus includes a vacuum trap for smoke and dust particles and a device for focusing the radiation and aiming it on the target. A low power He-Ne Laser o/p is used as a guiding beam so as to locate the spot correctly.

The energy of the radiation is indicated by the energy meter and irradiation time is controlled properly by a timer. The rooms are equipped with warning signal circuits and a blocking system that prevents the laser system from working unless the doors of that room are closed. By pressing the foot switch after locating the point where the irradiation to be given a preset dosage of pulsed radiation is emitted from the laser at the target. During laser surgery the patient and the surgeon should wear protective goggles to protect the eyes. The pulsed radiation of the Nd-YAG laser and CWCO<sub>2</sub> laser are used for the destruction of tumors by coagulation.

### Advantages of Laser Surgery

(1) Highly sterile (2) Non context surgery (3) Dry field, almost bloodless surgery (4) Clear field of view and easy access in confined areas. (5) Short periods of surgical time. (6) Prompt healing with minimal swelling and scaring. (7) No electromagnetic interference on monitoring instruments.

### Photothermal Applications

Laser heating of tissue is used for two distinct surgical functions, cutting, as a scalpel and photocoagulation. The first medical application of laser was ophthalmology. Ophthalmologists use them to treat variety of eye problems, including (1) retinal bleeding (2) the excessive growth of blood vessels the eye caused by diabetes (3) “spot welding” – reattaching retinas that have become partly detached from the back surface of the eye, the

chroid. To do the same, surgeons have used the photocoagulation effect (ie) heating the tissue at 60°C to denature the proteins. Argon ion lasers, which emit blue green light is readily absorbed by the blood, are preferred for photocoagulation of small blood vessels in the eye. Nd-YAG Lasers are also used for blood vessel and tissue coagulation. Pulsed Nd-YAG laser that generates very short pulses is greatly used for photocoagulation.

Laser photocoagulation can also be used in dermatological surgery to remove port wine lesions. (Red birth marks), the disfiguring marks caused by excessive development of blood vessels in the skin. Also used to remove tattoos and moles. Laser-photocoagulation used during conventional surgery on such organs like the spleen, the liver and the kidneys, where excessive bleeding is often a problem. In cutting tissues with CO<sub>2</sub> Laser, the laser light is absorbed in a small volume, causing a little damage to surrounding tissues. It is a bloodless and precise one. The flexibility of delivery and the capability for concentrating the laser beam on a small spot are unique advantages over conventional techniques in some surgical operations. eg: The laser is used to treat one of the fallopian tubes, down which fertilized eggs travel to the uterus. The laser light can be directed to the fallopian tubes by an endoscope inserted through an incision in the abdominal wall. A surgeon can use the laser beam to burn out the blockages, after which he constructs the tube.

## ENDOSCOPY

Endoscopy means looking inside and refers to looking inside the human body for medical reasons using an instrument called an endoscope. It is used to assess the interior surfaces of an organ by inserting a tube into the body. The instrument may have flexible tube and it provides an image for visual inspection and photography. An endoscope can consists of (1) A flexible tube. (2) A light delivery system to illuminate the organ or object under inspection. The light source is normally outside the body and the light is typically directed via an optical fiber system. (3) A lens system transmitting the image to the viewer from the fiberscope. (4) An additional channel to allow entry of medical instruments or manipulators.

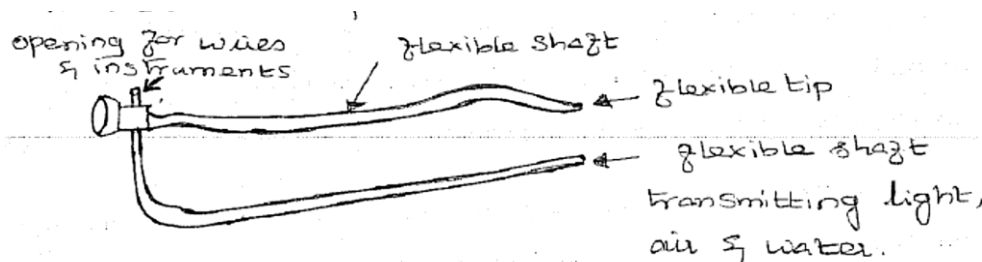

**Figure 5.1 Endoscopy**

The modern endoscope has two light channels to illuminate the area of interest (1) An image channel to enable the doctor to see what's happening (2) An instrument channel through which instruments can be placed. A range of special instruments can be inserted which enables doctors not only to see inside to make an accurate diagnosis, but also operate on the diseased area. This might be to → Cut out diseased tissue → Take a biopsy → Seal a site of bleeding with heat. Remove an object that is causing an obstruction. At the eye piece end, A TV camera, A still camera, A movie camera can also be attached. The endoscope has also enable doctors to carry out key hole surgery where surgical treatments can be applied without having to make major incisions. This lead to less complications and more rapid recovery of the patient. There are many types of endoscope and they are named according to the organs or areas they explore.



Endoscopes used to look directly at the varies, appendix or other abdominal organs for example is called laparoscopes (exam is laparoscopy).

Other endoscopes are inserted through incisions to look at joints (arthroscopy) or the lungs (bronchoscopy) and still others are used to view the inside of the bladder (cystoscopy). The latest development is to have a video camera at the end of the endoscope. Endoscopy can be used to diagnose various conditions by close examination of internal organs and body structures.

**Biopsy** (tissue sampling for pathologic testing) may also be performed under endoscopic guidance. Local or general anesthetic may be used during endoscopy, depending upon the type of procedure being performed. Endoscopy is a minimally invasive procedure and carries with it certain minor risks depending upon the type of procedure being performed. Endoscope procedure does not require hospital admission. Acute care and observation may be performed outside the premises of a hospital. This allows the patient to go home or return to work within a short while after their procedure. Endoscopy can involve the gastro intestinal tract (GT tract)

- Oesophagus, stomach and duodenum
- Small intestine
- Colon
- Bile duct

The urinary track (cystoscopy) The female reproductive system

- The cervix
- The uterus
- The fallopian tubes

During pregnancy

- Fetoscopy

Closed body cavities (through a small incision)

- The abdominal cavity (laparoscopy)
- Organs of the chest (thoracoscopy and mediastinoscopy)

## **ECHOCARDIOGRAPHY**

In the echocardiogram, movements of the valves and other structures of the heart are displayed. Echocardiology has been extremely useful in diagnosing many cardiac abnormalities, pulmonary valve stenosis; mitral valve stenosis and rheumatic heart disease. In selecting a transducer for an echocardiographic investigation, the following factors must be considered.

1. Physical size of the patient
2. The anatomic area involved
3. The type of tissue to be encountered.
4. The depth of the structure.

For this particular echocardiogram the transducer was placed so that the beam crossed the chest wall into the right ventricle, through the septum, into the left ventricle and ultimately through the left atrium. The aorta and mitral valve are also imaged. With ultrasound it is

possible to distinguish between different soft tissues and to measure the motion of structures of the heart. One important factor is that there is virtually no interference by echoes from other body structures, since the heart is surrounded by the lungs, which are literally air bags. This helps in the interpretation. The heart has a number of acoustic interfaces such as the atrial and ventricular walls, the septum and the various valves.

The position and movements of each interface can be measured by the reflected ultrasound. This type of echocardiogram is useful in interpreting the movements of the mitral valve with respect to time. If the mobility is reduced, as in the case of mitral stenosis (narrowing of the left ventricular orifice), its severity compared with other existing conditions can determine the appropriate action to take, including the possible use of surgery. Another use of echocardiography is in the detection of fluids. When the pericardium (the sac surrounding the heart) is inflamed there is sometimes an escape of fluid. The presence of this fluid can be detected in the echocardiogram. Fast scanning speeds are required to prevent blurring of the image due to heart movements. To give a thorough dynamic analysis, many simultaneous recording can be taken in different positions so as to give cross sectional images at various points along the length of the heart.

## MAGNETIC RESONANCE IMAGING (MRI)

### Principle

The human body consists of millions of atoms in which 80% of the atoms are hydrogen atoms. A patient is placed in the external magnetic field which causes the magnetization of protons of hydrogen atoms in the body. Due to magnetization, these protons align themselves in accordance to the external magnetic field and the protons undergoes some precession at a frequency called larmor frequency. The larmor frequency is given by  $\omega_0 = \gamma B_0$ .

where  $\gamma$  - constant called magnetogyric ratio  
 $B_0$  strength of the applied magnetic field

Each hydrogen atom process at its own larmor frequency and hence posses different energies  $E = \hbar\omega$ . At equilibrium lower energy nuclei are more in number compared to higher energy nuclei. Now using reference radiation at resonance with energy equal to the difference in energy of lower state and higher state, all lower energy nuclei are pushed to higher energy level. These excited nuclei will slowly fall back from higher energy level to lower energy level simultaneously giving out reference signals called nuclear magnetic resonance signals. The NMR signals are detected, processed and image is obtained. The NMR signals are picked by RF coils and processed by computers using Fourier transforming techniques to produce an image.

### MRI - INSTRUMENTATION

The basic components of MRI system includes (1) Magnet (2) Co-ordinate system (3) RF transmitter system (5) Imager system. The magnet produces a strong, uniform, steady magnetic field  $B_0$ . The gradient coils produce a time varying non uniform magnetic field and this gradient field is used to obtain spatial distribution information. There are transmitter and receiving RF coils surrounding the site on which the image is to be constructed. There is a super position of a linear magnetic gradient field and the uniform magnetic field applied to the patient. When this super position takes place, the resonance frequencies of the processing

nuclei will depend primarily on the positions along the direction of magnetic field gradient. This produces a one dimensional projection of the structure of the 3D object.

By taking a series of these projections at different gradient orientations using X, Y, Z gradient coils a 2 or 3D image can be obtained. The slice of the image depends on the gradient magnetic field. The gradient magnetic field is controlled by computer and that field can be positioned in three variant planes (X, Y, Z). The transmitted provides the RF signal pulses, the received nuclear magnetic resonance is picked up by the receiver coil and is fed into the receiver for signal processing. By two dimensional Fourier transformation the image is constructed by the computer and is displayed on the television screen.

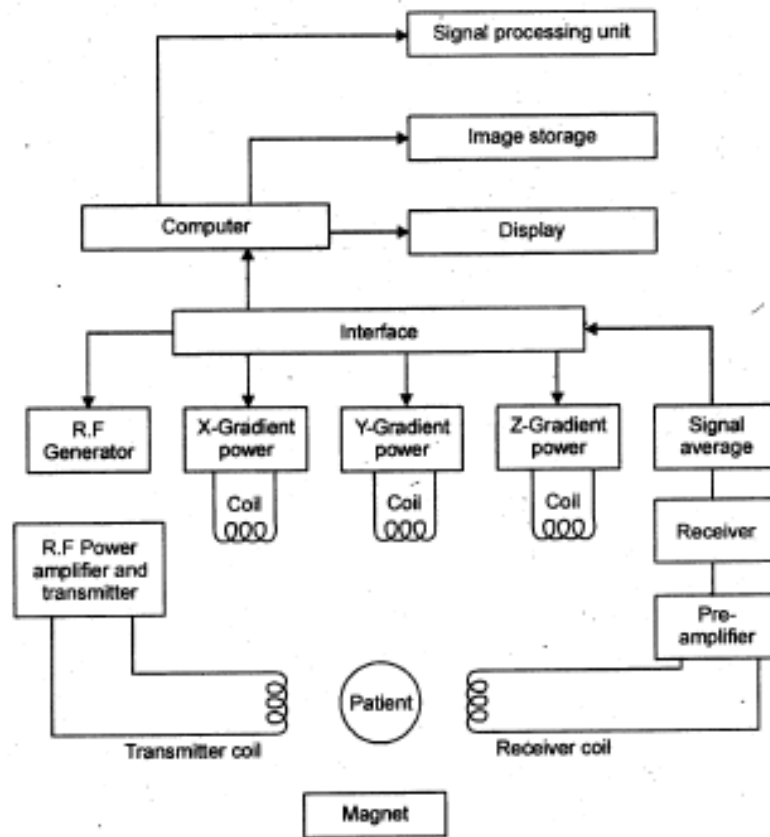

**Figure 5.2 Block Diagram of a MRI Instrumentation**

### **MRI - Magnet**

There are different varieties of magnets used for MRI. They are permanent magnets, electromagnets resistive magnets and super conducting magnets.

### **RF transmitter system**

The RF transmitted system activates the nuclei so that when it comes back to the equilibrium state it gives out NMR signal. The RF transmitter system consists of RF generator, RF transmitter, RF power amplifier and RF transmitting coils. The generator consists of RF crystal oscillator. The RF pulse generated is amplified to levels between 100 W to several kw. The pulse are then fed to the transmitter coil which expose to the patients the RF signals. The RF coils generates and transmit RF fields orthogonal to the direction of the main field. The RF coils are saddle and solenoid shaped.

## RF Detection System

This is used to detect and pick up NMR signals from the human body and to generate an o/p signal for processing by the computer. The detector system consists of receiving coils, matching n/w's amplifier, filter & A to D converters. The receiver coil surrounds the area on interest and picks the NMR signals and converts them to o/p voltage  $V(t)$

$$V(t) = -d/dt \int M(t,x) \cdot B_c(x) dx.$$

$M(t,x)$  → Total magnetization

$B_c(x)$  → Sensitivity of the receiver coil

The detected RF signals are of weak amplitude in the nano voltage range and thus requires specially designed RF antennas. The commonly available RF coils are body coils, surface coils and organ enclosing coil.

## Gradient System

The gradient system is used to have spatial distribution information. By varying the field in a specific fashion, the region from which the information (NMR) is obtained can be selected. There are various methods for selecting a slice, but the selective excitation method is used widely. Here the characteristic of the slice will be determined by the shape of the pulse and the thickness of the slice is determined by the width of the pulse. The gradient system comprises of subsystems. The first subsystem includes the interface which interface the computer and gradient control system. This subsystem helps in positioning of the three time invariant plane (X, Y, Z).

## Imager System

This comprises of the computer, display system and control console. The computer does image processing, timing and control of RF and gradient pulse sequences and it also helps in display. ADC with 16 bits or higher to produce digital NMR. The reconstructed image data are transmitted to the display console. The image can be stored in a floppy disk or magnetic tape. The control console comprises the operation section, system control section and display section. The display section includes high resolution monitor, keyboard, image memory and panel indicators.

## DIALYSIS

Both acute and chronic renal failures can be treated successfully by dialysis which is a process by which the waste products in the blood are removed and restoration of normal pH value of the blood is obtained by an artificial kidney machine. In analysis, three physical processes called

- Diffusion
- Osmosis and
- Ultrafiltration are used to remove the waste products.

There are 2 types of procedures for doing dialysis

1. Extracorporeal dialysis (or) Hemodialysis
2. Intracorporeal dialysis (or) Peritoneal dialysis

## HEMODIALYSIS

### Working

For short term use, a double lumen catheter is inserted into the femoral vein and for long term use, an arteriovenous shunt which is a permanent connection between an artery and a vein and inserted below the skin in the hand by a minor operation, are used to take blood from the artery to the dialyzing unit. There should be perfect protection against bacterial infection. By this way arteriovenous shunt can be used upto 2 years. There should be perfect protection against bacterial infection. By this way arteriovenous shunt can be used upto 2 years. The arteriovenous shunt is opened and connected to the dialyser, using a blood pump the blood is pumped into a no. of planar sheets of cellophane which are pressed together in a frame. Blood flows in alternate spaces and the dialysate flows in the others as shown in diagram. When the volume of the blood flow through the spaces is very small, then the arterial pressure is enough to maintain the flow in the dialyzing unit where the blood pump is not necessary. The dialysate is an electrolyte. Through the cellophane sheets, urea, creatinine, uric acid and phosphates are diffused from the blood to dialysate.

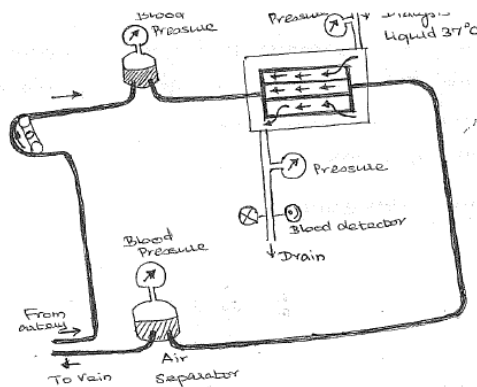

Figure 5.3 Hemodialysis

There is a blood leak, detector to detect rupture of a membrane. Further there are pressure monitoring meters at i/p and o/p. A thermostatic control is provided to maintain the blood at 37°C. There are different forms of semipermeable membrane. It may be in the form of pressed planar sheets or spiral tube in the form of a coil or a bundle of fibers.

## PERITONIAL DIALYSIS

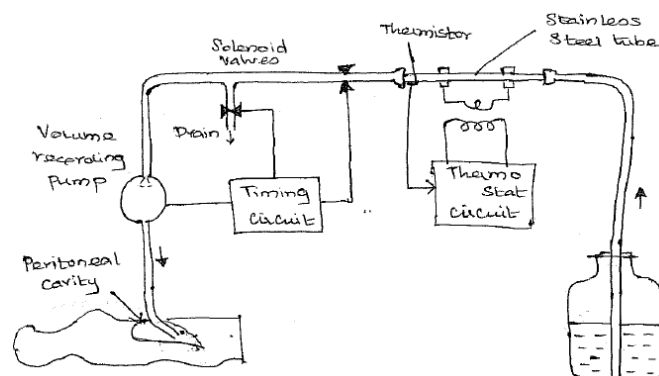

Figure 5.4 Peritoneal Dialysis

The membrane in the peritoneal cavity in the abdomen is used as a semipermeable membranes. A catheter is inserted in the abdomen through a puncture just below the navel. A sterile dialysate about 1.5 to 2 litres is allowed to flow into the peritoneal cavity. The diffusion takes place in 10-30 minutes and the dialysate is then removed from the cavity. This procedure is repeated 20 to 30 times to remove all waste products from the blood. The above procedure is done in an automatic manner using electronic circuitry. First the dialysate is pumped into the abdominal cavity through the volume recording pump. The dialysate is kept at 37°C by thermostatic control. Here thermistor is used as a sensing device.

When the dialysate volume is about 2 litres, a timing circuit will first deliver a signal to stop the dialysate flow into the abdomen. Next the timing circuit allows the diffusion time upto 30 minutes. After that it runs the sucking pump so that the dialysate in the abdominal cavity is pumped and sent out through the drain. Once again the volume of the outgoing dialysate is measured. When the volume of the dialysate is reached 2 litres, then the working of the sucking pump is stopped and fresh dialysate is allowed once again to enter into the abdominal cavity through the volume recording pump. Thus the above procedure is repeated 20 to 30 times. If the volume of the sucked dialysate is less than 2 litres after the diffusion is over, then an alarm circuit will work. Immediately the patient should consult the doctor.

**Table 5.1**

<b>Hemodialysis</b>	<b>Peritoneal dialysis</b>
1. Blood is purified by an artificial kidney machine called hemodialyser in which the blood is taken out from the body and waste products diffuse through a semipermeable membrane which is continuously rinsed by a dialyzing solution or dialysate.	The peritoneal cavity in our body is used as a semipermeable membrane and by passing the dialysate into it, waste products are removed from the blood by diffusion.
2. More effective to separate the waste products.	Less effective
3. Technically complex and risk one because the blood is taken out from the body.	Simple and risk free
4. Dialysing time is about 3 to 6 hours.	Dialysing time is about 9 to 12 hours.

## **SURGICAL DIATHERMY**

Diathermy is the treatment process by which cutting, coagulation etc of tissues are obtained.

### **Cutting**

It is found that when high frequency current in the range 1-3 MHz is applied, heating of the tissue takes place. The evolving steam bubbles in the tissues at the surgical tip continuously rupture the tissue and by that way the cutting action is obtained.

## Coagulation

During the passage of the high frequency current through the tissue, the tissue is heated locally. So that the tissue is melted instantaneously and sealing of the capillary and other blood vessels is taking place. Thus the coagulation of the tissue takes place.

### Various Electrosurgery Techniques using Diathermy Unit

1. **Fulguration:** By passing sparks from a needle or ball electrode of small diameter to the tissues, the developed heat dries out the superficial tissue without affecting deep-seated tissues. This is called 'Fulguration' in which the electrode is held near the tissue without touching it and due to the passage of the electric arc, the destruction of passage of the electric arc, the destruction of superficial tissue takes place.
2. **Desiccation:** The needle point electrodes are stuck into the tissue and kept steady while passing electric current. This creates a high local increase in heat and drying of tissues is taking place. This is called 'desiccation' which produces dehydration in the tissues.
3. **Electrotomy:** When the electrode is kept above the skin, an electrical arc is sent. The developed heat produces a wedge shaped narrow cutting of the tissue on the surface. By increasing the current level, deeper level cutting of the tissues take place.
4. **Coagulation:** When the electrode is kept near the skin, high frequency current is sent through the tissue in the form of bursts and heating it locally so that it coagulates from inside. The concurrent use of continuous R.F current for cutting and a R.F. wave burst for coagulation is called hemostasis mode.
5. **Blending:** When the electrode is kept above the skin, the separated tissues or nerves can be welded or combined together by an electric arc. This is called blending.

### Different types of waveforms used in Electrosurgical diathermy techniques

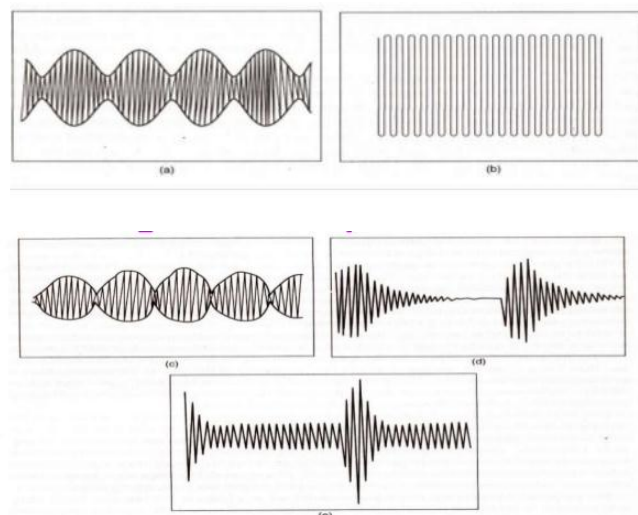

**Figure 5.5 Different types of waveforms used in Electrosurgical diathermy techniques**

- (a) Cutting R.F waveform A modulated by 100 Hz
- (c) & (d) Coagulation waveforms
- (e) Blending waveform

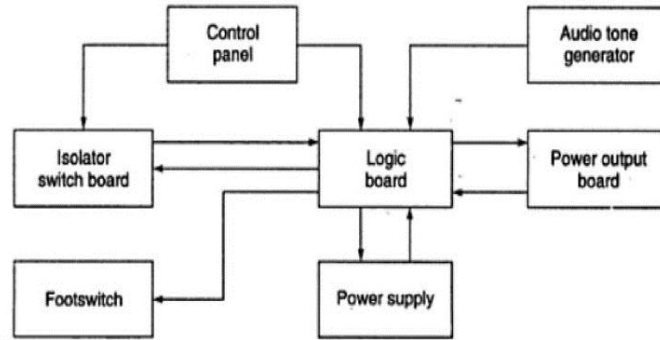

**Figure 5.6 Block diagram of electro-surgical diathermy unit**

The logic board is the main part of the unit which produces the necessary waveforms for cutting, coagulation and hemostasis modes of operation. An astable multivibrator generates 500 kHz square pulses. The o/p from this oscillator is divided into a number of frequencies using binary counters. These frequencies are used as system timing signals. A frequency of 250 kHz provides a split phase signal to drive o/p stages on the power o/p board. The frequency of 250 kHz is used for cutting, after the high power amplification by push pull amplifier. The o/p of the push-pull amplifier.

The o/p of the push-pull amplifier is given to a transformer so that the voltage is stepped up and the o/p signal from the unit is well isolated. To indicate the each mode of operation, the diathermy unit is provided with an audio tone generator. When the coagulation o/p is delivered 1 kHz audio signal is heard from it. Similarly 500 Hz for cutting and 250 Hz for hemostasis. The isolator switch provides an isolated switching control between the active hand switch and the rest of the unit. The logic board receives information from the foot switch, finger switch and alarm sensing points. The construction of the foot switch is to avoid any explosion formed by the existence of anaesthesia gases near the electrical contacts.

### **Sources of Electric hazards and safety techniques**

(1) There are a number of design features to secure safety for the patient or operator during the operation of the unit. The o/p circuit in the diathermy unit is isolated and insulated from the low frequency primary and secondary voltages. (2) The bipolar electrodes are used such that the active electrode is mounted in an insulated handle having a finger tip switch and indifferent electrode is placed at the back of the patient in the form of a plate. (3) The o/p of the unit may be earth referenced or isolated. The isolated o/p does not produce any fibrillation and any serious burns. But there is a chance of getting shocks and small burns. In isolated o/p, the indifferent electrode is in the floating condition. In earth referenced o/p, the indifferent electrode is connected to the ground via a capacitor.

(4) The active electrodes for cutting are in the form of needle electrode used for desiccation. Angulated and straight lancet electrodes are used for cutting. Angulated loop electrodes used for opening up the channels. The active electrode for coagulation are in the form of a ball or plate. (5) There are circuit integrity monitors like (i) Electrode cable continuity monitor, (ii) Patient circuit continuity monitor, (iii) Alternate path currents monitor etc. (6) The frequency of operation is from 20 kHz to 1 MHz (i) The o/p power for cutting → 400 W in 500 Ω load at 2000 V. (ii) For coagulation → 150 W with a burst duration is 10-15 μs. Repetition frequency of the burst is 15 kHz.



## **Source of Electric hazards and safety techniques**

One of the main hazards connected with the use of medical equipment is electrical shock. Shock is defined in terms of current because the voltages that produce the current are highly variable.

### **Microshock**

A physiological response to a current applied to the surface of the heart that produces unwanted or unnecessary stimulation like muscle contractions or tissue injury is called microshock. Currents on the order of excess of 10  $\mu$ a could be dangerous. All hospital patients and medical attendants are exposed to microshocks, from defective electric devices and biomedical equipment.

### **Hazards**

Most of the accidents occur due to improper grounding and leakage currents. Leakage current flow is due to (i) Ungrounded equipment (ii) Broken ground wire and (iii) Unequal ground potentials. Static electricity may be dangerous to people and sensitive equipment having integrated circuits. Sparks from static electricity could ignite flammable gases, causing an explosion. Interruption of electrical power to life support equipment can be hazardous.

### **Microshock**

A physiological response to a current applied to the surface of the body that produces unwanted or unnecessary stimulation like muscle contractions or tissue injury is called macroshock.

### **Hazards**

Macroshock occurs more often with two-wire systems. With two-wire equipment it is always dangerous to get between the hot H and neutral N wires. Macroshock hazard exists when the chassis and ground are touched simultaneously.

## **Devices to protect against electrical hazards**

Several devices are available to protect patients and health care workers from hazardous electrical currents.

### **Ground Fault Interrupter (GFI)**

GFI protects against a shock that occurs if a person touches the hot lead with one hand and the ground with the other.

### **Isolation Transformer**

Provides a second means of protecting against an H-lead to G-lead macroshock. It also prevents sparks when the lead touches ground, a particularly important protection in an explosive or flammable environment such as when flammable anesthetics or excessive oxygen is present.

### **Line Isolation Monitor (LIM)**

LIM puts a relatively large impedance from either secondary lead through an ammeter to ground of the isolation transformer.

## **TEXT / REFERENCE BOOKS**

1. Khandpur, "Handbook of Biomedical Instrumentation" 2nd Edition, Tata McGraw Hill, 2003.
2. Arumugam M, "Biomedical Instrumentation", Anuradha Publications, Reprint 2009.
3. Tompkins W J and Webster J G, "Design of Microcomputer Based Medical Instrumentation", Prentice Hall, 1991
4. Geddes L A and Baker L E, "Principle of Applied Biomedical Instrumentation" 3rd Edition, Wiley, 1989
5. Hill D.W, "Principle of Electronics for Medical Research", 2nd Edition, Butterworths, 1965.

## QUESTON BANK

### PART – A

1. Define SODIUM PUMP.
2. What are neurons & axons?
3. Give any two names of passive transducers.
4. What is the need of pre amplifier?
5. What is Einthoven triangle?
6. What is cardiac output rate?
7. What is Ph of blood?
8. What is Defibrillators?
9. Define Diathermy.
10. What are the safety techniques are available in medical field?
11. What do you mean by resting potential?
12. What are perfectly polarized electrodes?
13. What do you mean by a transducer?
14. What do you mean by piezoelectric effect?
15. How do you detect tumor using EEG?
16. What do you mean by plethysmo graphy?
17. What are the differences between external pacemaker and internal pacemaker?
18. What are the uses of blood gas analyzers?
19. What are the various electro surgery techniques using diathermy unit?
20. Why are superconducting magnets used in MRI?
21. Which system is known as hydraulic system in our body? State its use.
22. What is meant by electrical double layer?
23. Distinguish between metallic and non-metallic microelectrode.
24. Define pH. Give its range for human blood.
25. Specify the average resting cardiac output for a human male and female.
26. List the six applications of electromagnetic blood flow meters.
27. Which stimulation is used in case of long term pacing in pacemakers and why?
28. Mention the drawbacks of CT scanner.
29. What is the necessity of artificial heat exchanger?
30. Name the different types of biotelemetry systems.
31. What are perfectly polarized electrodes?
32. What do you mean by resting potential?
33. What is the function of depth and needle electrode?
34. What do you mean by piezoelectric effect?
35. What do you mean by vector cardiography?
36. What do you mean by Einthovens triangle?
37. What do you mean by a pacemaker?
38. What are the uses of blood gas analyzers?
39. What are the advantages of laser surgery?
40. What are the effects of radiation exposure?

### PART – B

1. Explain about the cell and their structure with neat diagram.  
(or)
2. Explain about the organization of nervous system in detail.

3. Explain about the different types of electrodes in detail.  
(or)
4. Explain about the working principle of piezoelectric transducer with neat diagram.
5. Explain about ECG lead configurations with neat diagram.  
(or)
6. Explain about the any one type of blood flow measurements in detail.
7. Explain about ultrasonic diagnosis in medical field.  
(or)
8. Explain about the types pacemakers with neat diagram.
9. Explain about any one type of dialyzer.  
(or)
10. Explain about the surgical Diathermy in detail.
11. Explain in detail how resting and action potentials are generated?  
(or)
12. Explain in detail about the structure of neuron with neat sketches.
13. Discuss in detail the different types of surface electrodes and their uses  
(or)
14. Explain in detail about the different types of chopper amplifier.
15. Explain in detail about EMG with neat sketches?  
(or)
16. Enumerate the differences between radiography and fluoroscopy.
17. Explain in detail the different types of defibrillators with neat sketches  
(or)
18. Explain in detail the types of oximetry with neat sketches.
19. Explain in detail about surgical diathermy with neat sketches.  
(or)
20. Enumerate the applications of laser in medicine.
21. What are bioelectric potentials? Discuss the origin, frequency, voltage and clinical significances of ECG, EEG and EMG signals.  
(or)
22. With neat sketch explain in detail about the physiology of Heart.
23. Discuss about the types of transducers used for extra arterial and intravenous pressure measurement in detail.  
(or)
24. Explain the measurement of  $PCO_2$  and  $PO_2$  with suitable figures.
25. Bring out the salient features of Phonocardiography. Discuss in detail about cardiac output measurement by dilution method and Ficks method.  
(or)

26. Describe any two methods to determine the percentage of oxygen saturation of the circulating arterial blood.
27. Explain with neat block diagram the instrumentation set up of an instrument which uses blemsstrahlung radiation as source.  
(or)
28. Draw the block diagram of a MRI system and explain the image reconstruction using it.
29. Elaborate the importance of ventilator in respiratory failure along with its types.  
(or)
30. Write short notes on the following:  
1. Tunnel diode FM Transmitter  
2. Hartley type FM Transmitter
31. Explain in detail about central nervous system with neat sketches.  
(or)
32. Explain in detail about the structure of neuron with neat sketches.
33. Discuss in detail the different types of surface electrodes and their uses.  
(or)
34. Write short notes on  
(i) Pre amplifier. (ii) Current amplifier
35. Explain in detail about EEG with neat sketches?  
(or)
36. Explain in detail about Computer Tomography with neat sketches.
37. Explain with block diagram a biotelemetry system to transmit heart rate.  
(or)
38. Explain in detail the types of oximetry with neat sketches.
39. Explain the principle of MRI.  
(or)
40. Enumerate the applications of laser in medicine.