



SNS COLLEGE OF TECHNOLOGY

(An Autonomous Institution)

COIMBATORE-35

Accredited by NBA-AICTE and Accredited by NAAC – UGC with A+ Grade
Approved by AICTE, New Delhi & Affiliated to Anna University, Chennai



19GET277 / Biology For Engineers IV YEAR / VII SEMESTER UNIT-III: GENETICS AND IMMUNE SYSTEM

VARIATION AND SPECIATION-NUCLEIC ACIDS AS A GENETIC MATERIAL

Reference – Molecular Biology of the Gene (6th Edition) by Watson et. al. Pearson education, Inc

The Search for the Genetic Material

1. Some substance must be responsible for passage of traits from parents to offspring.

For a substance to do this it must be:

a. Stable enough to store information for long periods.

b. Able to replicate accurately.

c. Capable of change to allow evolution.

What constituent of the cell carries the genetic information ?

Genes – high stability requirement yet capable of permanent sudden change to mutant forms to provide the basis of evolution.

Proteins – Strong evidence initially in favor of proteins by Archibald E Garrod and Beadle and Tatum theory of genes controlling Enzyme synthesis.

DNA – Griffiths experiments and later Avery et al experiments to prove DNA as genetic material in living cells and some phages and viruses.

RNA – In some viruses (TMV)

History of DNA Structure

Gregor Mendel – 1857: Father of genetics – Unit of inheritance in peas

Friedrich Miescher (1844-1895) discovered a substance he called "nuclein" in 1869 which has a unique ratio of nitrogen and phosphorus. Later he isolated a pure sample of the material now known as DNA from the sperm of salmon.

1889 his pupil, Richard Altmann, named it "nucleic acid". This substance was found to exist only in the chromosomes.

Frederick Griffith, a scientist, was working on a project in 1928 that formed the basis that DNA was the molecule of inheritance.

In 1929 Phoebus Levene at the Rockefeller Institute identified the components that make up a DNA Molecule. Those components are:

The four bases: Adenine (A), Cytosine (C), Guanine (G), Thymine (T)
Sugar, Phosphate

The molecule now known as DNA was first identified in the 1860s by a Swiss chemist called Johann Friedrich Miescher.



Johann carried out experiments using salt solutions to understand more about what makes up nucleus of white blood cells. He noticed that, when he added acid to a solution of the cells, a substance separated from the solution. This substance then dissolved again when an alkali was added. When investigating this substance he realised that it had unexpected properties different to those of the other proteins he was familiar with. It was found to be rich in phosphorus and devoid of sulfur

Johann called this mysterious substance ‘nuclein’, because he believed it had come from the cell nucleus.

Miescher was a visionary and already in 1869 he proposed that "nuclein" might be the basis of heredity.



Albrecht Kossel was a German biochemist who made great progress in understanding the basic building blocks of nuclein.

In 1885 - 1901 Albrecht identified nuclein as a nucleic acid and provided its present chemical name, deoxyribonucleic acid (DNA). He also isolated the five nucleotide bases that are the building blocks of DNA and RNA: adenine (A), cytosine (C), guanine (G), thymine (T) and uracil (U).

This work was rewarded in 1910 when he received the Nobel Prize in Physiology or Medicine.

In studying the yeast nucleic acid, he established its empirical formula as $C_{38}H_{50}O_{29}N_{15}P_4$ and he found the four bases, guanine, adenine, cytosine, and uracil—it was a ribonucleic acid, RNA—in equimolecular proportions. He identified the sugar content as pentose and determined the presence of phosphoric acid.



Phoebus A. Levene

Levene identified the four bases by their empirical formulas and was mistaken only in the formula of cytosine and by a single hydrogen atom only. This was the beginning of the tetranucleotide hypothesis

A few years after he published his results on the yeast nucleic acid, Levene, together with W. A. Jacobs reported the results of their investigation of thymus nucleic acid . This was a desoxyribonucleic acid, DNA, so thymine appeared in it in place of uracil.

In the early 1900s, the work of Gregor Mendel was rediscovered and his ideas about inheritance began to be properly appreciated. As a result, a flood of research began to try and prove or disprove his theories of how physical characteristics are inherited from one generation to the next.

In the middle of the nineteenth century, Walther Flemming, an anatomist from Germany, discovered a fibrous structure within the nucleus of cells. He named this structure ‘chromatin’, but what he had actually discovered is what we now know as chromosomes. By observing this chromatin, Walther correctly worked out how chromosomes separate during cell division, also known as mitosis.

The chromosome theory of inheritance was developed primarily by Walter Sutton and Theodor Boveri. They first presented the idea that the genetic material passed down from parent to child is within the chromosomes. Their work helped explain the inheritance patterns that Gregor Mendel had observed over a century before.

Interestingly, Walter Sutton and Theodor Boveri were actually working independently during the early 1900s. Walter studied grasshopper chromosomes, while Theodor studied roundworm embryos. However, their work came together in a perfect union, along with the findings of a few other scientists, to form the chromosome theory of inheritance.

In the closing statement of his 1902 paper he summed up the chromosomal theory of inheritance based around these principles:

- Chromosomes contain the genetic material.**
- Chromosomes are passed along from parent to offspring.**
- Chromosomes are found in pairs in the nucleus of most cells (during meiosis these pairs separate to form daughter cells).**
- During the formation of sperm and eggs cells in men and women, respectively, chromosomes separate.**
- Each parent contributes one set of chromosomes to its offspring.**

DNA - A Genetic Material in Living Cells and Phages

Griffith's Transformation Experiment

- 1. Frederick Griffith's 1928 experiment with *Streptococcus pneumoniae* bacteria in mice showed that something passed from dead bacteria into nearby living ones, allowing them to change their cell surface.**
- 2. He called this agent the transforming principle, but did not know what it was or how it worked.**

Experiment of English Microbiologist Frederick Griffith in 1928 - Transforming Principle

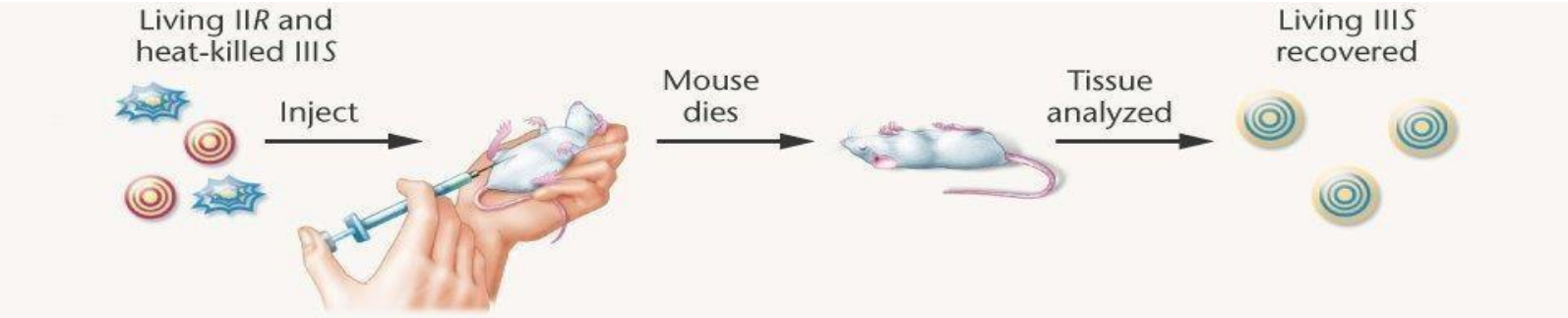
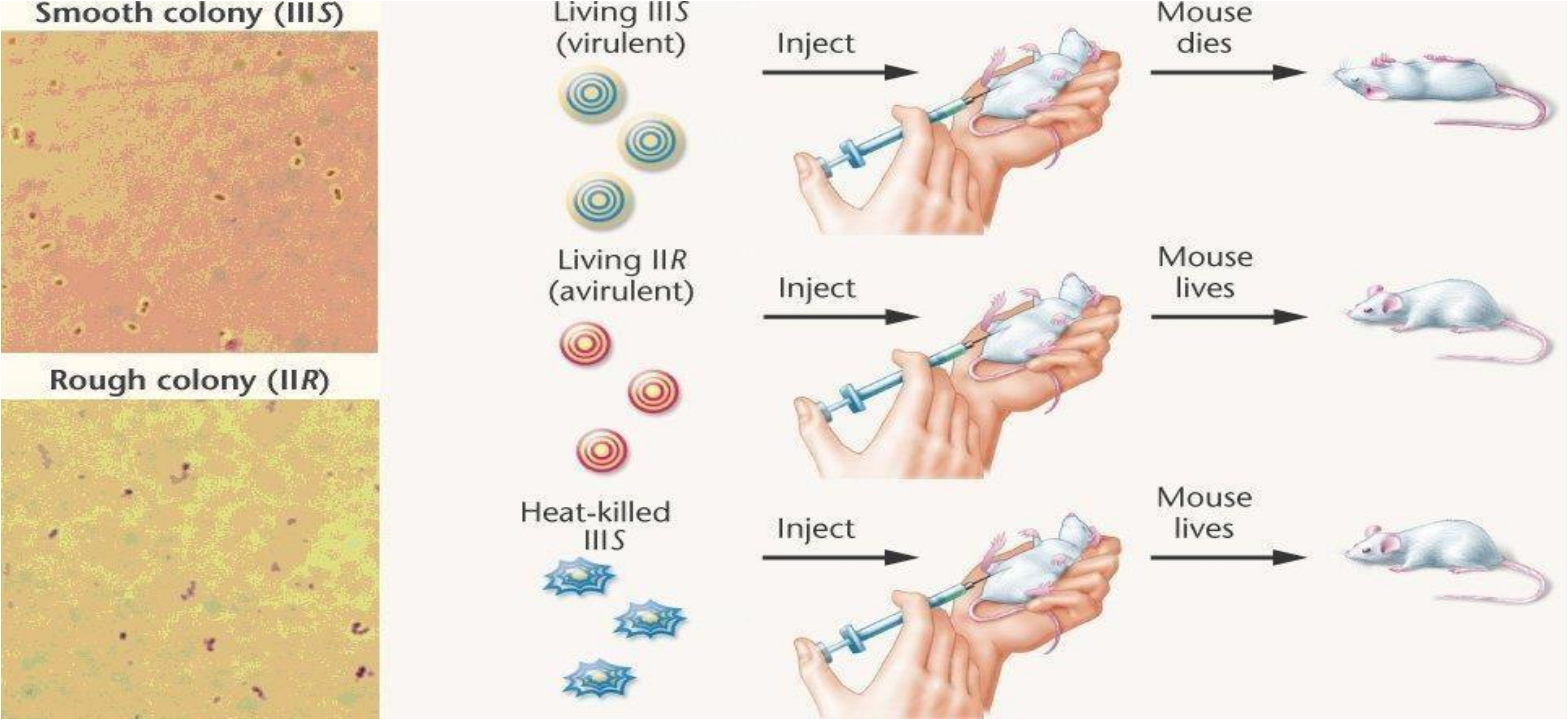

The Griffith Experiment 1928

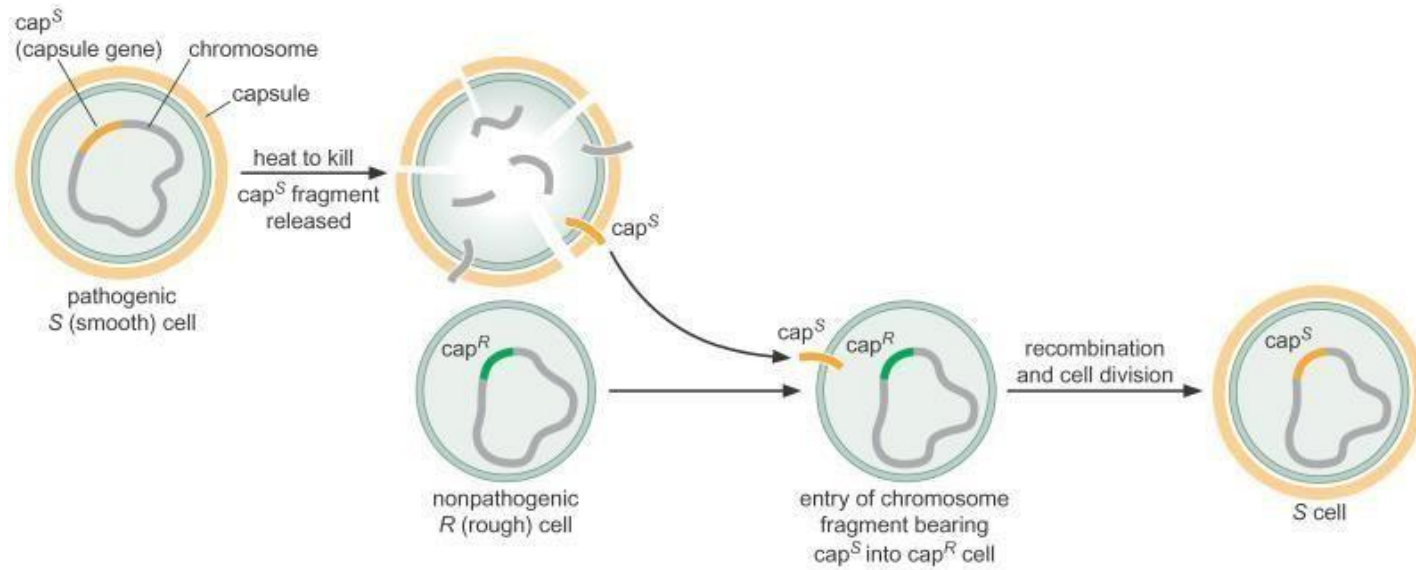

Avery's Transformation Experiment

Animation: DNA as Genetic Material: The Avery Experiment

1. In 1944, Avery, MacLeod and McCarty published results of a study that identified the transforming principle from *S. pneumoniae*. Their approach was to break open dead cells, chemically separate the components (e.g., protein, nucleic acids) and determine which was capable of transforming live *S. pneumoniae* cells.
2. Only the nucleic acid fraction was capable of transforming the bacteria.
3. Critics noted that the nucleic acid fraction was contaminated with proteins. The researchers treated this fraction with either RNase or protease and still found transforming activity, but when it was treated with DNase, no transformation occurred, indicating that the transforming principle was DNA.

Experiments of US Microbiologists Oswald T Avery, Colin M MacLeod and Maclyn McCarty in 1944 at the Rockefeller Institute in New York – DNA active transforming principle

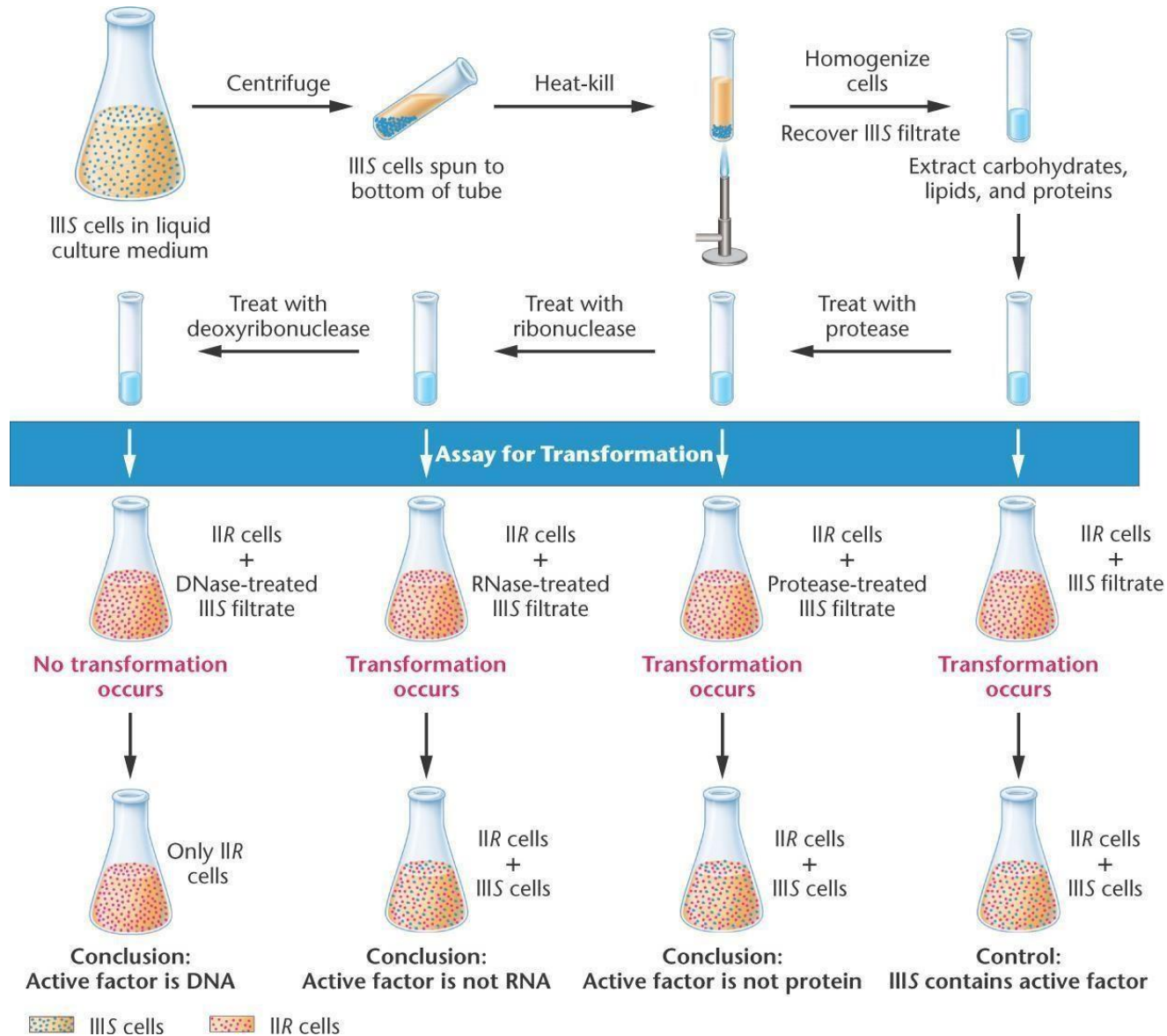

The Avery, MacLeod and McCarty Experiment 1944

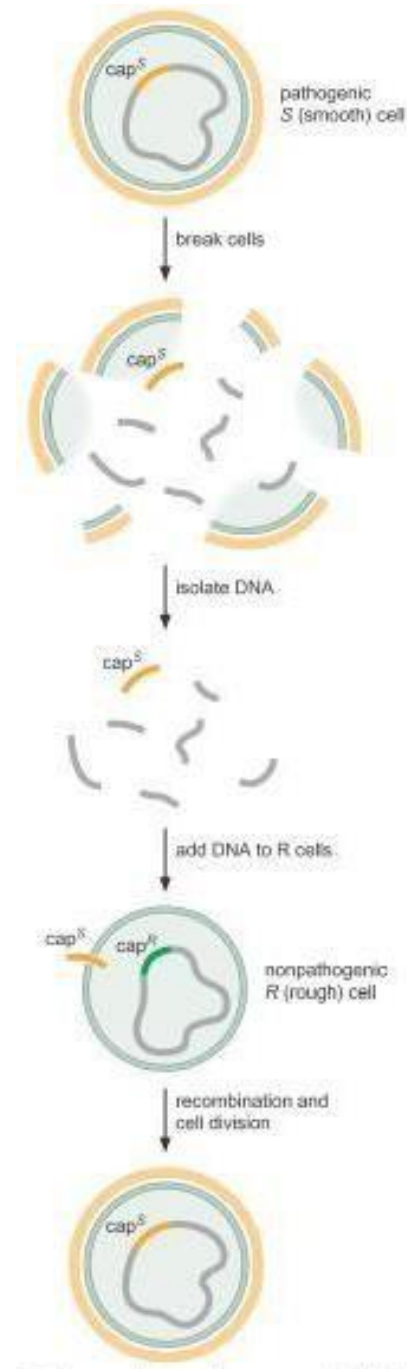

The Hershey-Chase Bacteriophage Experiment

Animation: DNA as Genetic Material: The Hershey-Chase Experiment

1. **More evidence for DNA as the genetic material came in 1953 with Alfred Hershey and Martha Chase's work on *E. coli* infected with bacteriophage T2.**
2. **In one part of the experiment, T2 proteins were labeled with ^{35}S , and in the other part, T2 DNA was labeled with ^{32}P . Then each group of labeled viruses was mixed separately with the *E. coli* host. After a short time, phage attachment was disrupted with a kitchen blender, and the location of the label determined.**
3. **The ^{35}S -labeled protein was found outside the infected cells, while the ^{32}P -labeled DNA was inside the *E. coli*, indicating that DNA carried the information needed for viral infection. This provided additional support for the idea that genetic inheritance occurs via DNA.**

Experiments of Alfred Hershey and Martha Chase in 1952 at Cold Spring Harbor Laboratory on Long Island - DNA genetic material in Phages

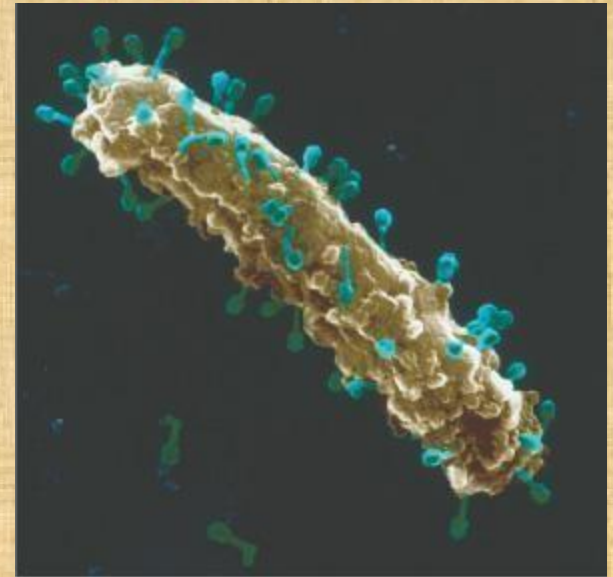
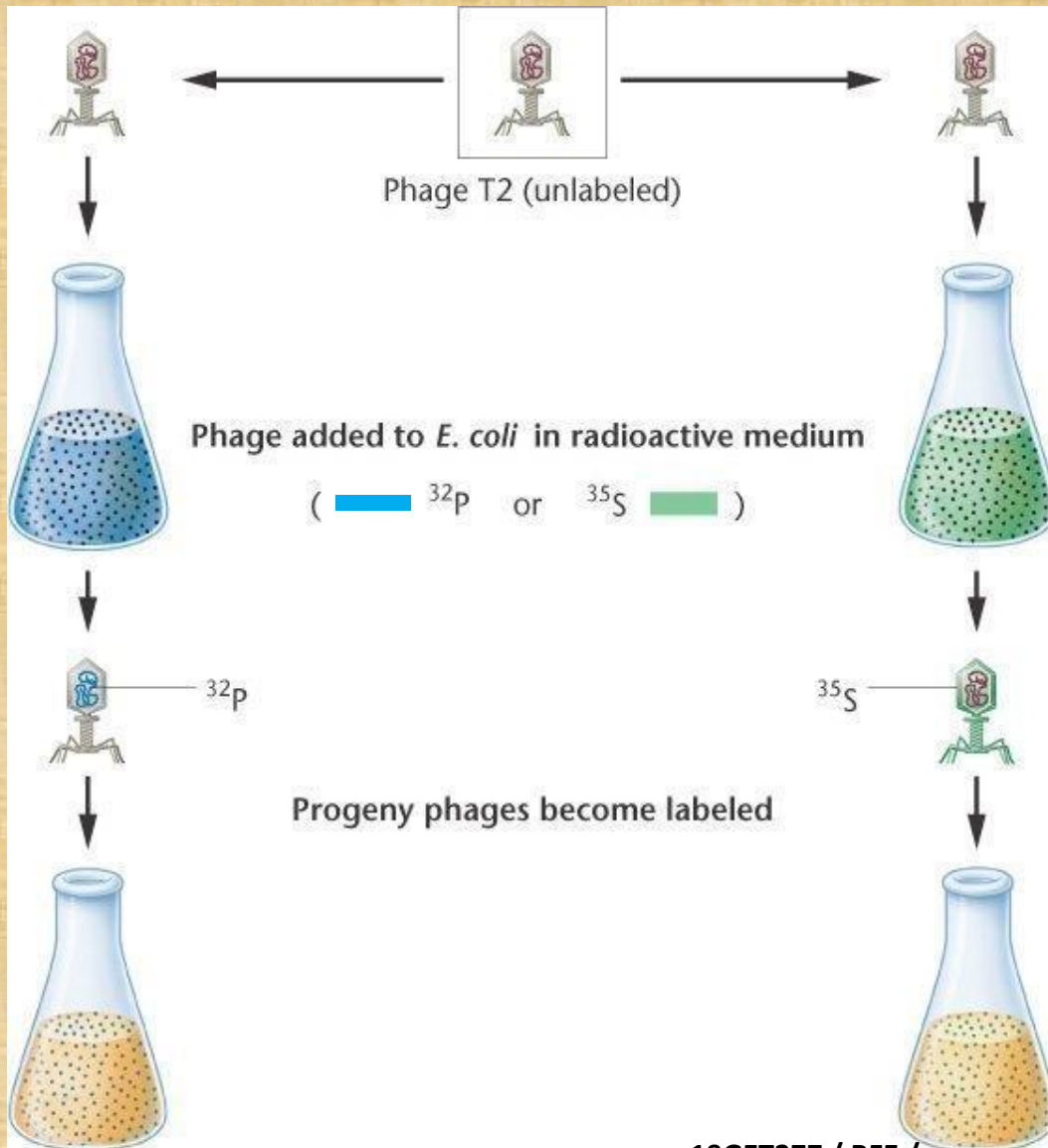

T even phages infecting *E. coli* cell



Alfred Hershey
Nobel Prize in Physiology or
Medicine 1969

1919

Hershey and Chase experiment continue

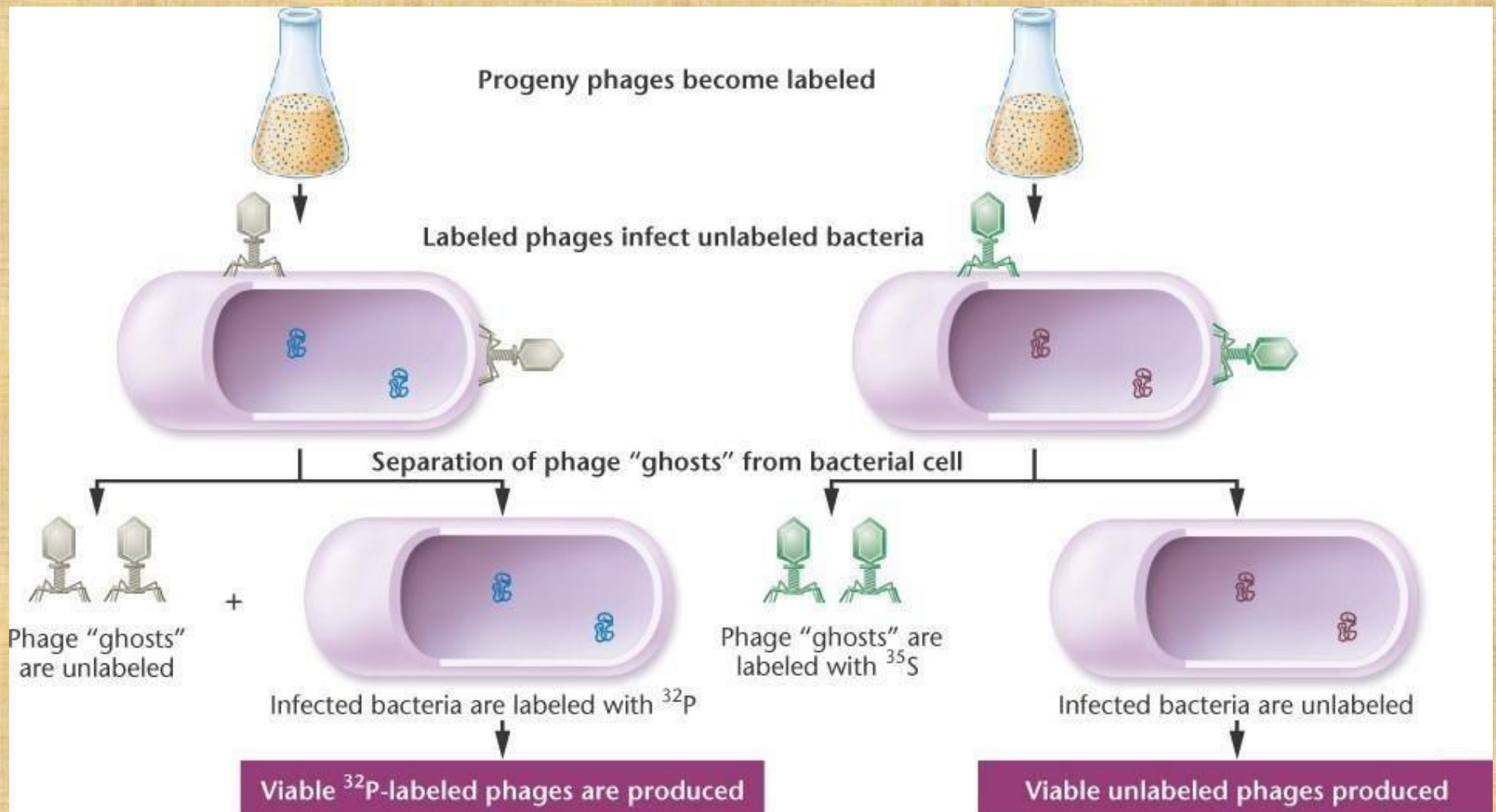

Hershey-Chase experiment demonstrating DNA is genetic material

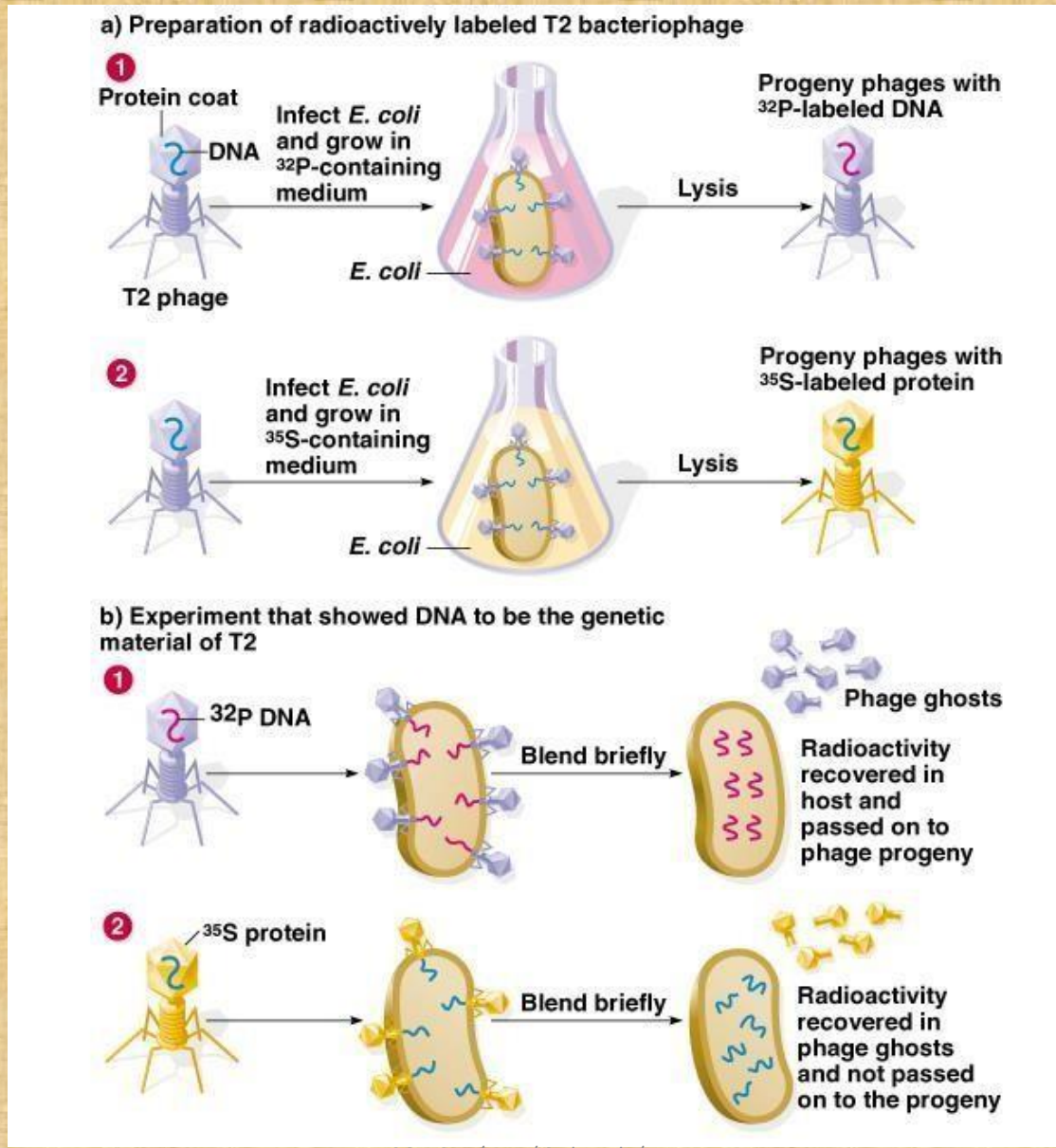

The Discovery of RNA as Viral Genetic Material

- 1. All known cellular organisms have DNA as their genetic material. Some viruses, however, use RNA instead.**
- 2. Tobacco mosaic virus (TMV) is composed of RNA and protein; it contains no DNA. In 1956 Gierer and Schramm showed that when purified RNA from TMV is applied directly to tobacco leaves, they develop mosaic disease. Pretreating the purified RNA with RNase destroys its ability to cause TMV lesions.**
- 3. In 1957 Fraenkel-Conrat and Singer showed that in TMV infections with viruses containing RNA from one strain and protein from another, the progeny viruses were always of the type specified by the RNA, not by the protein.**

Gierer & Schramm Tobacco Mosaic Virus (TMV) Experiment - 1956 Fraenkel-Conrat & Singer - 1957

Demonstrated that RNA is the genetic material of TMV.

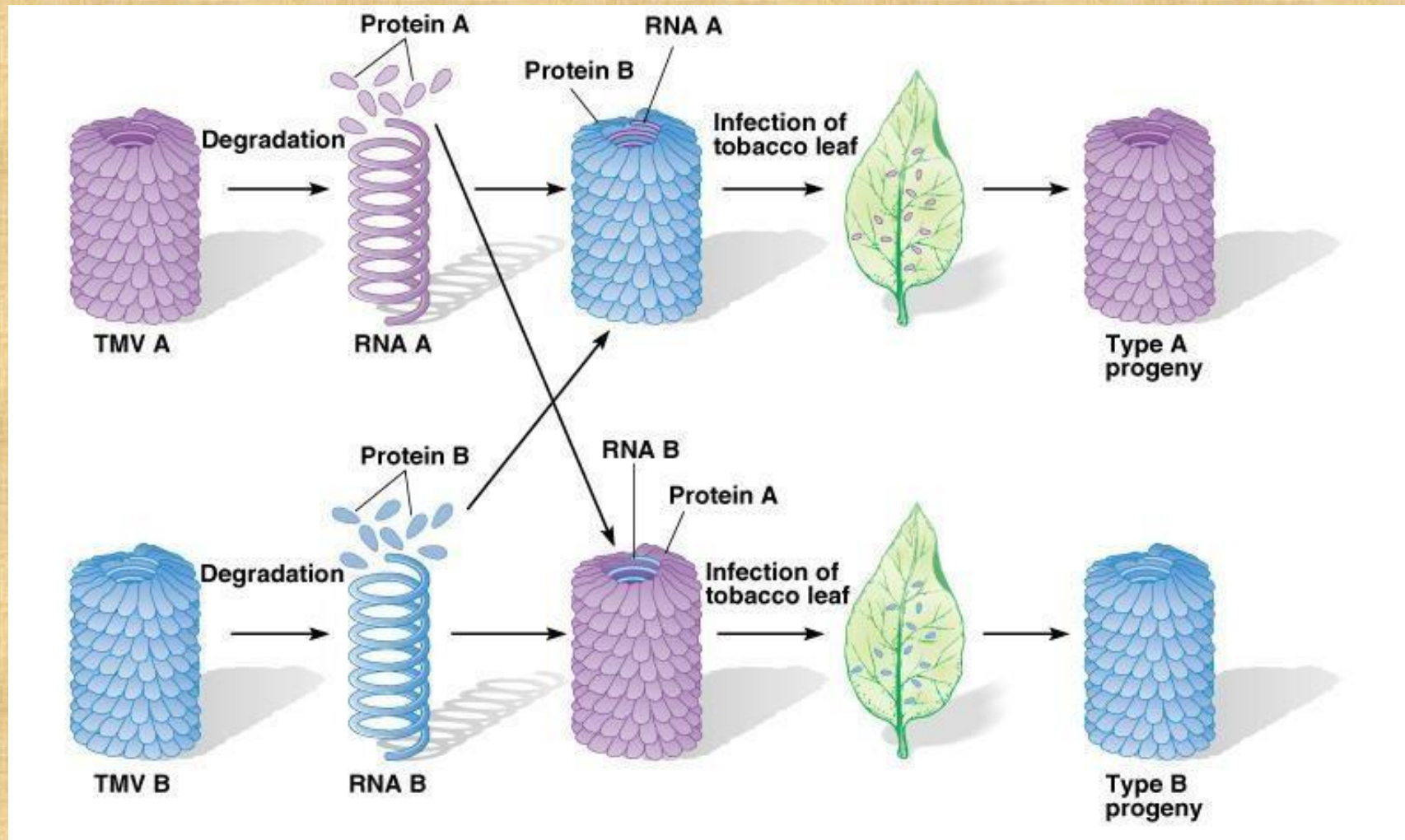

The Composition and Structure of DNA and RNA

- 1. DNA and RNA are polymers composed of monomers called nucleotides.**
- 2. Each nucleotide has three parts:**
 - a. A pentose (5-carbon) sugar.**
 - b. A nitrogenous base.**
 - c. A phosphate group.**
- 3. The pentose sugar in RNA is ribose, and in DNA it's deoxyribose. The only difference is at the 2' position, where RNA has a hydroxyl (OH) group, while DNA has only a hydrogen.**

Structures of deoxy-ribose and ribose in DNA and RNA

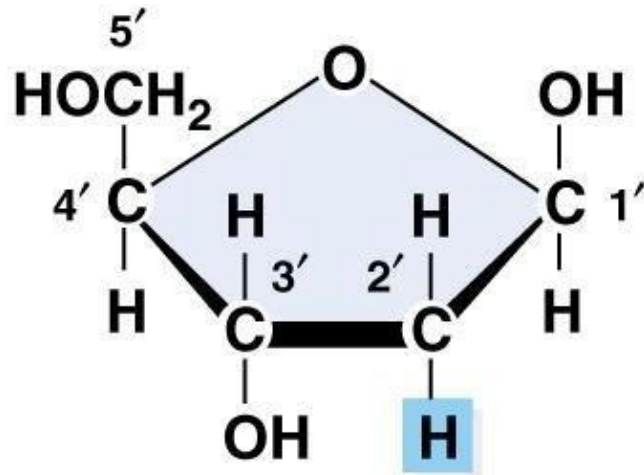

Deoxyribose

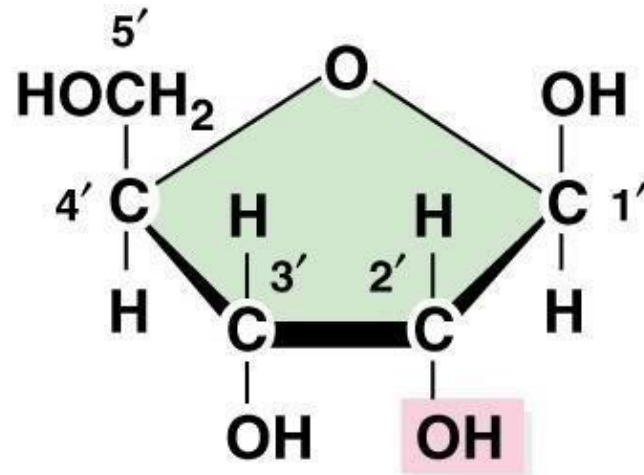

Ribose

Nucleosides & Nucleotides

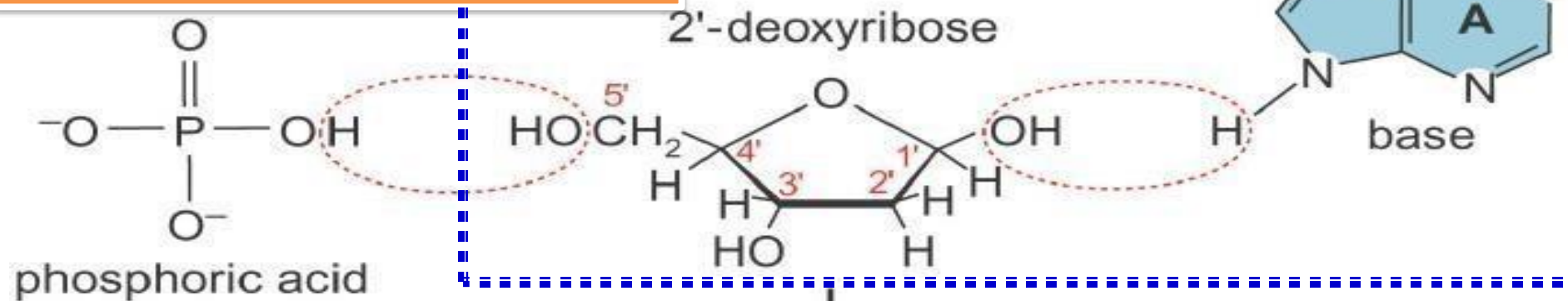

phosphoester bond

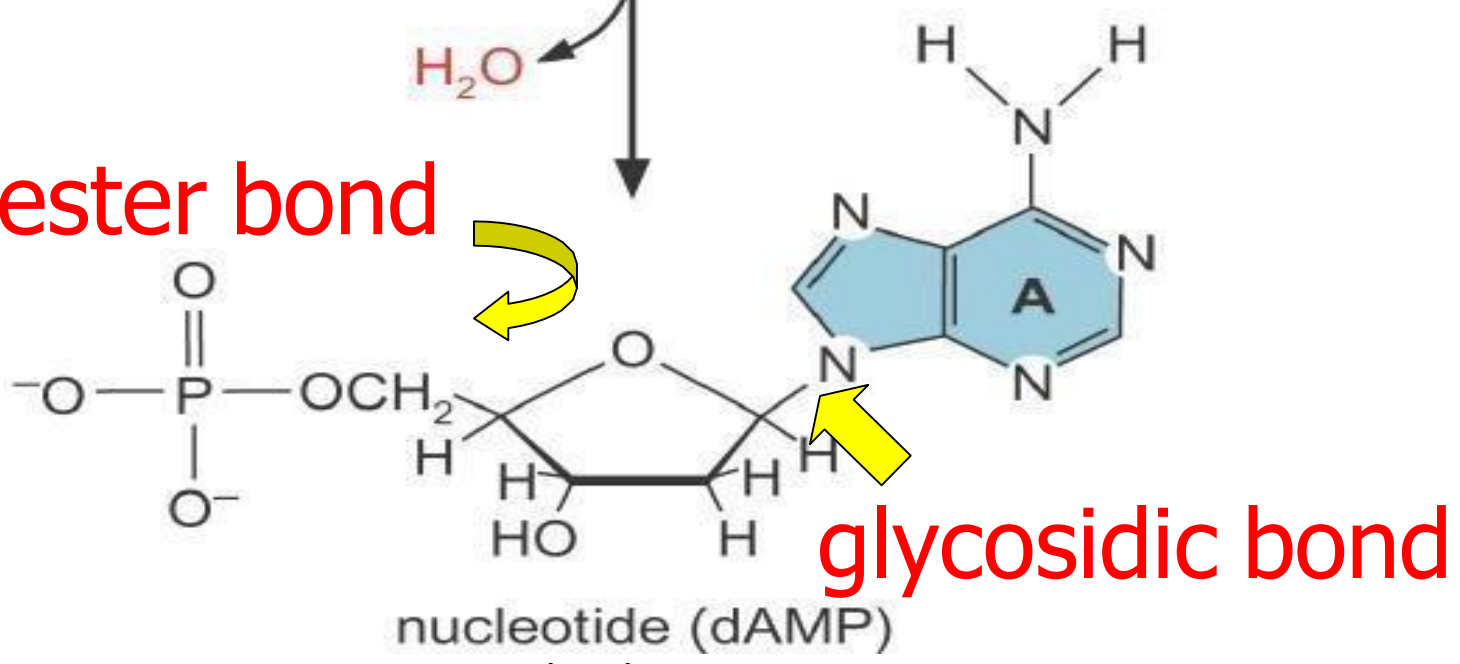

The Composition and Structure of DNA and RNA

- 4. There are two classes of nitrogenous bases:**
- a. Purines (double-ring, nine-membered structures) include adenine (A) and guanine (G).**

 - b. Pyrimidines (one-ring, six-membered structures) include cytosine (C), thymine (T) in DNA and uracil (U) in RNA.**

Figs. 2.10 Structures of the nitrogenous bases in DNA and RNA

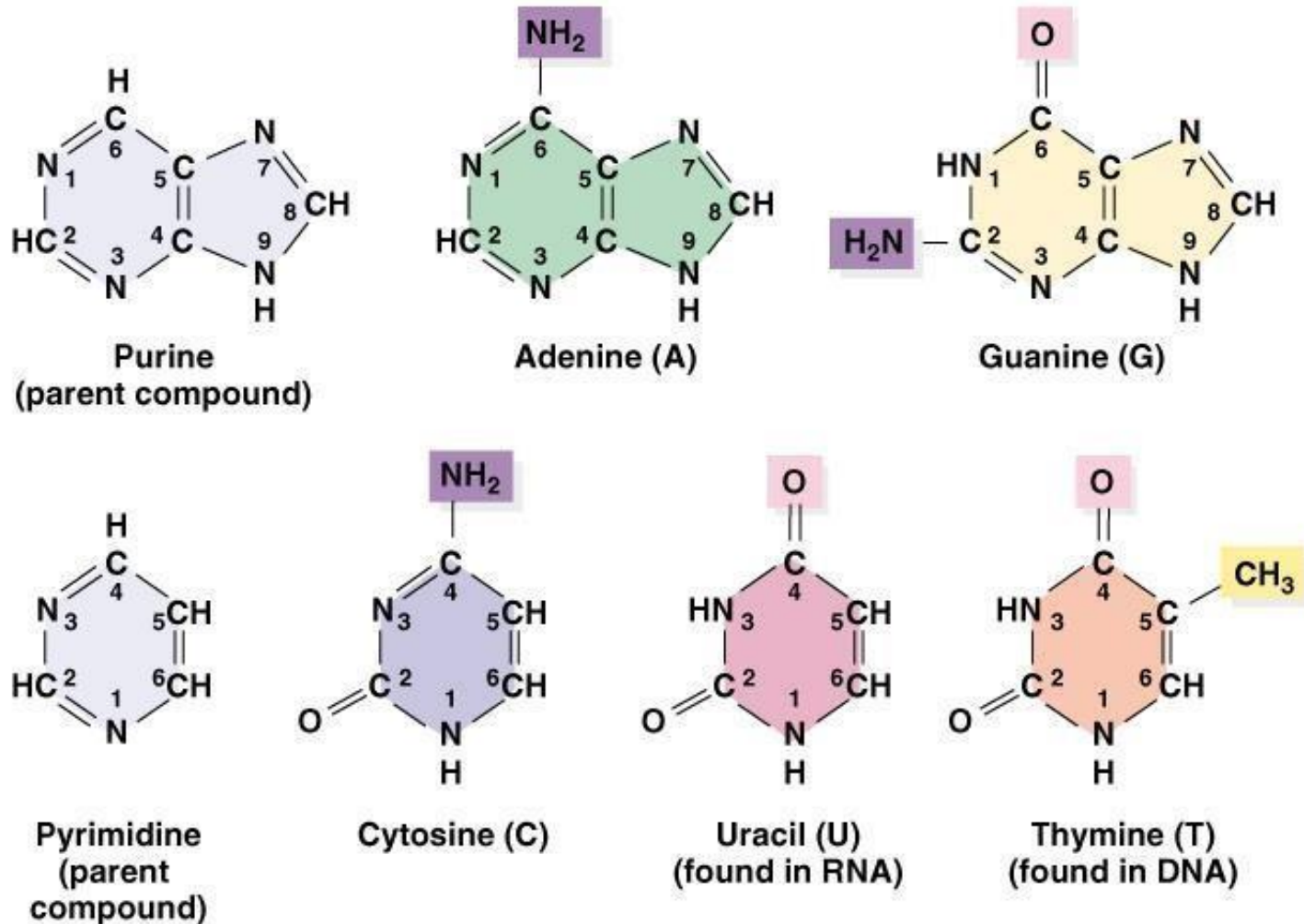

The Composition and Structure of DNA and

RNA

5. The structure of nucleotides has these features:

- a. The base is always attached by a covalent bond between the 1' carbon of the pentose sugar and a nitrogen in the base (specifically, the nine nitrogen in purines and the one nitrogen in pyrimidines).
- b. The sugar-base combination is a nucleoside. When a phosphate is added (always to the 5' carbon of the pentose sugar), it becomes a nucleoside phosphate, or simply nucleotide.

6. Polynucleotides of both DNA and RNA are formed by stable covalent bonds (phosphodiester linkages) between the phosphate group on the 5' carbon of one nucleotide, and the 3' hydroxyl on another nucleotide. This creates the “backbone” of a nucleic acid molecule.

7. The asymmetry of phosphodiester bonds creates 3'-5' polarity within the nucleic acid chain.

Nucleosides & Nucleotides

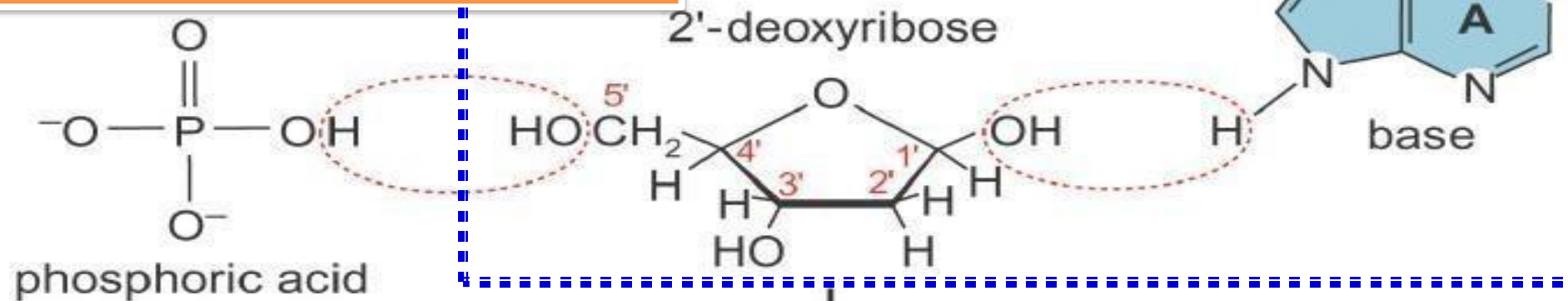

phosphoester bond

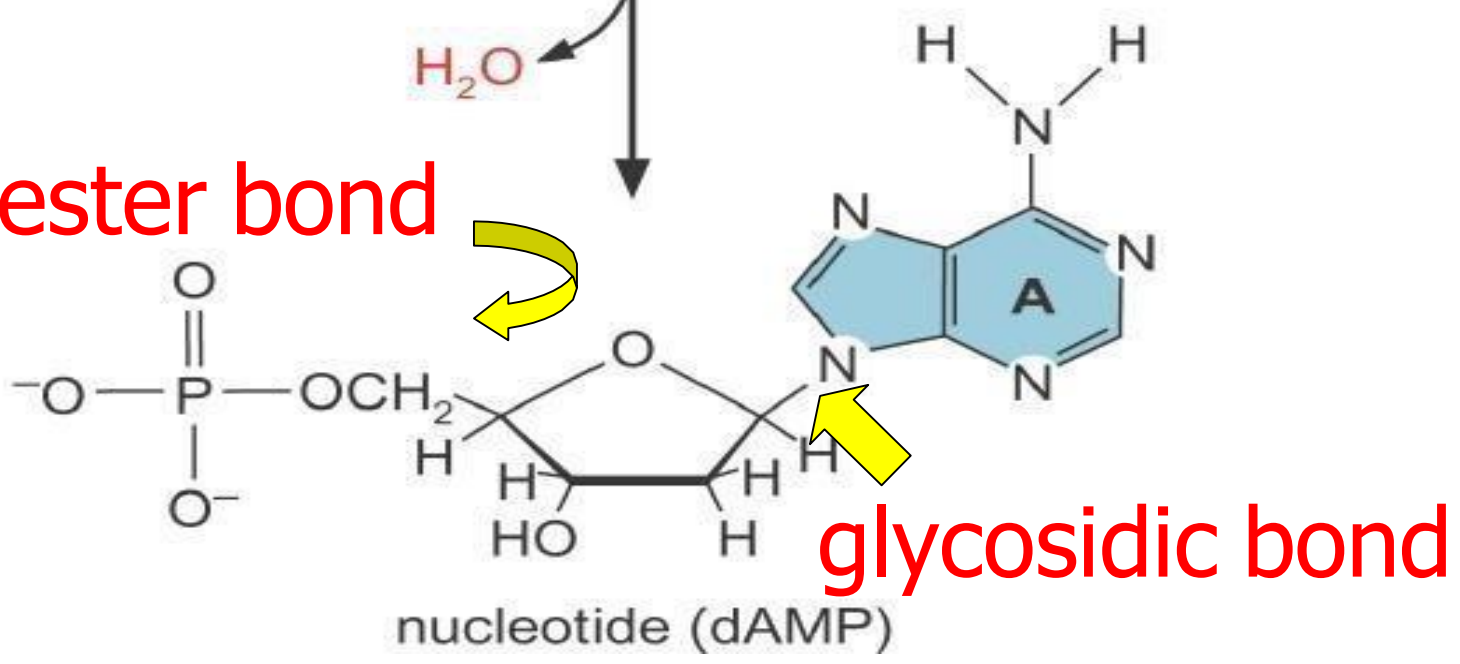
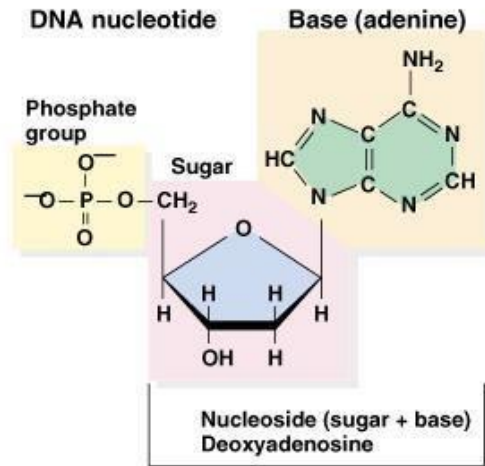
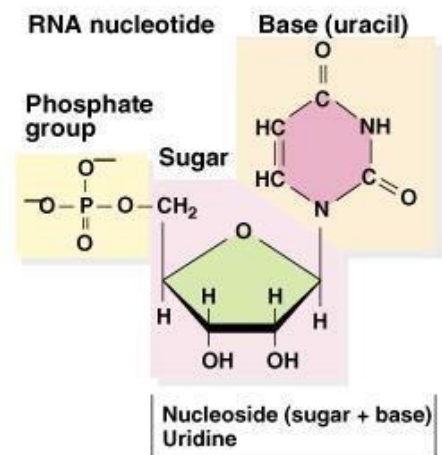

Fig. 2.11 Chemical structures of DNA and RNA

a) DNA and RNA nucleotides



Nucleotide (sugar + base + phosphate group)
Deoxyadenosine 5' — monophosphate



Nucleotide (sugar + base + phosphate group)
Uridine 5' — monophosphate or uridylic acid

b) DNA polynucleotide chain

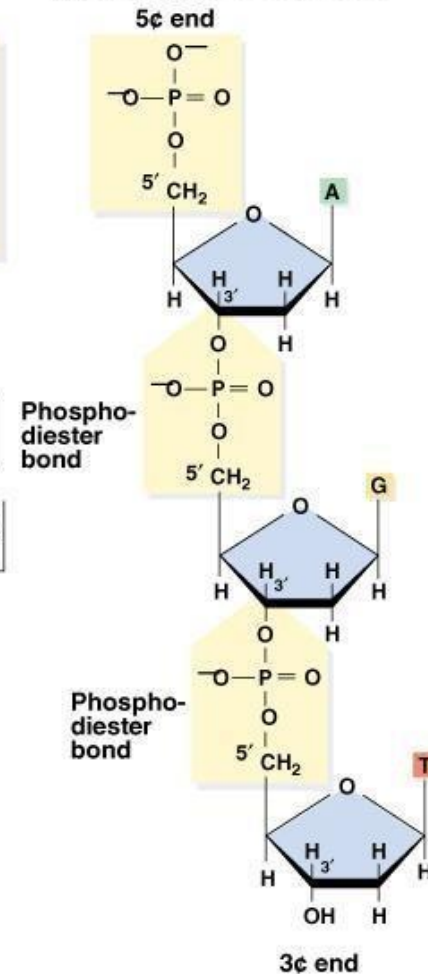

Phosphodiester linkages: repeating, sugar-phosphate **backbone** of the polynucleotide chain

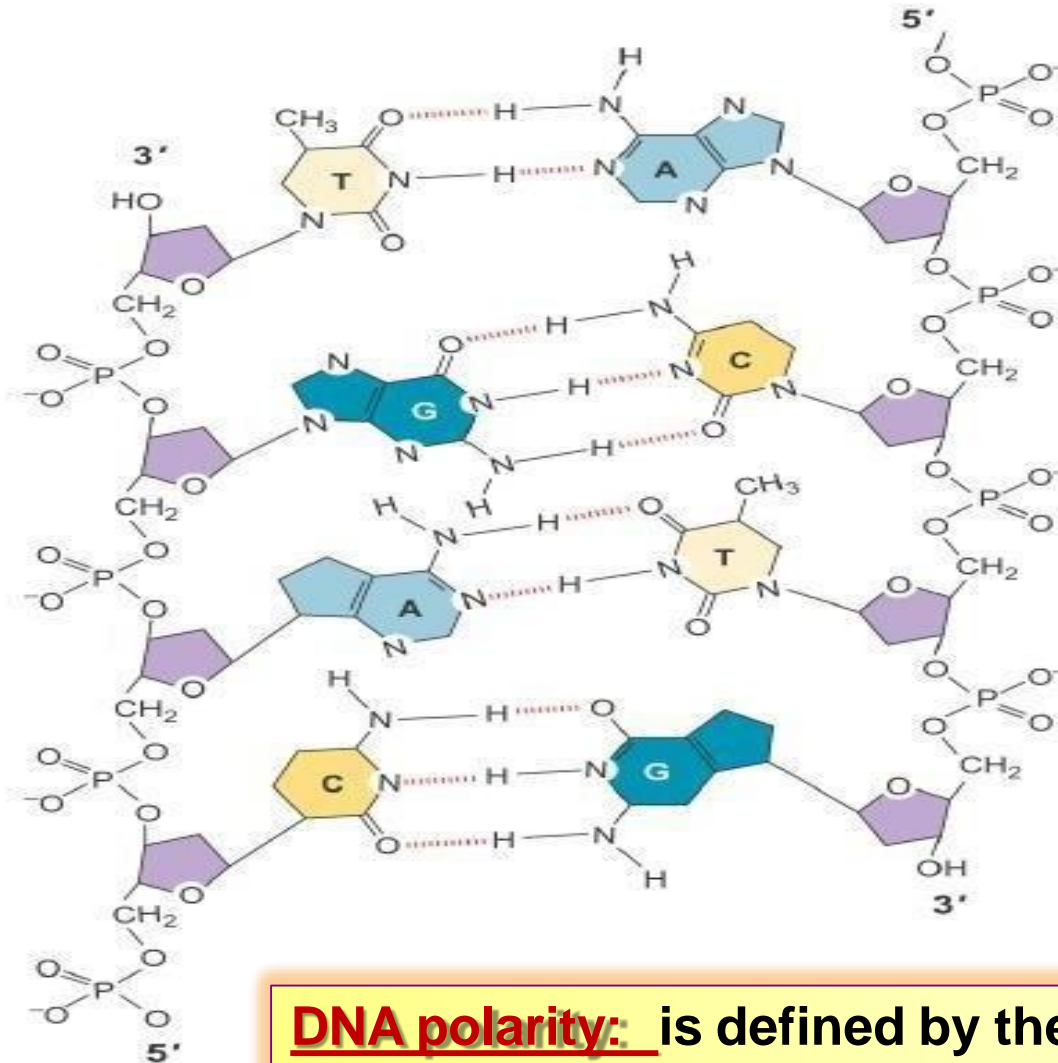

DNA polarity: is defined by the asymmetry of the nucleotides and the way they are joined.

The Double Helix – Discovery of DNA Model

X-Ray Diffraction of DNA by Rosalind Franklin and Maurice Wilkins

Base composition experiments by E. Chargaff

Double helical model by Watson and Crick

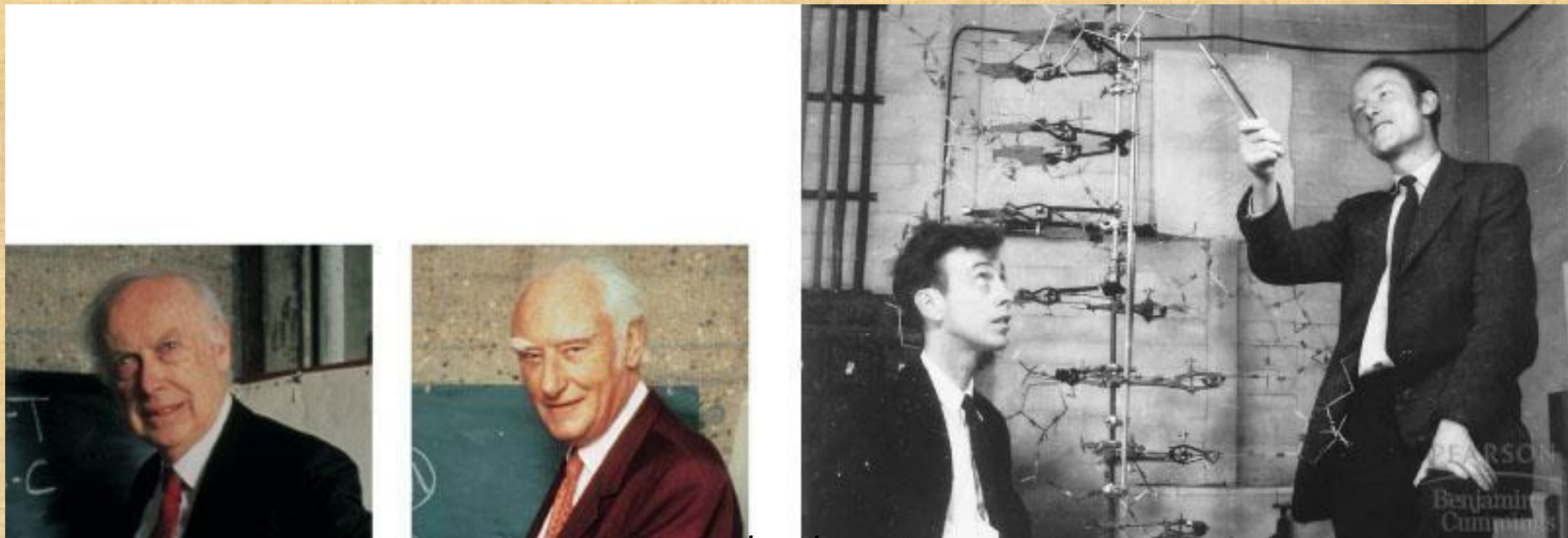

The Discovery of the DNA Double Helix

1. James Watson and Francis Crick published the famous double-helix structure in 1953. When they began their work, it was known that DNA is composed of nucleotides, but how the nucleotides are assembled into nucleic acid was unknown. Two additional sources of data assisted Watson and Crick with their model:
 - a. **Erwin Chargaff's ratios obtained for DNA derived from a variety of sources showed that the amount of purine always equals the amount of pyrimidine, and further, that the amount of G equals C, and the amount of A equals T.**
 - b. **Rosalind Franklin's X ray diffraction images of DNA showed a helical structure with regularities at 0.34 nm and 3.4 nm along the axis of the molecule (Figure 8.9).**
 - c. **3'-5' phosphodiester bonds regularly linked together the nucleotides of DNA – Alexander Todd laboratory in 1952**

Rosalind Franklin
at King's College
London, 1953

EXPERIMENT

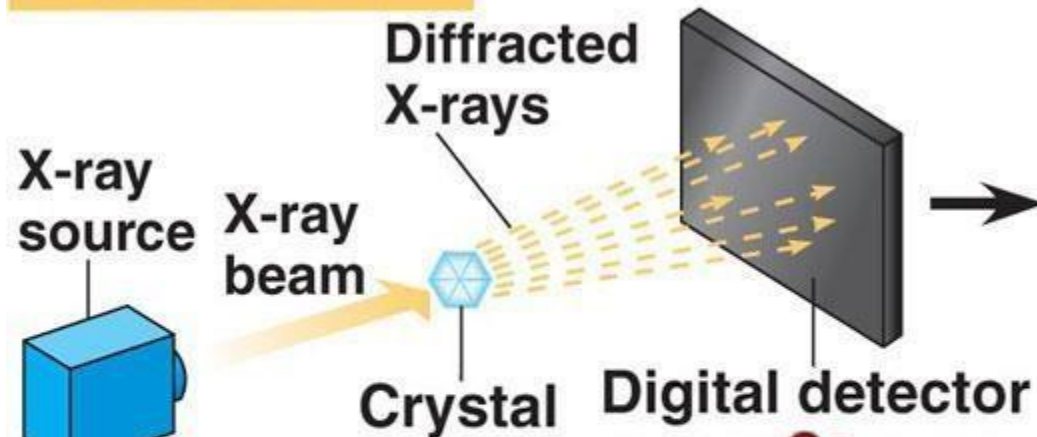

RESULTS

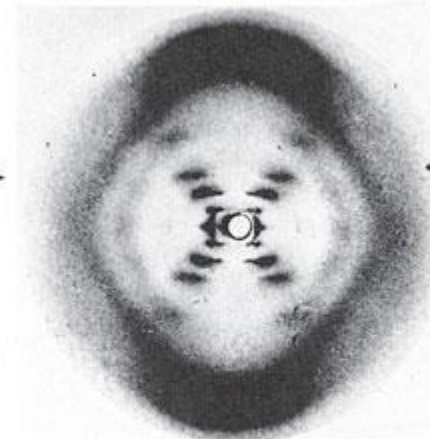
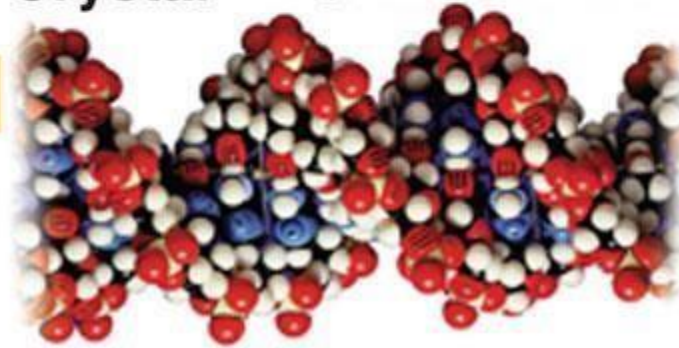

Franklin's X-ray diffraction
photograph of DNA



- The helical form is indicated by the crossways pattern of X-ray reflections.
- Very heavy black regions at the top and bottom – 3.4 Å thick purine and pyrimidine bases regularly stacked next to each other perpendicular to the helical axis.

DNA (1) was helical, (2) was likely a double helix with anti-parallel strands, (3) had the phosphate backbone on the outside, Diameter of helix – 20 Å and Length of each helical turn – 34 Å

Biochemist Erwin Chargaff in 1949 used paper [chromatography](#) to compile data on the base compositions in DNA of many species. For each species, the amount of A is proportional to the amount of T, and the amount of G is proportional to the amount of C. This also reflects a 1:1 ratio of purine (A + G) and pyrimidine (C + T) [bases](#)

DNA BASE COMPOSITION DATA

(a) Chargaff's data*

Molar proportions^a

Organism's/Source	1	2	3	4
	A	T	G	C
Ox thymus	26	25	21	16
Ox spleen	25	24	20	15
Yeast	24	25	14	13
Avian tubercle bacilli	12	11	28	26
Human sperm	29	31	18	18

(c) G + C content in several organisms

Organism	%G + C
Phage T2	36.0
<i>Drosophila</i>	45.0
Maize	49.1
<i>Euglena</i>	53.5
<i>Neurospora</i>	53.7

(b) Base compositions of DNAs from various sources

Base composition

Base ratio

A + T/G + C ratio

Source	1	2	3	4	5	6	7	8
	A	T	G	C	A/T	G/C	(A + G)/(C + T)	(A + T)/(C + G)
Human	30.9	29.4	19.9	19.8	1.05	1.00	1.04	1.52
Sea urchin	32.8	32.1	17.7	17.3	1.02	1.02	1.02	1.58
<i>E. coli</i>	24.7	23.6	26.0	25.7	1.04	1.01	1.03	0.93
<i>Sarcina lutea</i>	13.4	12.4	37.1	37.1	1.08	1.00	1.04	0.35
T7 bacteriophage	26.0	26.0	24.0	24.0	1.00	1.00	1.00	1.08

* Source: From Chargaff, 1950.

^aMoles of nitrogenous constituent per mole of P. (Often, the reciprocal is given in percent.)

Structure and Gene Replication

- Data suggest an α helical structure for DNA
- The double-stranded helix suggested a model of DNA replication in which each strand could serve as template for a new, daughter, strand

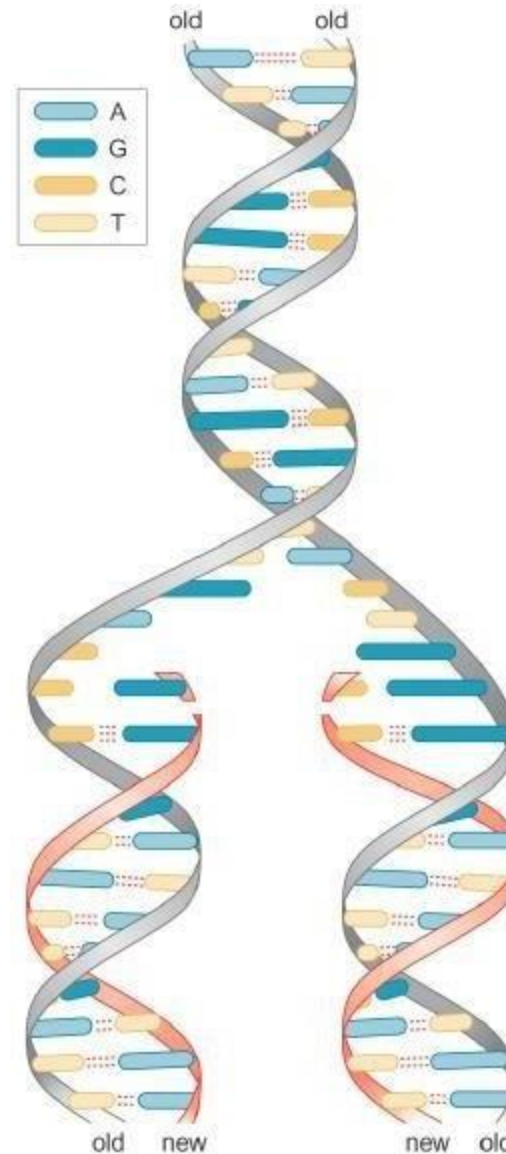

The nucleotides of DNA/RNA

- Each carbon atom in the pentose sugar is assigned a number with a prime sign (').
- Ribonucleic acids (RNA) contain ribose, a 5-carbon sugar.
- Deoxyribonucleic acids (DNA) contain deoxyribose, which has a hydrogen atom at the 2' carbon rather than a hydroxyl group.
- A ribose or deoxyribose sugar with a purine or pyrimidine base attached to the 1' carbon is called a nucleoside.

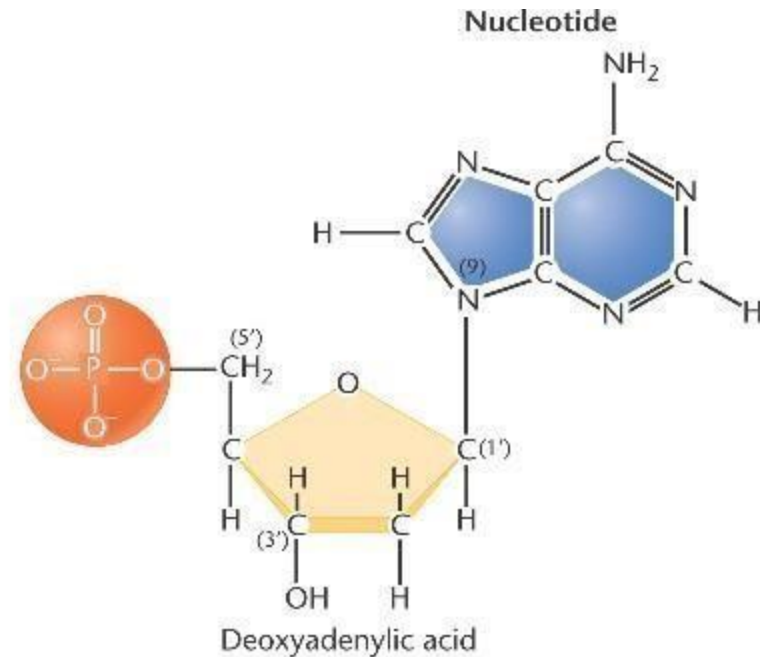
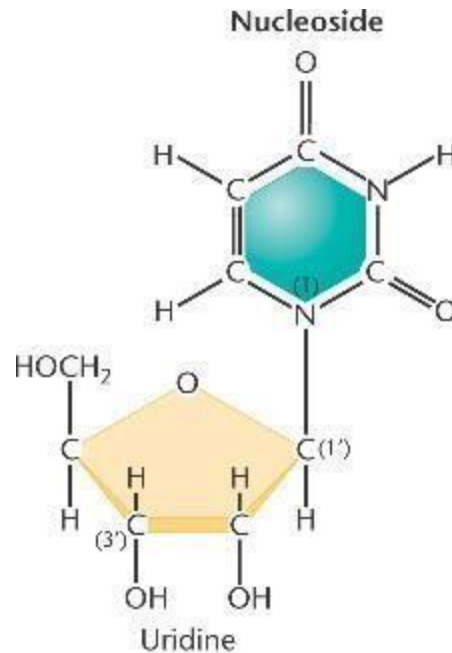

Ribonucleosides	Ribonucleotides
Adenosine Cytidine Guanosine Uridine	Adenylic acid Cytidylic acid Guanylic acid Uridylic acid
Deoxyribonucleosides	Deoxyribonucleotides
Deoxyadenosine Deoxycytidine Deoxyguanosine Deoxythymidine	Deoxyadenylic acid Deoxycytidylic acid Deoxyguanylic acid Deoxythymidylic acid

A portion of DNA polynucleotide chain, showing 3'-5' phosphodiester linkages that connect nucleotides

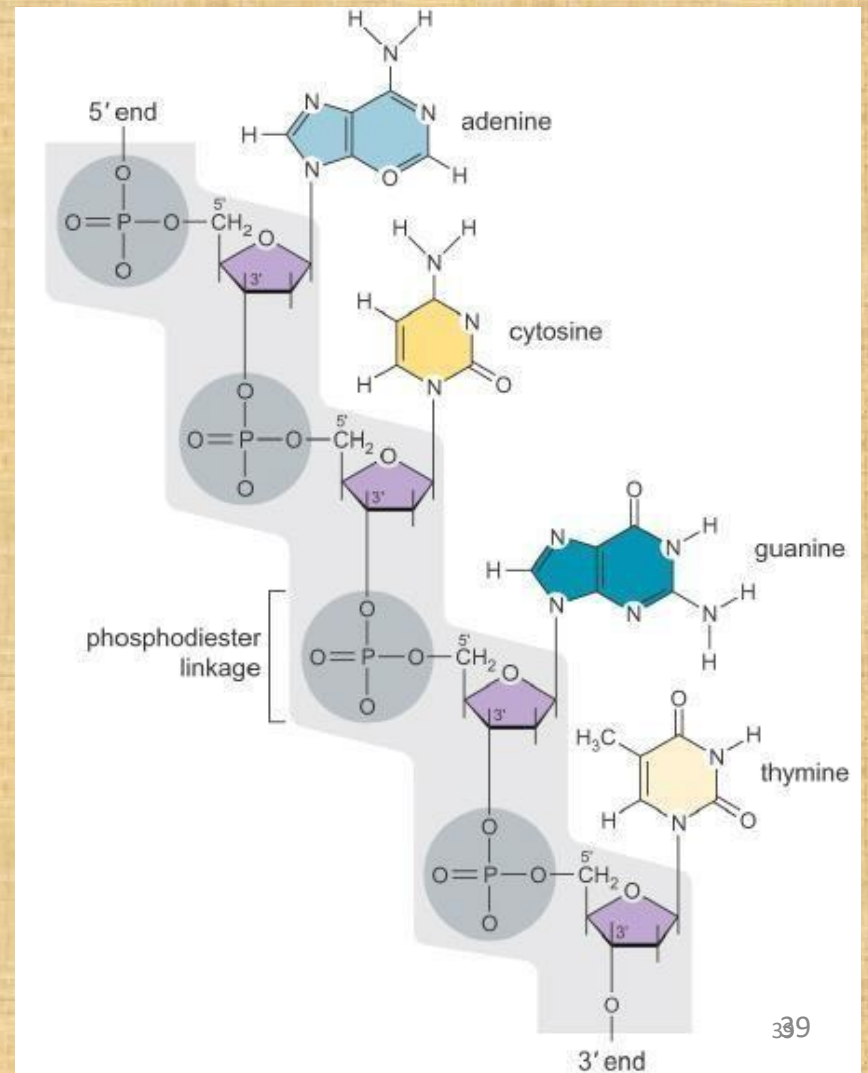
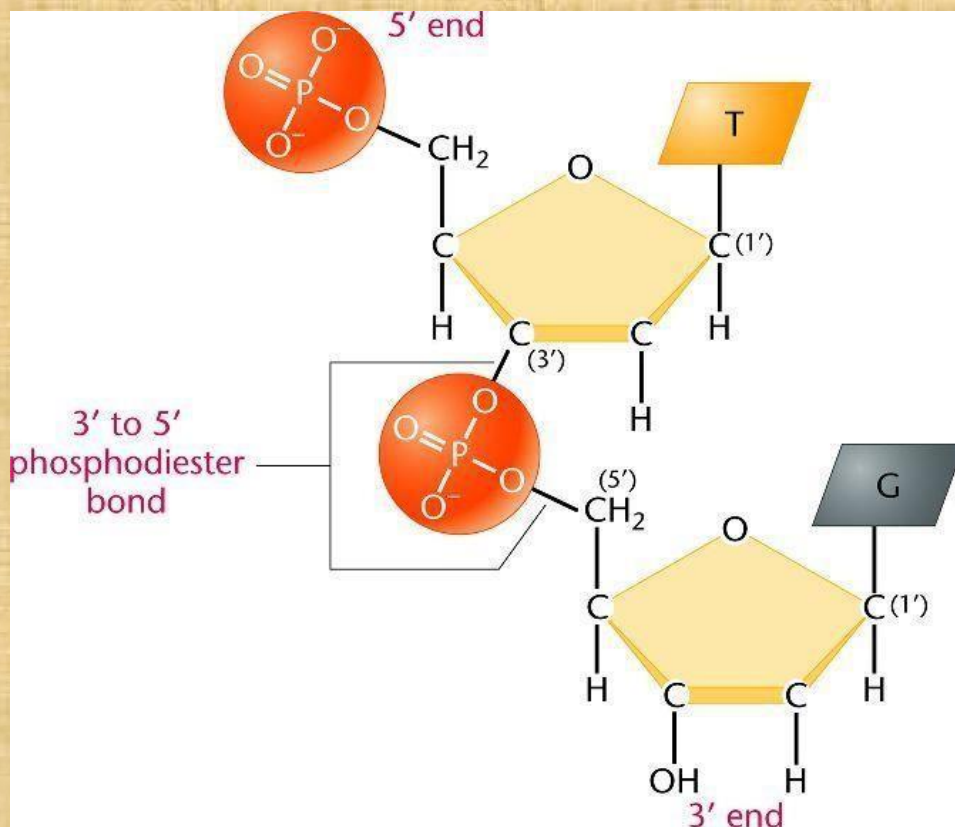

The 2 DNA strands run in opposite (antiparallel) directions; one in the 3' - 5' direction, the other 5' - 3'. The A-T and G-C base pairing provides complementarity of the two strands. Thus, DNA follows these base-pairing rules: A always pairs with T, and G always pairs with C.

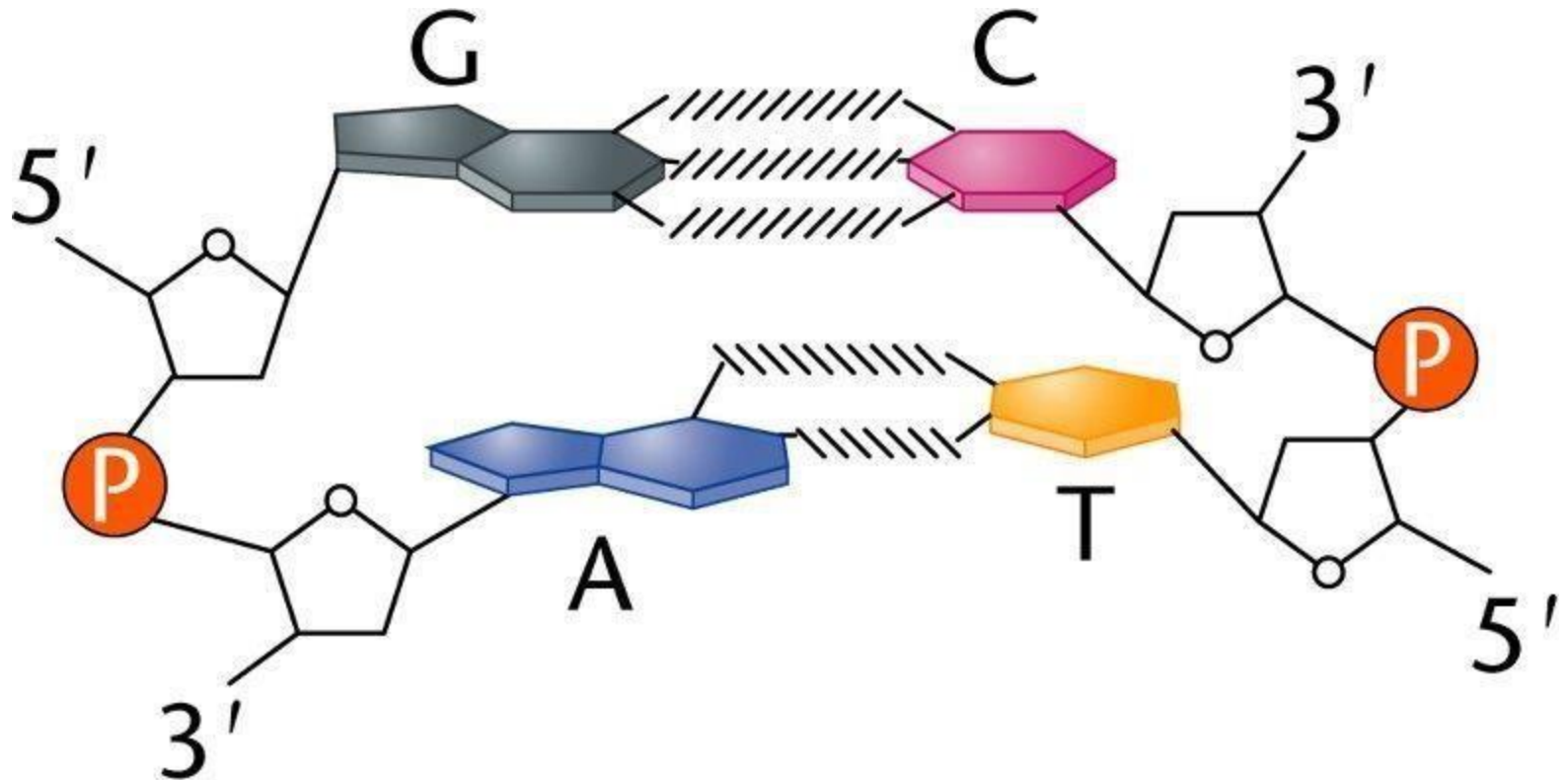

The Discovery of the DNA Double Helix

2. Watson and Crick's three-dimensional main features:

- It is two polynucleotide chains forming a right-handed helix.
- The two chains are antiparallel.
- The sugar-phosphate backbone and the bases are on the inside of the helix, with the bases on the long axis like the steps of a spiral staircase.

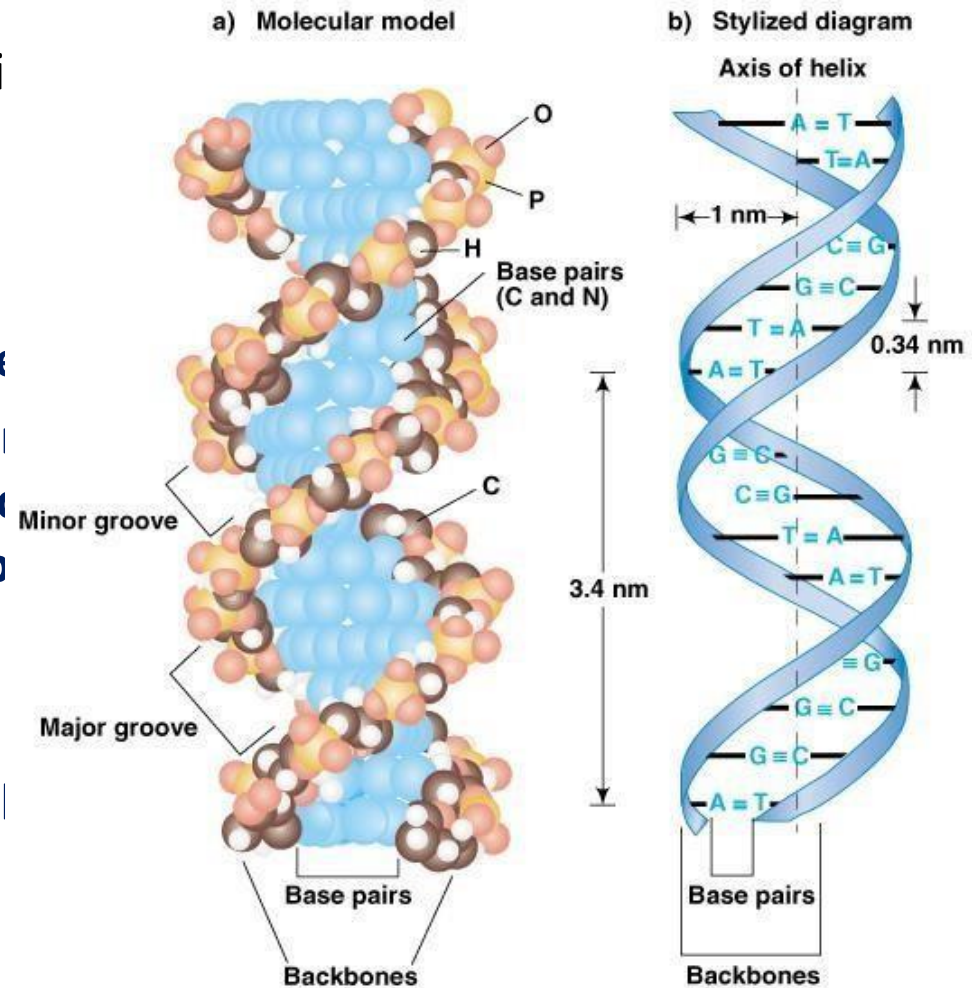

DNA is usually a right-handed double helix.

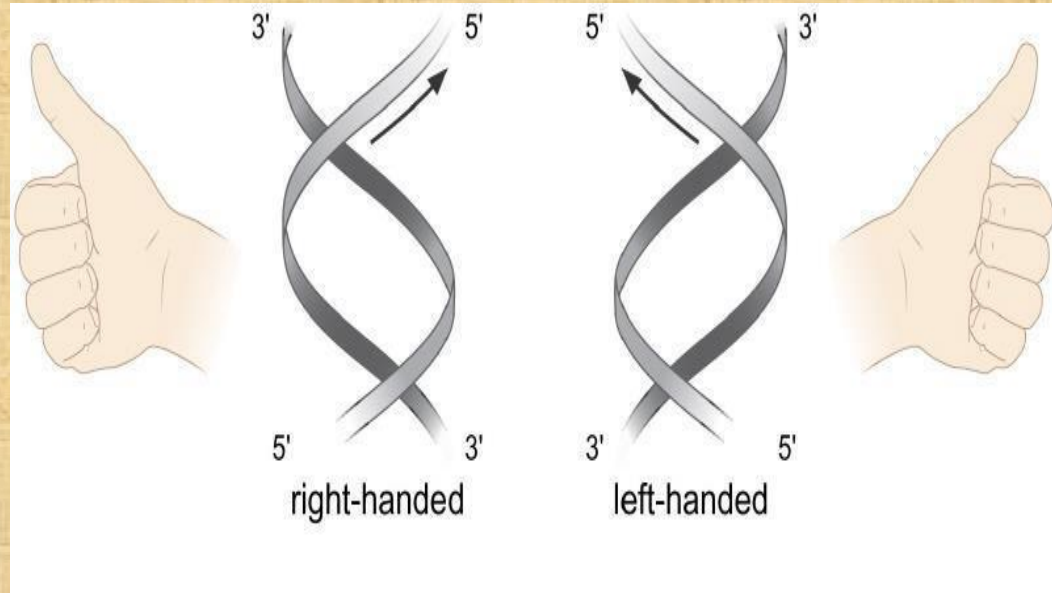
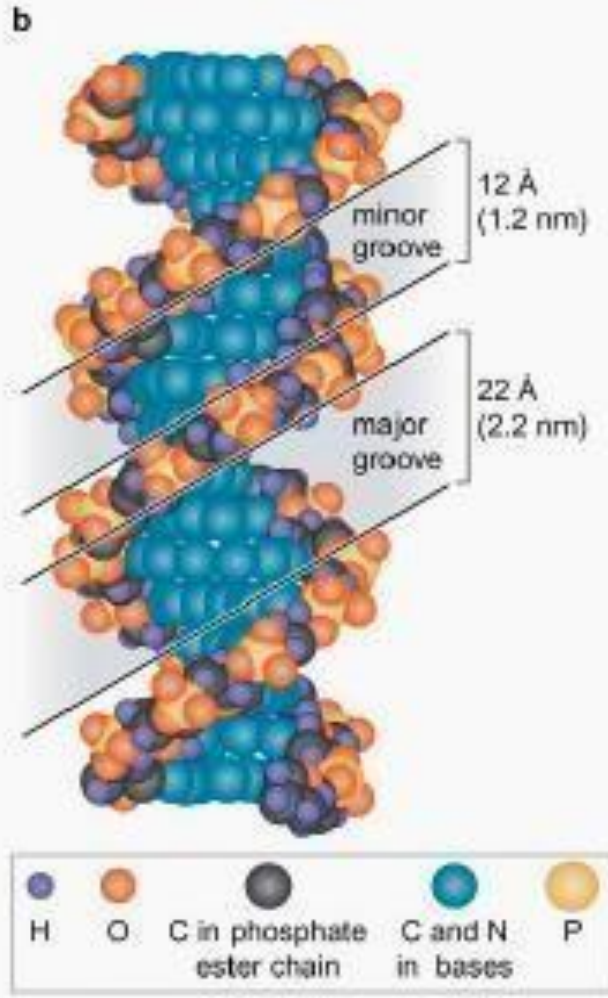

d. The bases of the two strands are held together by hydrogen bonds between complementary bases (two for A-T pairs and three for G-C pairs). Individual H-bonds are relatively weak and so the strands can be separated (by heating, for example). Complementary base pairing means that the sequence of one strand dictates the sequence of the other strand.

a) Adenine-thymine base
(Double hydrogen bond)

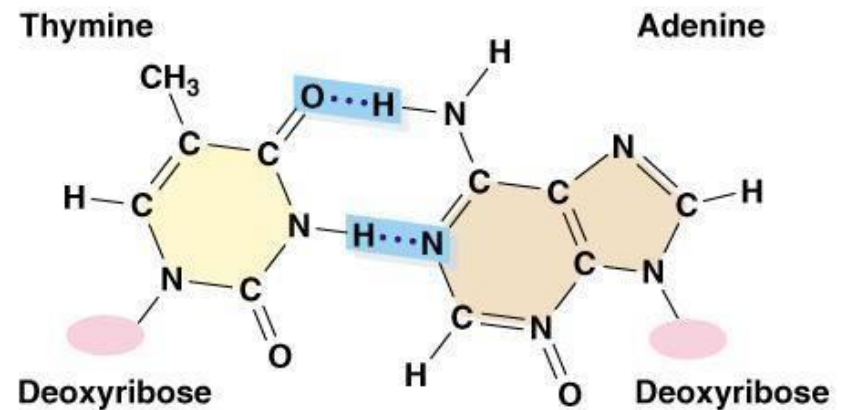

b) Guanine-cytosine base
(Triple hydrogen bond)

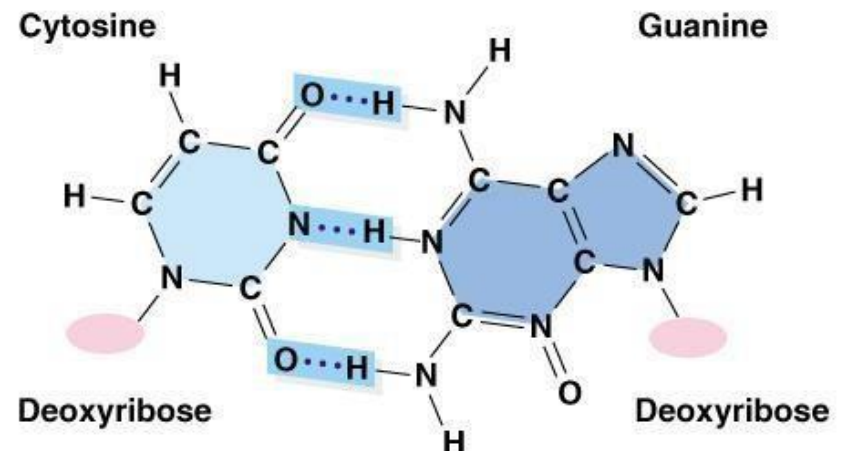

e. The base pairs are 0.34 nm apart, and one full turn of the DNA helix takes 3.4 nm, so there are 10 bp in a complete turn. The diameter of a dsDNA helix is 2 nm.

f. Because of the way the bases H-bond with each other, the opposite sugar-phosphate backbones are not equally spaced, resulting in a major and minor groove. This feature of DNA structure is important for protein binding.

3. The 1962 Nobel Prize in Physiology or Medicine was awarded to Francis Crick, James Watson and Maurice Wilkins (the head of the lab in which Franklin worked). Franklin had already died, and so was not eligible.

Different DNA Structures

X ray diffraction studies show that DNA can exist in different forms.

- a. **A-DNA is the dehydrated form, and so it is not usually found in cells. It is a right-handed helix with 10.9 bp/turn, with the bases inclined 13° from the helix axis. A-DNA has a deep and narrow major groove, and a wide and shallow minor groove.**
- b. **B-DNA is the hydrated form of DNA, the kind normally found in cells. It is also a right-handed helix, with only 10.0 bp/turn, and the bases inclined only 2° from the helix axis. B-DNA has a wide major groove and a narrow minor groove, and its major and minor grooves are of about the same depth.**
- c. **Z-DNA is a left-handed helix with a zigzag sugar-phosphate backbone that gives it its name. It has 12.0 bp/turn, with the bases inclined 8.8° from the helix axis. Z-DNA has a deep minor groove, and a very shallow major groove. Its existence in living cells has not been proven.**

a B DNA

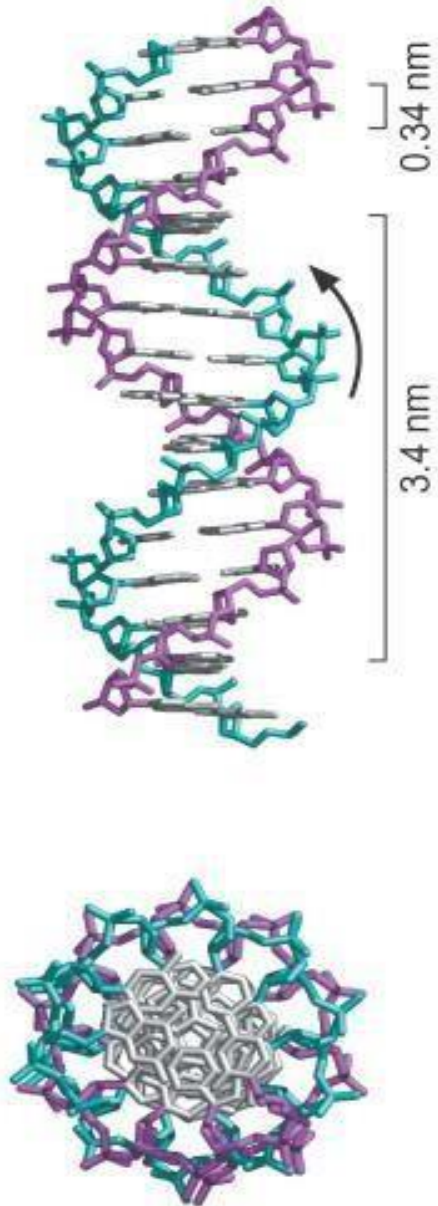

b A DNA

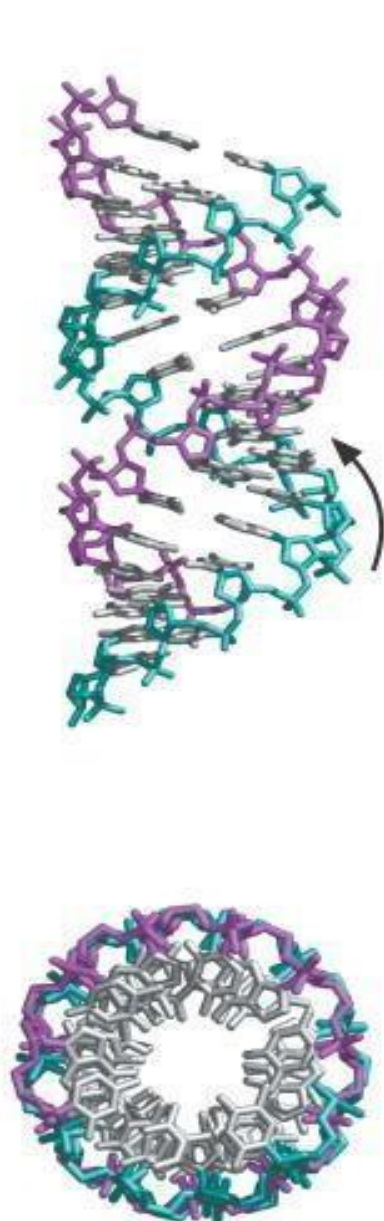

c Z DNA

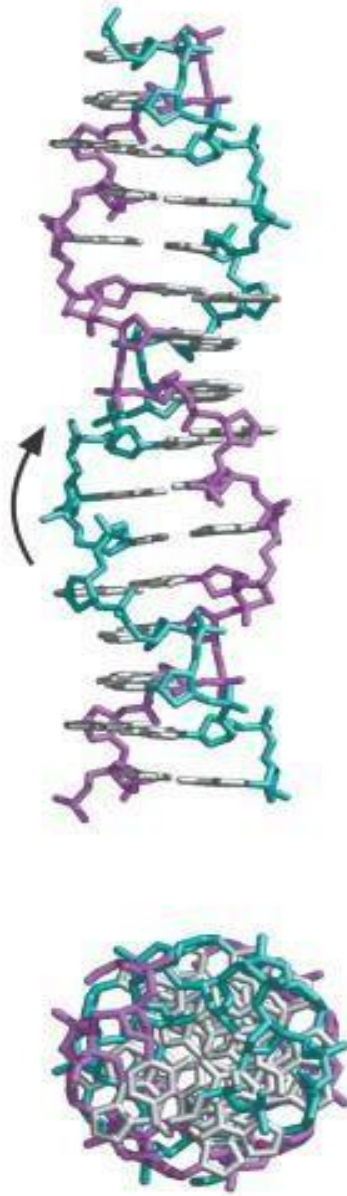

TABLE 6-2 A Comparison of the Structural Properties of A, B, and Z DNAs as Derived from Single-Crystal X-Ray Analysis

	Helix Type		
	A	B	Z
Overall proportions	Short and broad	Longer and thinner	Elongated and slim
Rise per base pair	2.3 Å	3.32 Å	3.8 Å
Helix-packing diameter	25.5 Å	23.7 Å	18.4 Å
Helix rotation sense	Right-handed	Right-handed	Left-handed
Base pairs per helix repeat	1	1	2
Base pairs per turn of helix	~11	~10	12
Rotation per base pair	33.6°	35.9°	-60° per 2 bp
Pitch per turn of helix	24.6 Å	33.2 Å	45.6 Å
Tilt of base normals to helix axis	+19°	-1.2°	-9°
Base-pair mean propeller twist	+18°	+16°	~0°
Helix axis location	Major groove	Through base pairs	Minor groove
Major-groove proportions	Extremely narrow but very deep	Wide and of intermediate depth	Flattened out on helix surface
Minor-groove proportions	Very broad but shallow	Narrow and of intermediate depth	Extremely narrow but very deep
Glycosyl-bond conformation	<i>anti</i>	<i>anti</i>	<i>anti</i> at C, <i>syn</i> at G

Source: Adapted from Dickerson R. E. et al. 1982. *CSHSQB* 47: 14. Copyright © 1982 Cold Spring Harbor Laboratory Press. Used with permission.