

Natural Gas and the Liquefaction Process







- Cameron LNG 2
- Liquefied Natural Gas 4
- LNG Safety 5
- Environmental Safety 6
- Liquid Properties 7
- Vapor Properties 8
- The Liquefaction Process 9
- LNG Storage 13
- Transportation 15
- Receiving Terminals 16
- The Illustrated Gas Chain 17

Cameron LNG

A small local footprint with global impact

Cameron LNG exists to liquefy natural gas for our customers. Our work is to do this consistently, to do it well and to do it safely over time. We work with a sense of responsibility to our employees, our communities, our stakeholders and the environment in which we operate.

Cameron LNG is headquartered in Houston and our liquefaction facility is in southwest Louisiana. The facility is cradled by the Calcasieu River in the midst of peaceful marsh and swamp land just 18 miles north of the Gulf of Mexico.

Our name is derived from Cameron Parish, which is known for its many lakes, wildlife refuges and natural beauty. Cameron Parish is also the largest of Louisiana's parishes with 1,313 square miles of land and 619 square miles of water inhabited by reptiles of all sorts, fresh and saltwater wildlife, over 400 bird species, sportsmen of all types and local families. Cameron LNG has made a commitment to safeguard the environment in which we operate, and we hold that responsibility as sacrosanct.

Cameron LNG's partners are Sempra LNG & Midstream, Mitsui & Co., Mitsubishi Corporation, ENGIE, and NYK line. Together, these companies represent extensive LNG and market experience.

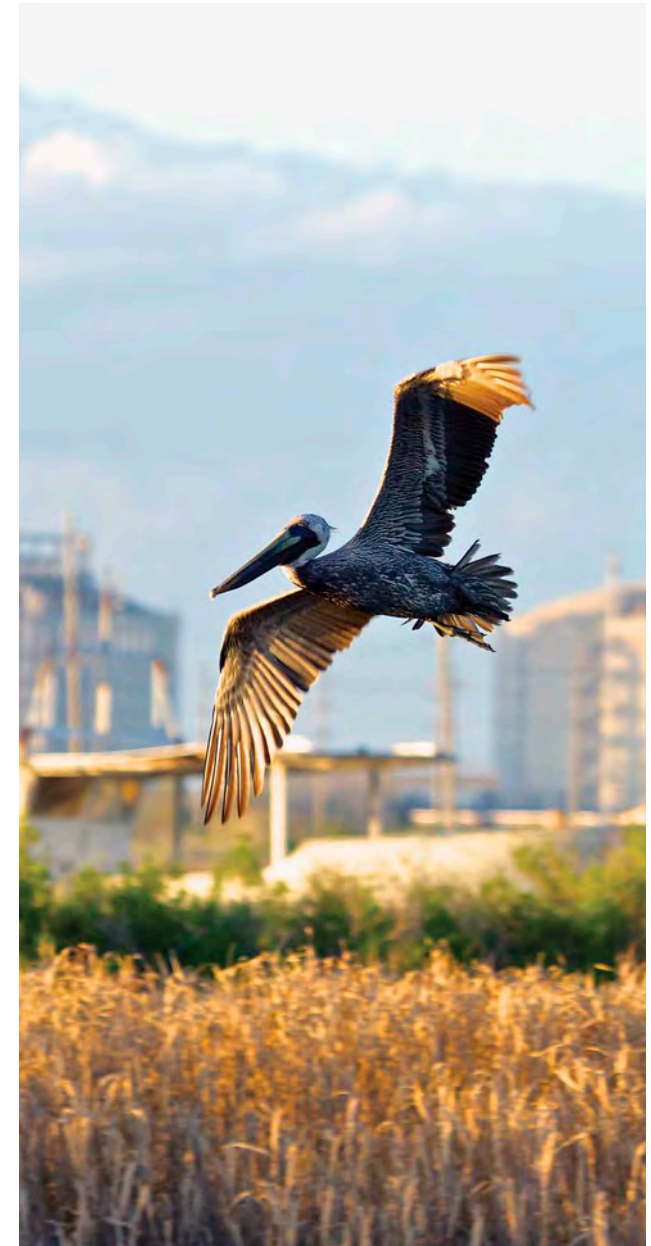



Cameron LNG

Our two-berth, three tank facility became part of the community and commercially operated in 2009. In 2014, the partners committed an estimated \$10 billion to construct a liquefaction facility. Once fully operational, we will be able to liquefy domestically-produced natural gas for export, import liquefied natural gas (LNG) and regasify it for delivery to domestic markets and re-export foreign-sourced LNG. Our three-train project has been granted approval to export an annual 14.95 Mtpa, which will have many benefits, both locally and globally. Locally, new jobs and economic prosperity have been created in the region. Globally, we will supply America's trading partners with access to stable supplies of liquefied natural gas.

Historically, you can find references to natural gas dating back to 1,000 B.C.. With advances in technology the U.S. currently has an estimated 100-year supply of shale gas. The process of liquefying natural gas is comparatively new and was only discovered in 1820. The first LNG plant was built in 1912 and LNG shipping began around 1959. Still, many myths and misconceptions persist in the general public about LNG. We assembled this book in hope of dispelling some myths, correcting others and enlightening all. We hope you enjoy the book and gain a more complete understanding of LNG.





What is LNG?

Liquefied natural gas is gas that has been cooled to -260°F (-160°C) and converts to a liquid state. When natural gas is in a liquid form, it takes up approximately $1/600^{\text{th}}$ of the space it would as a vapor, making transportation much more efficient and economical.

NATURAL GAS AND LNG

LNG is mostly methane plus a small percent of ethane, propane and butane, and trace amounts of nitrogen.

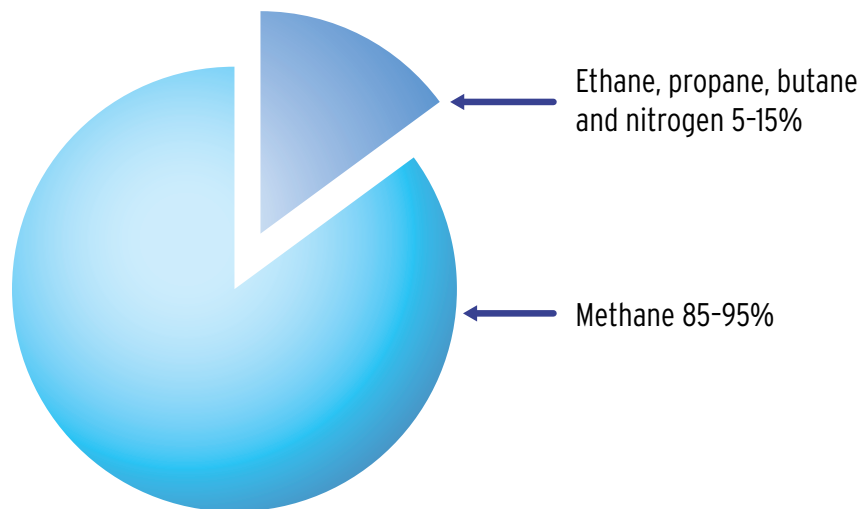

When natural gas is liquefied, there is a 600% reduction in volume.

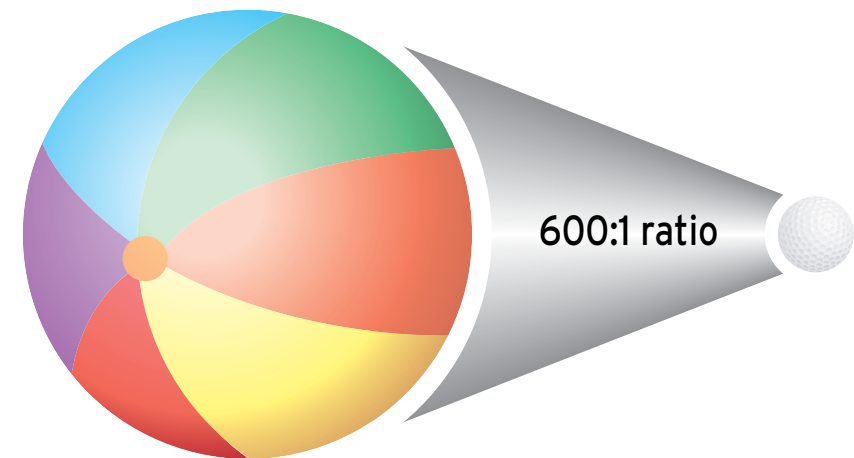

The same amount of natural gas that would fill a beach ball...

...can fit in a golf ball when liquefied.



LNG SAFETY

Is it safe?

LNG is very safe to transport, and the industry's safety record is exemplary. For over 50 years, LNG has been safely transported around the world in tankers. LNG is an odorless, non-toxic, non-corrosive liquid and leaves no residue after it evaporates. LNG will not ignite until it becomes a vapor, and even then the vapor won't ignite until it mixes with air and becomes extremely diluted (5- 15% vaporized gas-to-air ratio).

Below 5% there is too little gas in the air to burn; above 15%, there is not enough oxygen. Tests conducted by the Sandia National Laboratories for the U.S. Department of Energy demonstrate that unconfined LNG vapor clouds do not detonate, they only burn.

LNG FLAMMABILITY

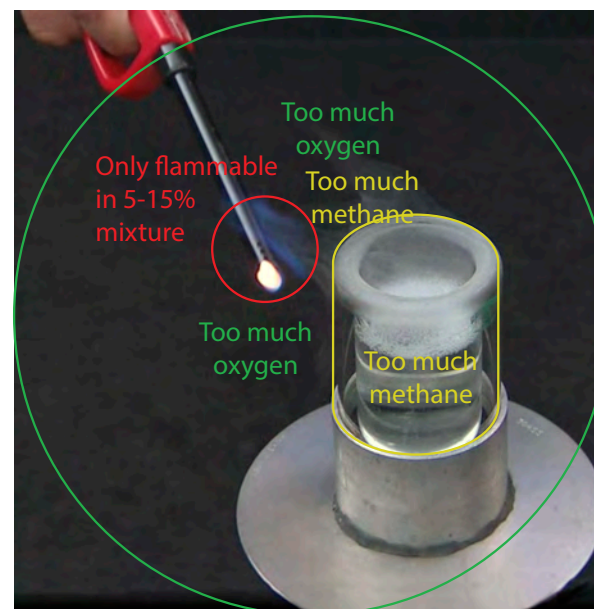
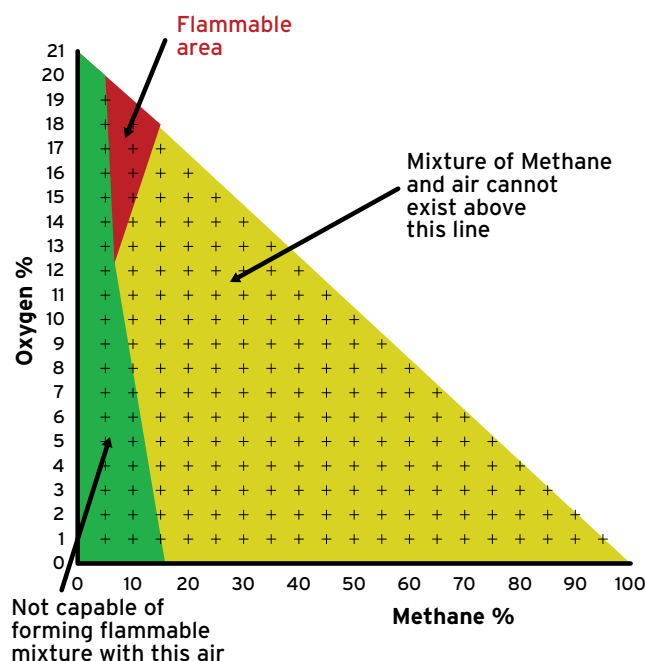

Methane is only flammable when mixed with oxygen in a 5-15% methane-to-oxygen ratio



What if there is a release?

LNG is safely transported by sea because every precaution is taken to mitigate the possibility of a release. If there were a release, vaporizing LNG is not soluble in water and any liquid released on land or in the ocean would quickly evaporate. There is no possibility for land or water contamination. LNG is non-toxic and it does not chemically react unless it is ignited.





LIQUID PROPERTIES

LNG as a liquid

- Looks like mineral water
- Stored as a liquid in well-insulated tanks at near atmospheric pressure
- Does not absorb into the ground
- Floats on water then vaporizes (all that's left is ice)
- Large spills on water may produce rapid phase transition (non-combustion explosion)

LNG poured
into cup
begins to
vaporize

Water
freezes
on top

Does not
break glass

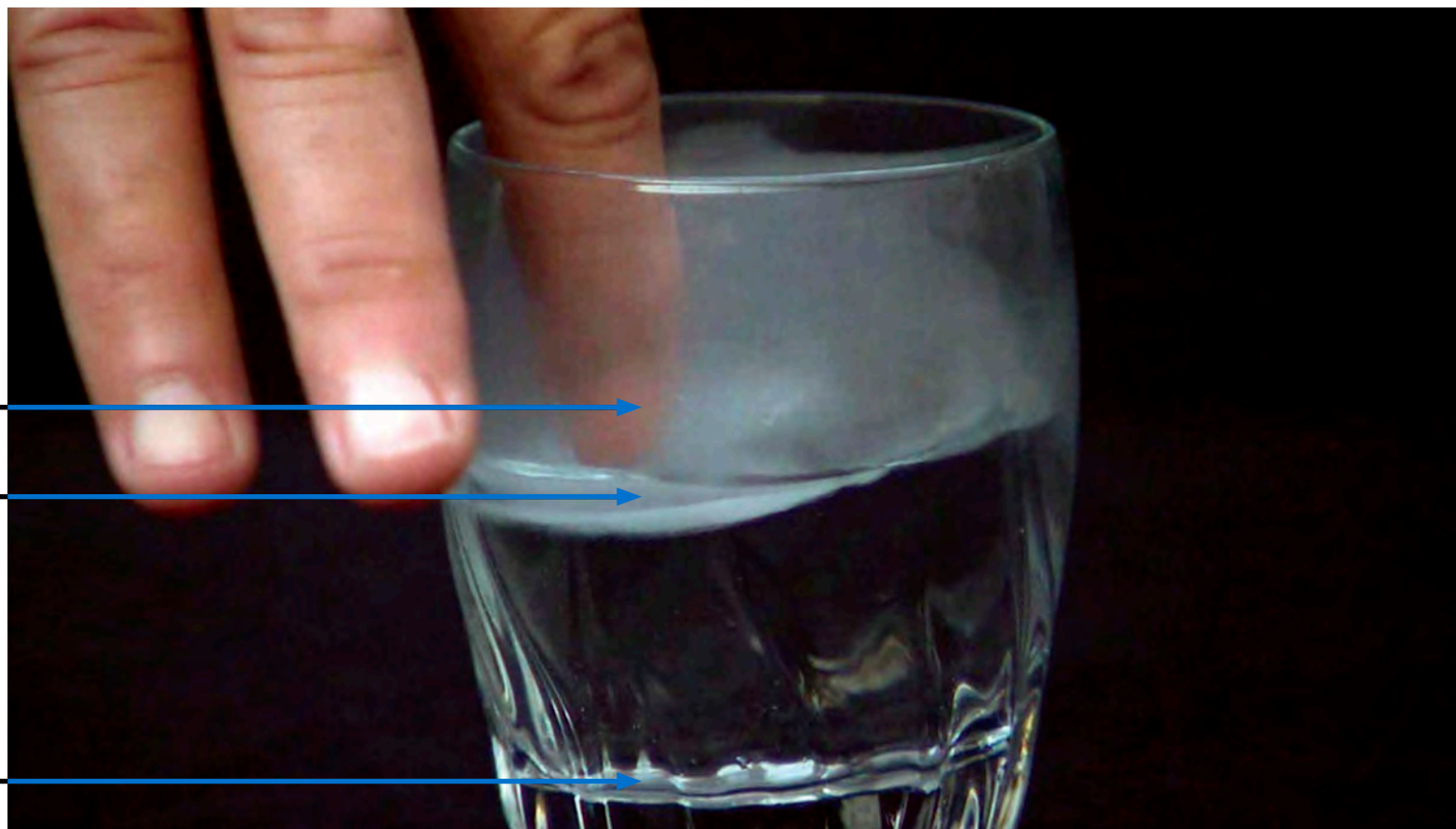



LNG as a vapor

- Looks like fog
- Lighter than air, rises and disperses
- Leaves no residue on land or water
- Cloud flammable only when gas is within 5-15% range
- Non-explosive unless ignited in confined space





THE LIQUEFACTION PROCESS



How is natural gas liquefied?

Natural gas is converted to a liquid in a liquefaction plant, or “train”. An LNG train performs three main processes:

1. Pretreatment

Dust and slug (water and condensate) is removed along with hydrogen sulfide (H_2S) and mercury (Hg). These pollutants can cause corrosion and freezing problems, especially in aluminum heat exchangers.

2. Acid Gas Removal and Dehydration

Carbon dioxide (CO_2) is absorbed and removed from natural gas with an amine absorber (acid gas removal or AGR) and an adsorbent is used to remove water. These impure substances are removed so that ice will not form during the subsequent liquefaction process.

3. Heavy Hydrocarbon Separation and Liquefaction

Heavy hydrocarbons (C_5+) are removed by fractionation before liquefaction. As shown in the liquefaction process schematic, natural gas is pre-cooled to about $-31^\circ F$ ($-35^\circ C$) by propane.

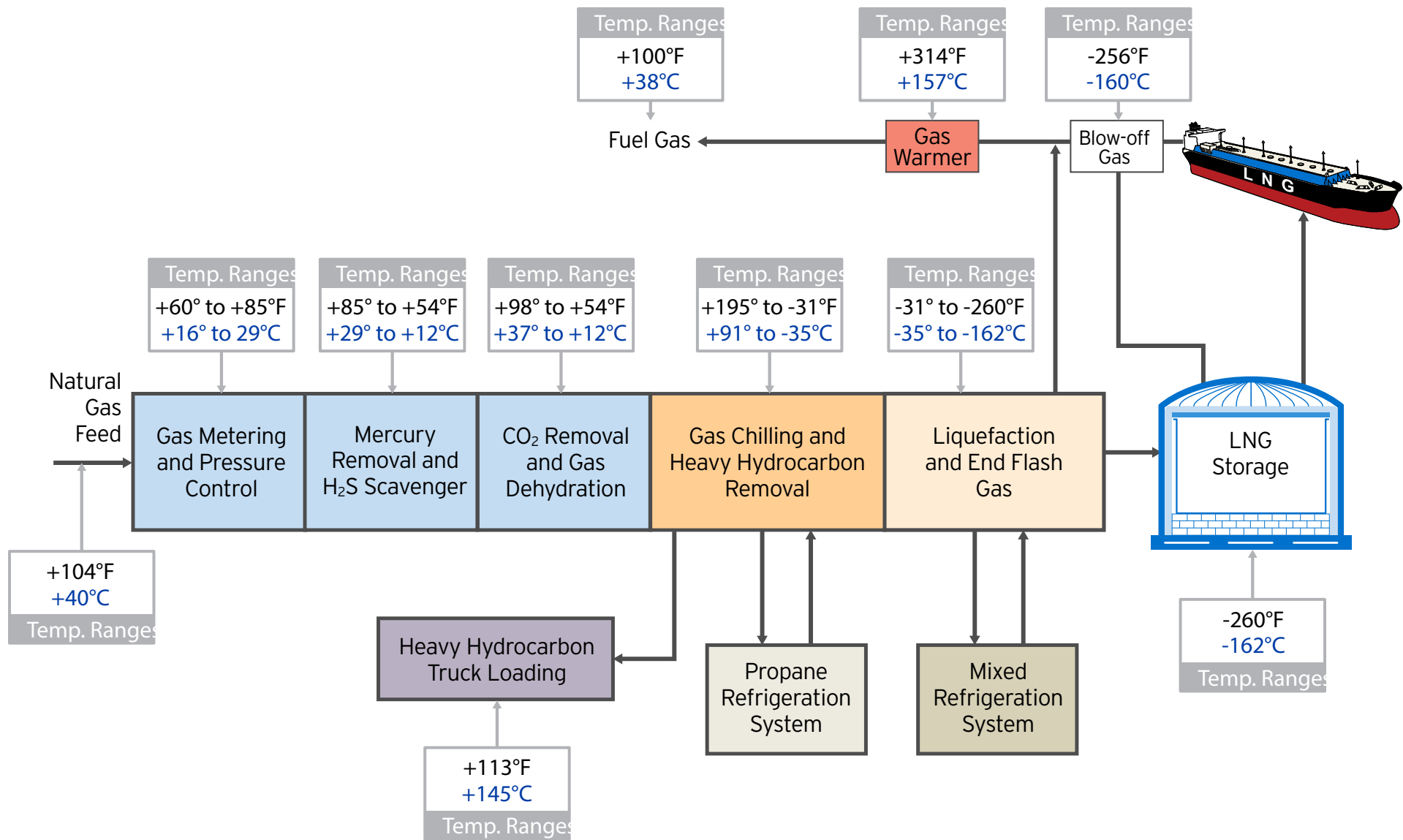



THE LIQUEFACTION PROCESS *(CONTINUED)*

After pre-cooling, natural gas moves through a tube circuit in the main cryogenic heat exchanger (MCHE) where it is liquefied and sub-cooled to between -238°F (-150°C) to -260°F (-162°C) by mixed refrigerant (MR). The MR is also pre-cooled and then separated in a high pressure separator. The vapor and liquid streams pass through separate tube circuits in the MCHE where they are further cooled, liquefied, and sub-cooled.

The two sub-cooled streams are let down in pressure, further reducing their temperatures. As the mixed refrigerant vaporizes and flows downward on the shell side of the MCHE, it provides refrigeration for liquefying and sub-cooling the natural gas. The LNG end flash at the outlet of the MCHE and in the receiving LNG storage tank generates flash gas and boil-off gas to make up the fuel gas needed mainly by the propane and MR gas turbine driven compression cycles.



Train 1 - April 19, 2017

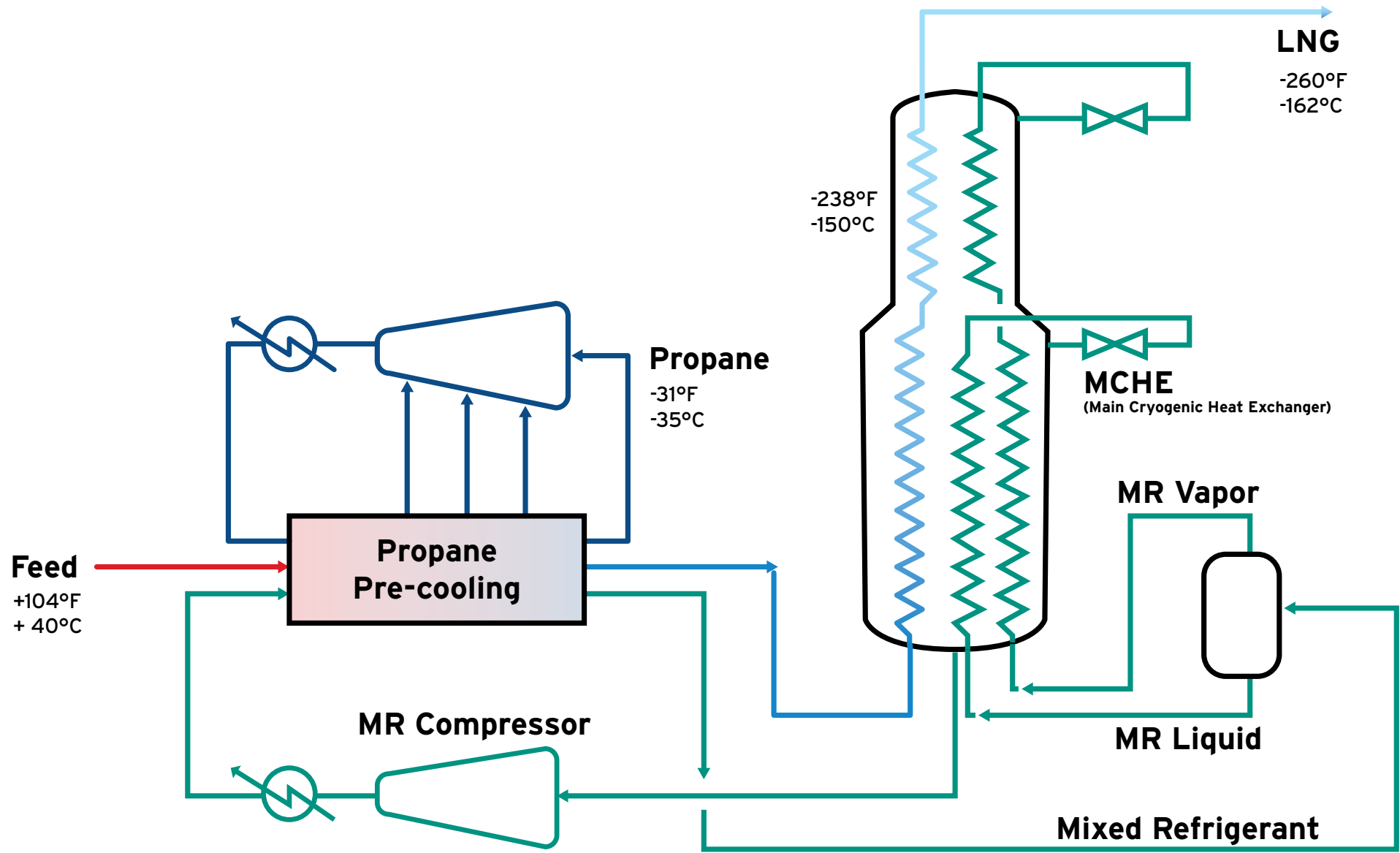



LNG STORAGE

How is LNG stored?

LNG is stored in full-containment tanks, which typically have a capacity of 160,000 m³. LNG tank pressures are kept at just above one atmosphere.

Full-containment systems have two tanks, an inner one for the product and an outer one providing security against leakage.

The inner shell is made of a special nickel alloy designed to resist low temperatures, and the outer shell is pre-stressed concrete with a reinforced slab and roof.

Each tank is insulated to maintain LNG at approximately -256°F (-160°C) and has sophisticated automatic protection systems to monitor the tank level, pressure, temperature and any potential leakage.

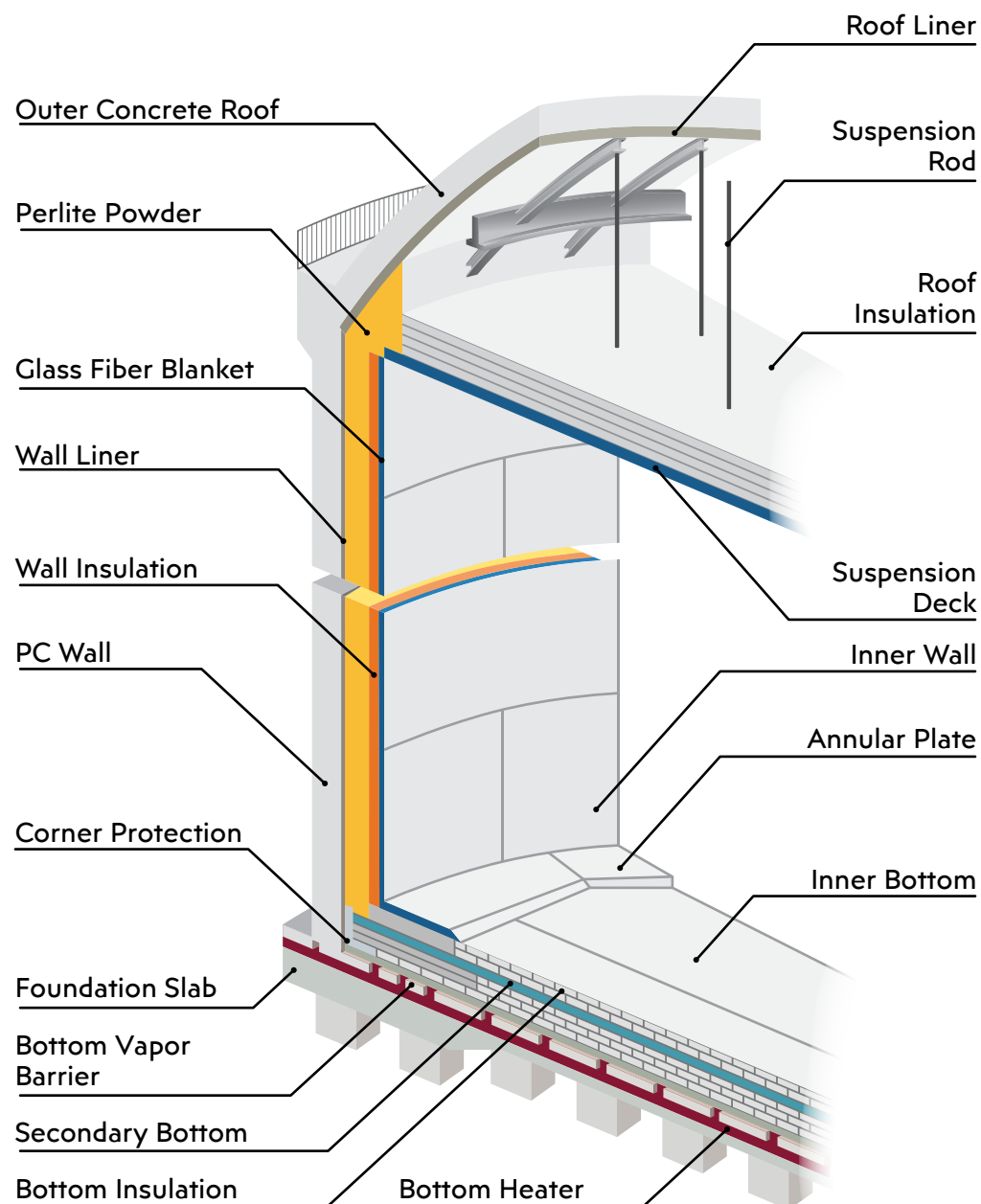

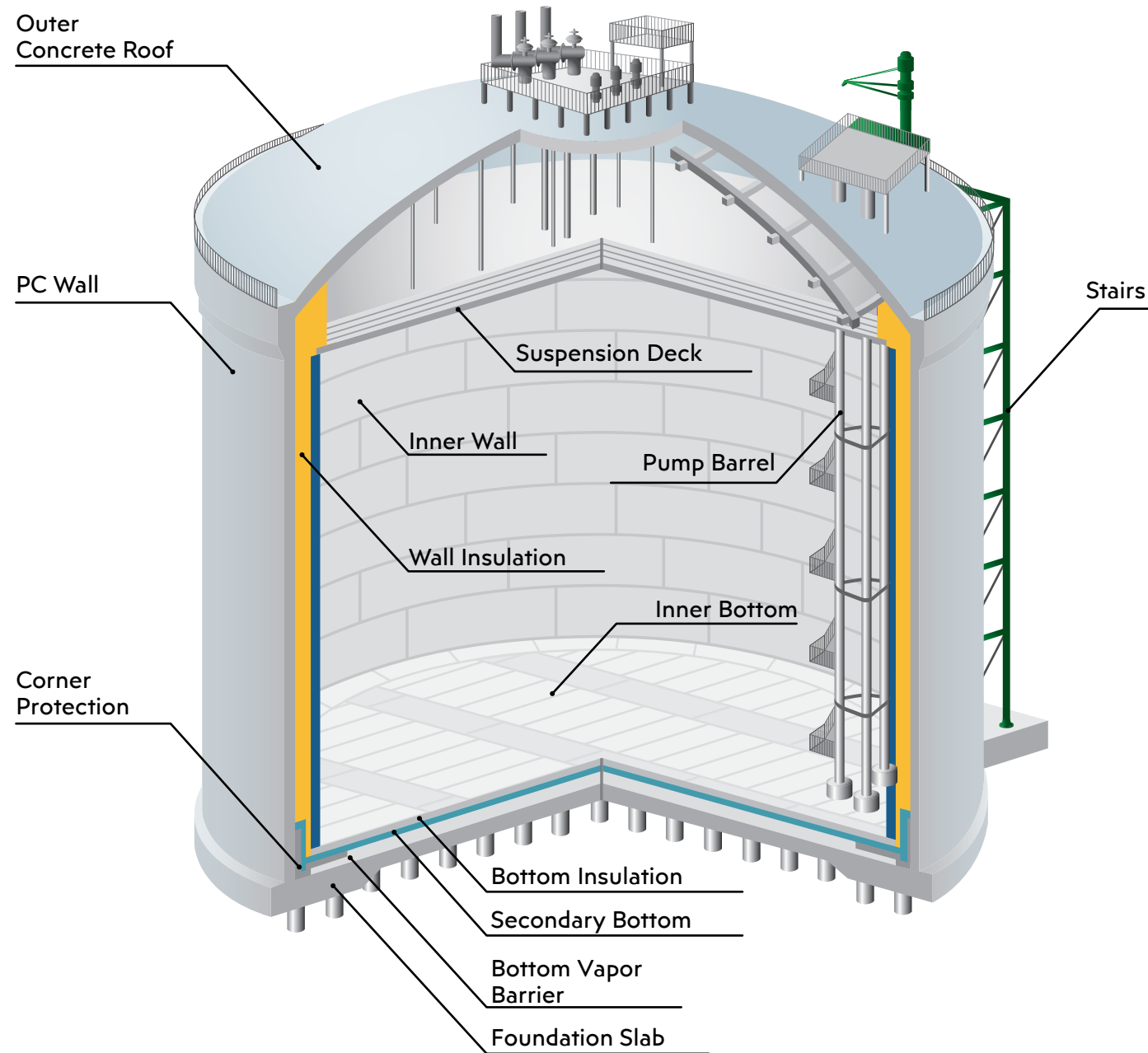



How is LNG transported?

LNG is transported in special double-hull ships. The most commonly used cargo-tank types are Membrane cargo tanks that are supported by the ship's hull and Type B Spherical (Moss) tanks that are self-supporting. Each type of cargo tank uses cryogenic materials for containment that are insulated to reduce the cargo boil-off to less than 0.15 percent per day. The LNG is off-loaded from the jetty to terminal storage tanks, which takes approximately 14-16 hours. The LNG remains at -160°C for the duration of the process. LNG has been transported commercially by ships since 1964 and as of the end of 2016 there have been 88,000 cargoes or 176,000 voyages without an LNG loss.

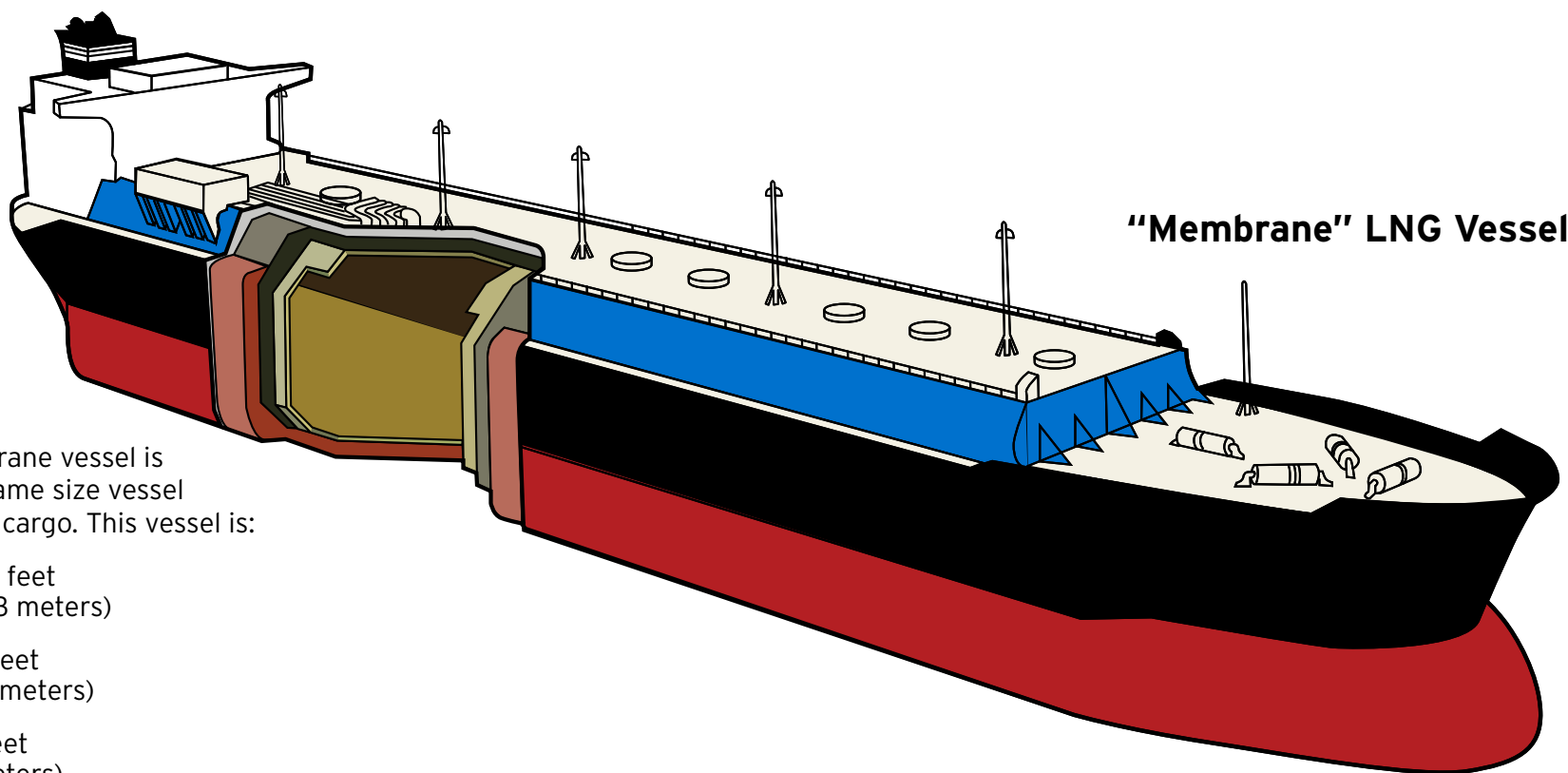

A 155,000 m³ membrane vessel is approximately the same size vessel as our average base cargo. This vessel is:

Length = 946.29 feet
= (288.43 meters)

Breadth = 145.14 feet
= (44.24 meters)

Draft = 37.73 feet
= (11.5 meters)



How is LNG turned into gas?

LNG is reheated with at least one heat exchanger and converted to gas using one of two common methods. In one technique, a small amount of the LNG is burned in a submerged combustion vaporizer, which produces the heat needed to gasify the remaining LNG.

The second method uses open rack vaporizers to gasify LNG with heat from ambient water, such as seawater or river water. LNG enters from the lower part of the vaporizer heat exchanger and exits as gas from the upper part.

The water is collected and eventually returned to its source.

“Moss” LNG Vessel

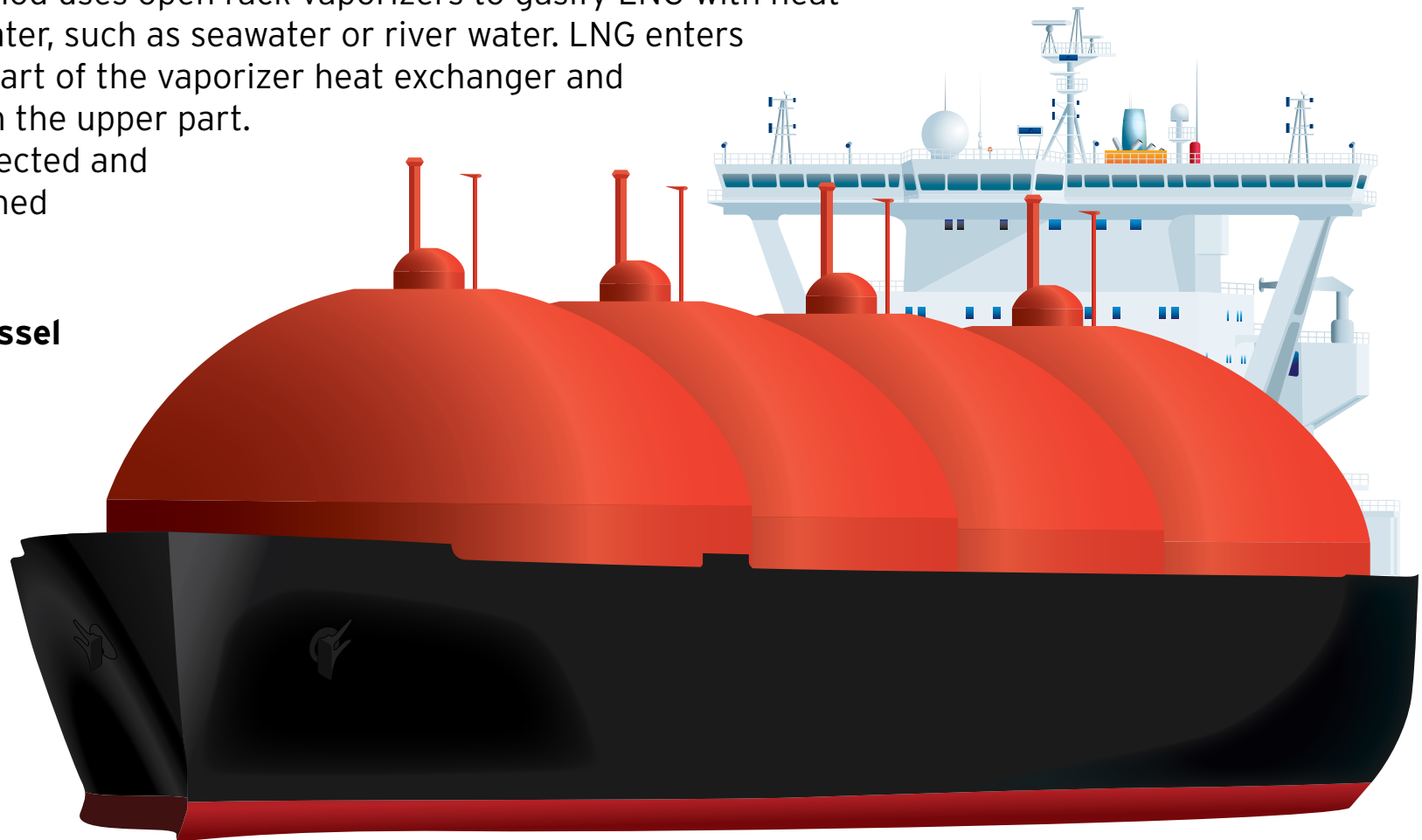



LNG GAS CHAIN

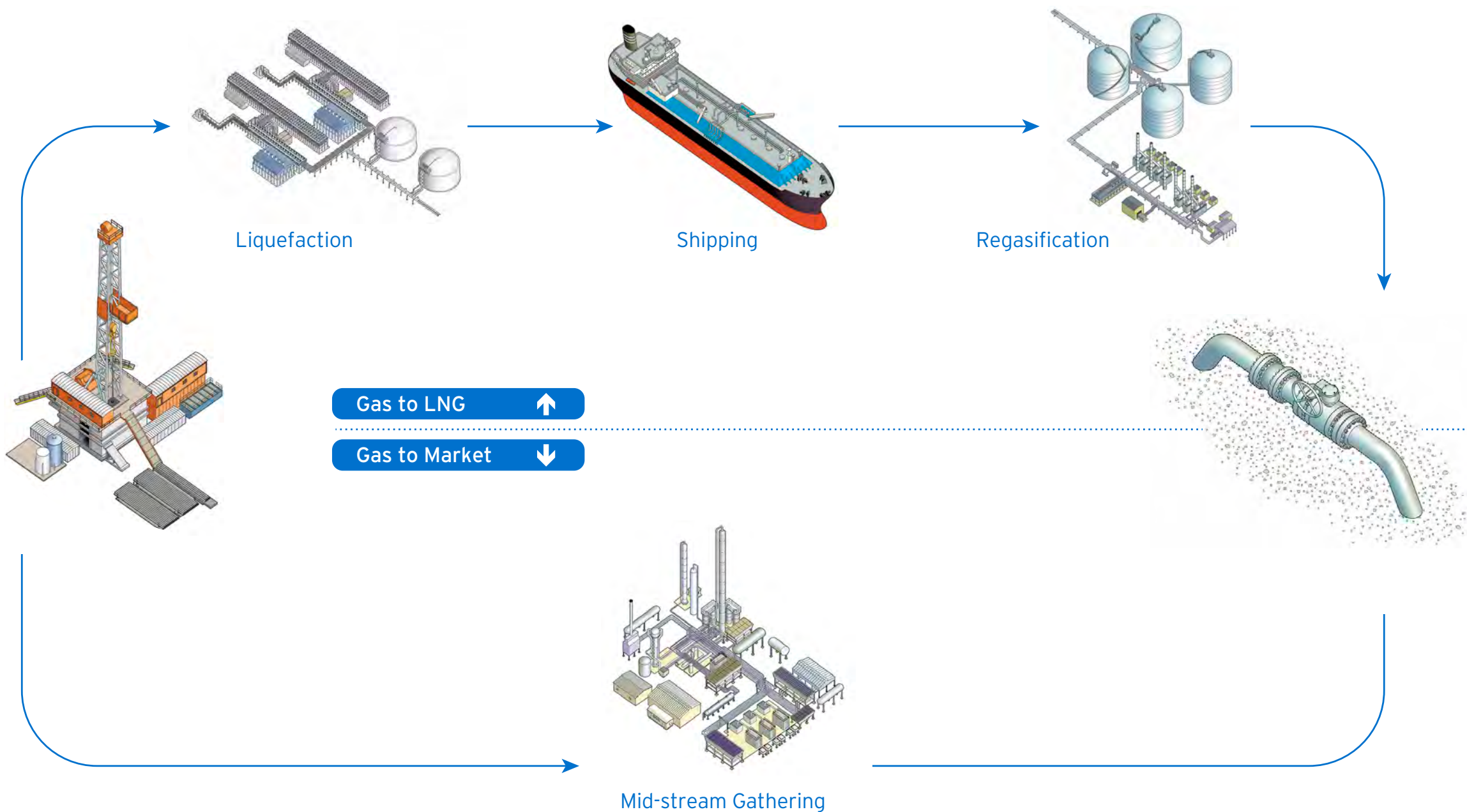

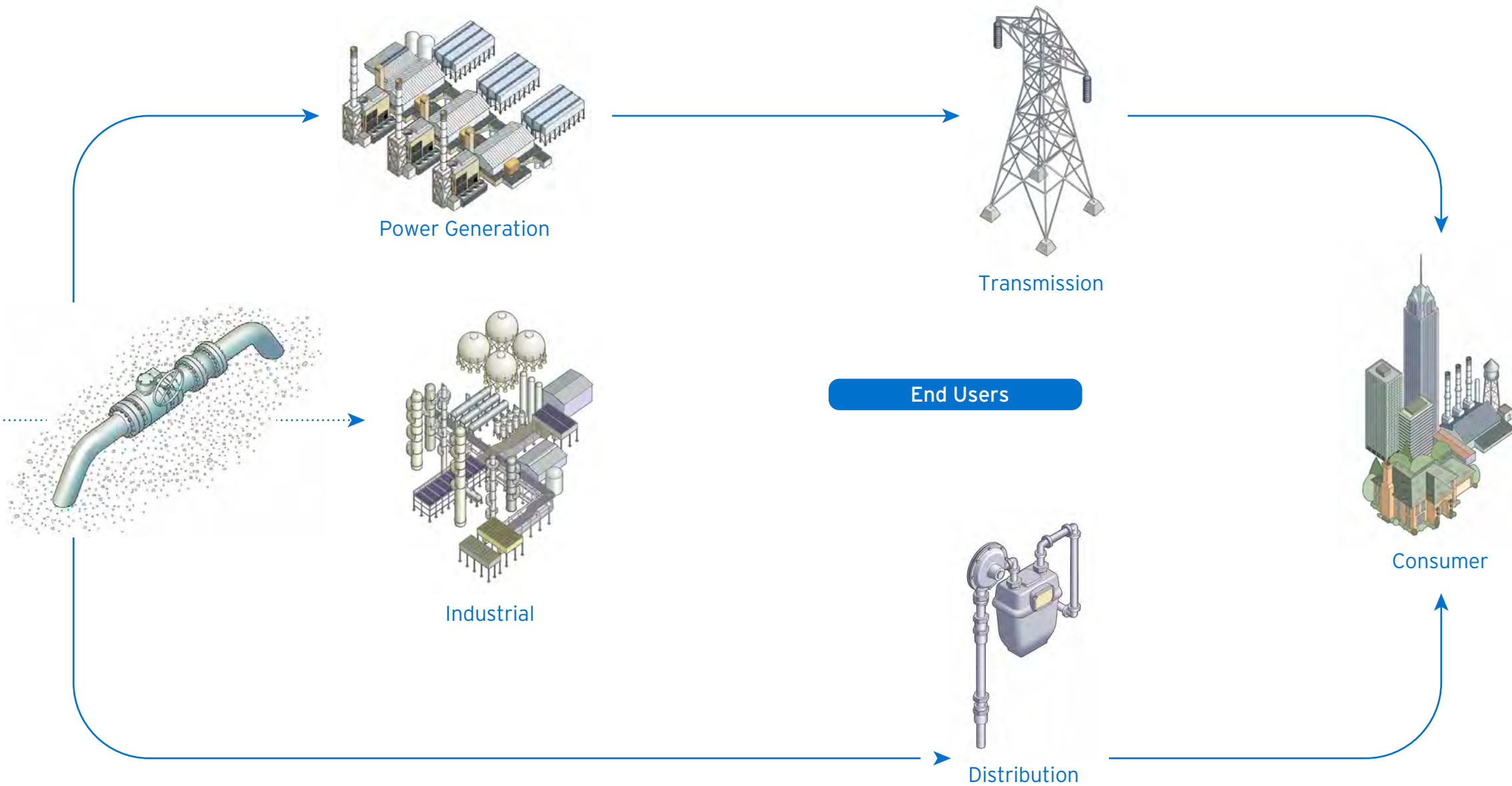



Hydration Station



Rendering, from north looking south



From south looking north 2017, 04-19



Rendering, from east looking west



From east looking west 2017, 04-19



Loading arms



Tanks at sunset



From east looking west 2017, 04-28



From south looking north 2017, 04-19



1st Cargo 2009, 06-26



From north looking south 2017, 04-19



2925 Briarpark Drive
Suite 1000
Houston, TX 77042
(832) 783-5500

301 Main Street
Gate "A"
Hackberry, Louisiana 70645
(337) 680-4677