



SNS COLLEGE OF TECHNOLOGY

An Autonomous Institution

Coimbatore-35



Accredited by NBA – AICTE and Accredited by NAAC – UGC with 'A+' Grade
Approved by AICTE, New Delhi & Affiliated to Anna University, Chennai

DEPARTMENT OF ELECTRONICS & COMMUNICATION ENGINEERING

19ECB301-ANALOG AND DIGITAL COMMUNICATION

III YEAR/ V SEMESTER

UNIT 4 – DIGITAL MODULATION TECHNIQUES

TOPIC – Phase Shift Keying (PSK)



PHASE SHIFT KEYING

In phase shift keying, the phase of the carrier is varied to represent two or more different signal elements (Both peak amplitude and frequency remain constant).

In binary PSK, we have only two signal elements: one with a phase of 0° , and the other with a phase of 180° .

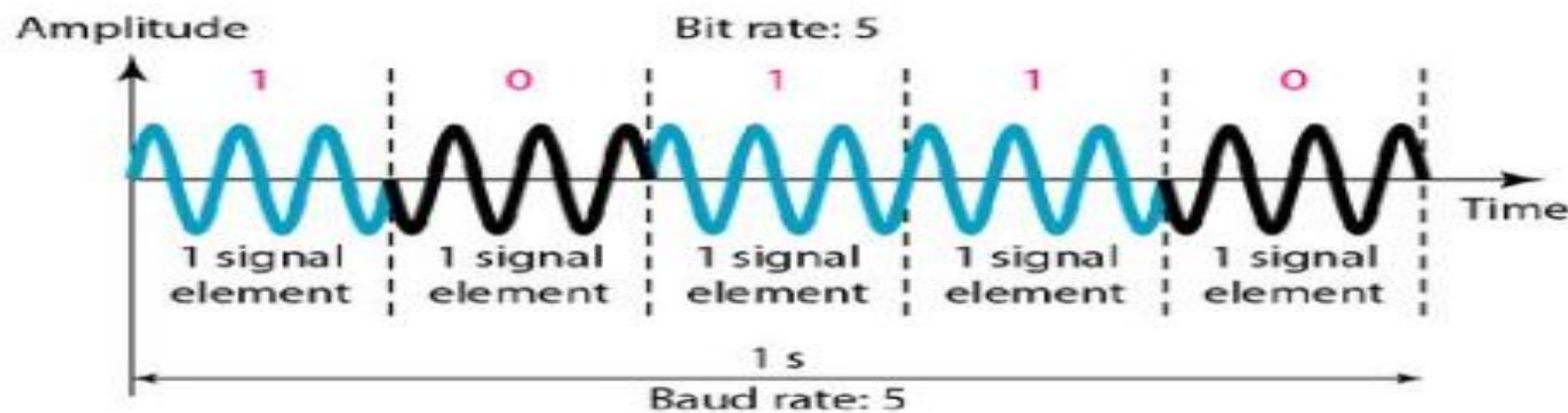

Bit	Phase
0	0
1	180

Bits

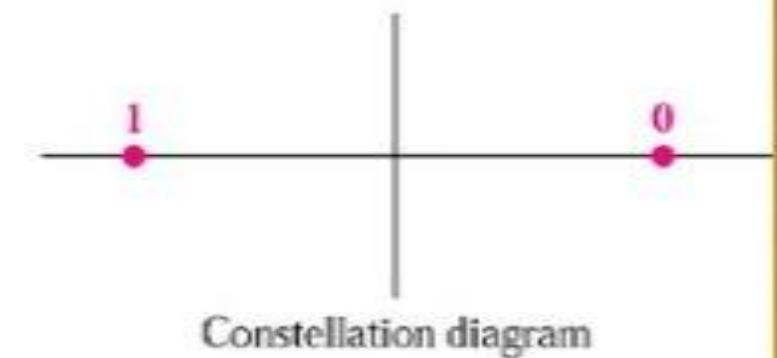



BANDWIDTH OF BINARY PSK

PSK is less susceptible to noise than ASK. ☉

PSK is superior to FSK because we do not need two carrier signals. ☉

The implementation of BPSK : ☉

the signal element with phase 180° can be seen as the complement of the signal element with phase 0° . ■

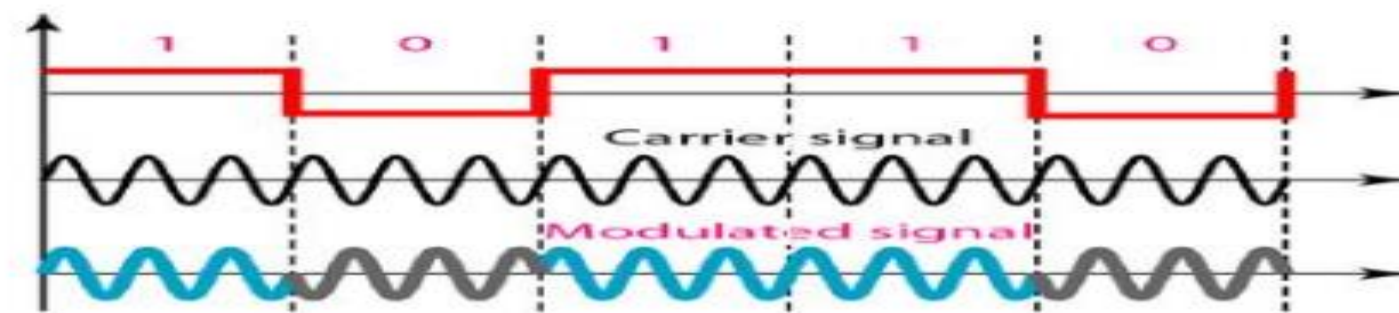



Introduction

- ❖ Phase-shift keying (PSK) is a method of digital communication in which the phase of a transmitted signal is varied to convey information.
- ❖ There are several methods that can be used to accomplish PSK.
- ❖ A digital modulation scheme that conveys data by changing the phase of a carrier wave.
- ❖ It can either determine the absolute phase relative to the unmodulated carrier or reference signal or the change in phase.
- ❖ The number of different phases used determines the amount of data that can be transmitted in each cycle.



Binary phase shift keying implementation

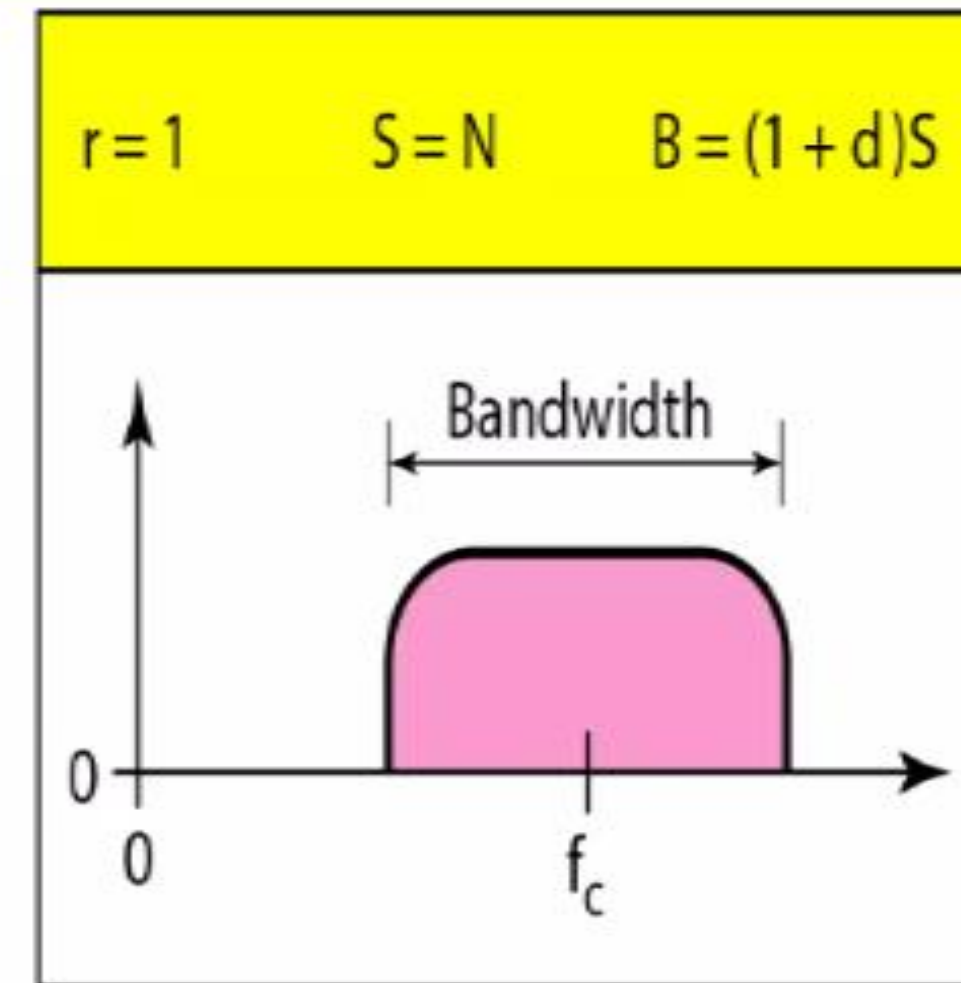
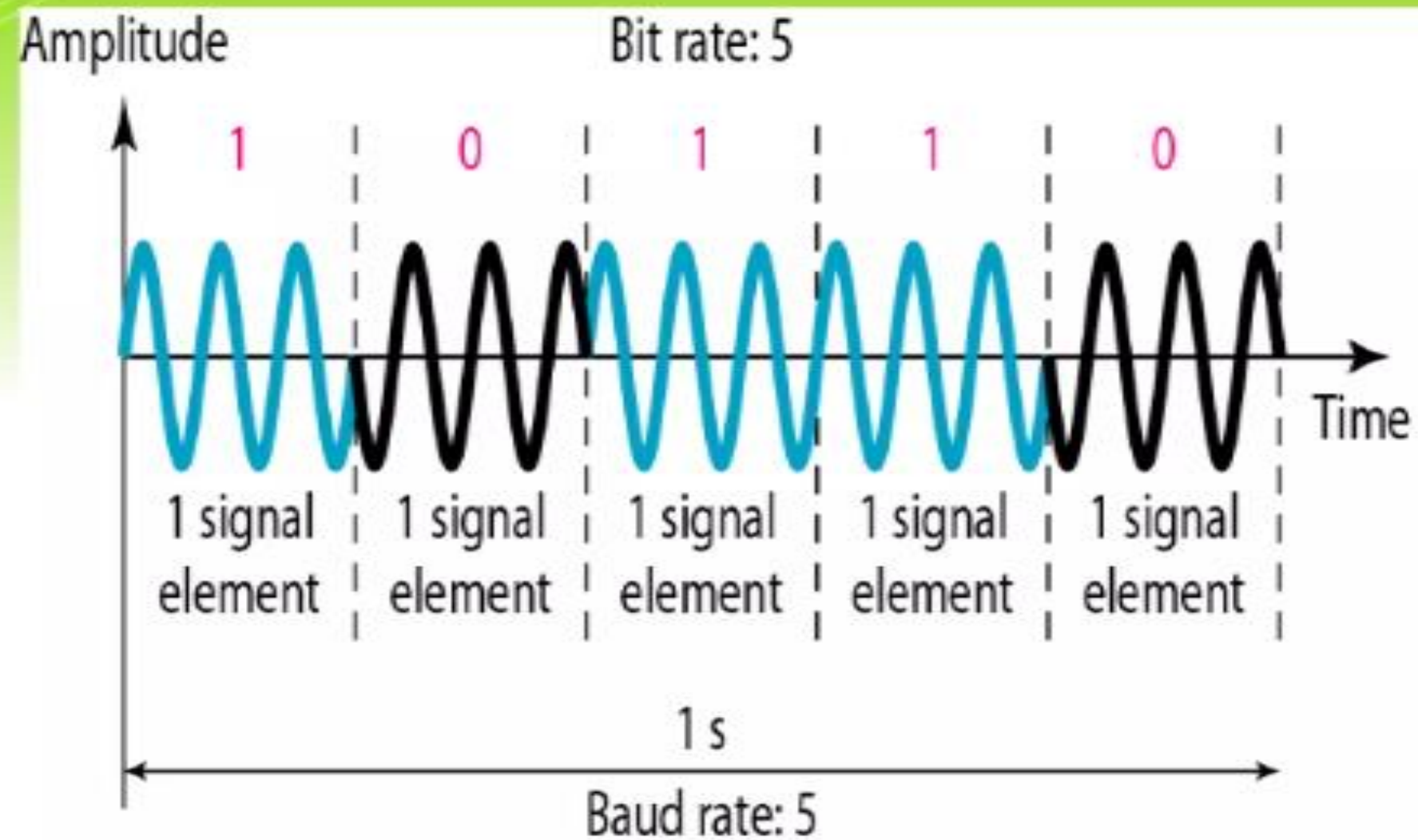



Quadrature Phase Shift Keying (QPSK)

- To increase the bit rate, we can code 2 or more bits onto one signal element.
- In QPSK, we parallelize the bit stream so that every two incoming bits are split up and PSK a carrier frequency. One carrier frequency is phase shifted 90° from the other in quadrature.
- The two PSK signals are then added to produce one of 4 signal elements.



QPSK and its implementation

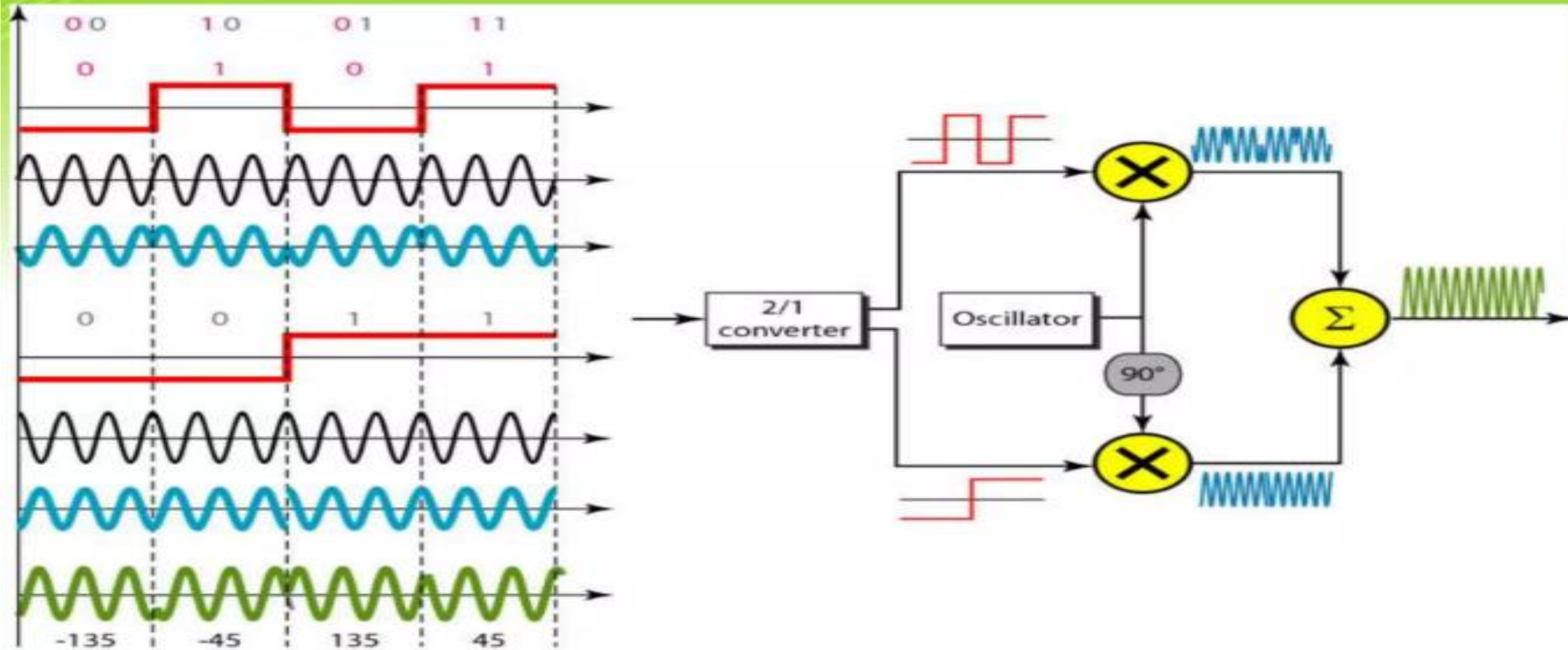



Three constellation diagrams

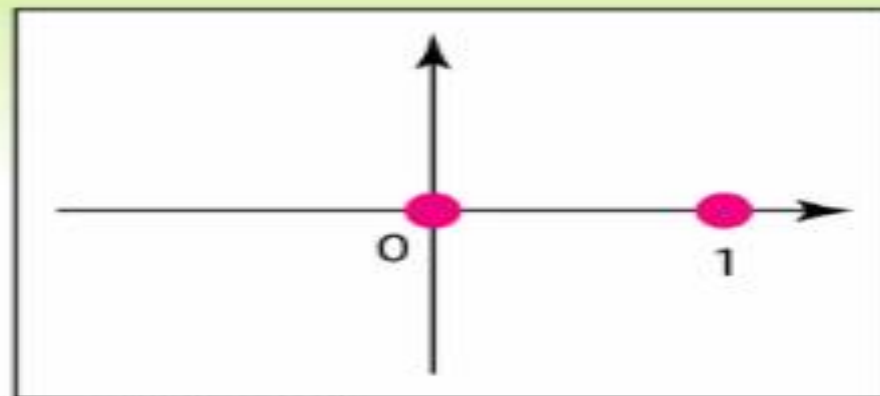

a. ASK (OOK)

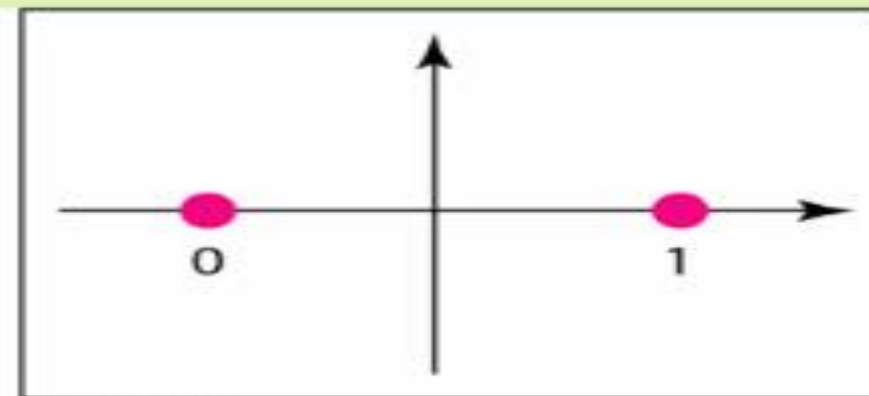

b. BPSK

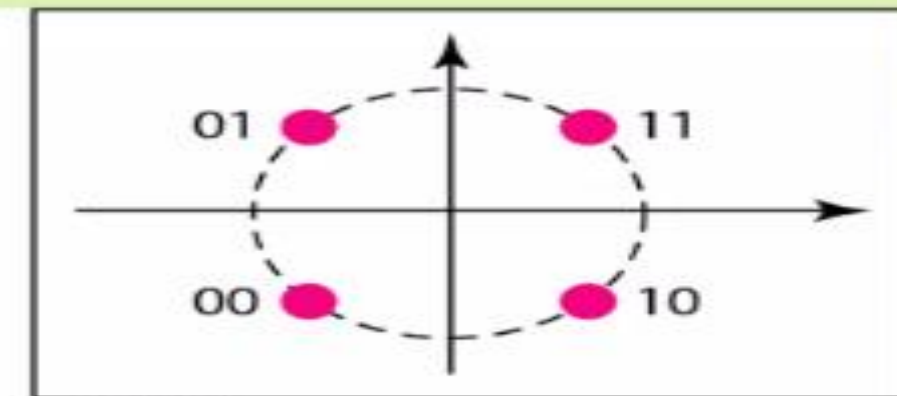

c. QPSK



Advantages

- It allows data to be carried along a radio communications signal much more efficiently than with frequent shift keying.
- Quadrature phase shift keying is another form of data transport where four phase states are used, all within 90 degrees of one another.



Disadvantages

- It is non-coherent reference signal.
- It produces more incorrect demodulations because the error can integrate with time since the reference signal for demodulation is not fixed.



Applications

- Optical communications
- Local oscillator
- Delay-and-add demodulator
- Nonlinear effects for WDM-transmission
- Multi-channel WDM



THANK YOU