

1.1: Introduction to Fusion 360

Fusion 360 is a cloud-based CAD/CAM tool for collaborative product development. The tools in Fusion enable exploration and iteration on product ideas and collaboration within a product development team.

Fusion 360 enables fast and easy exploration of design ideas with an integrated concept to production toolset. Fusion lets you focus on the form, function, and fabrication of your products. Use the sculpting tools to explore form and modeling tools to create finishing features. These tools let you quickly iterate on design ideas. Once you have settled on a design, you can create assemblies to validate fit and motion in your design or create photo-realistic renderings to verify the appearance. Finally, you need to fabricate your design. Use the 3D print workflows to create a rapid prototype or the CAM workspace to create tool-paths to machine your components.

Fusion 360 also helps bring design teams together for collaborative product development. All your designs are stored in the cloud, which means you and your team always access the latest data. Fusion also tracks versions of your design as you work. You can use Autodesk A360 to view each version in your web browser and promote an old version to the current version. Finally, use Fusion and A360 to share your designs and track design activity. You can even provide controlled access to your designs without requiring an Autodesk ID.

Fusion 360 uses a hybrid environment that harnesses the power of the cloud when necessary and uses local resources when it makes sense. For example, your design data is stored on the cloud and renders amazing images every time you save a new version of your design. This happens in parallel while you are creating and editing designs locally on your machine. This allows you to harness the power of your computer and the power of the cloud at the same time.

Throughout this course, you explore these areas of Fusion 360. This course gets you started designing with Fusion and helps you understand how it can improve your design processes.

1.2: Preferences

Preferences control default settings in Fusion. The Preferences dialog contains many pages of settings. Any changes you make to the preferences are saved with your Autodesk ID and are loaded when you log into another machine.

Some important preferences to review:

- General: general settings such as versioning (saving), pan, zoom, and orbit.
- General > Design: settings for the design workspaces: model, sculpt, patch.
- General > Drawing: settings for the creation of drawings.
- Material: controls the default physical material and appearance.
- Unit and Value Display: sets the precision and display of units.
- Default Units > Design and CAM: sets the default unit type.

Lesson 1: Setting Your Preferences

Learning Objectives

1. Access preferences
2. Modify preferences settings

Datasets Required

No dataset are required. You start with a new empty design.

Step-by-step Guides

Step 1: Access the preferences dialog box.

1. Click on your name in the upper right corner then select Preferences.

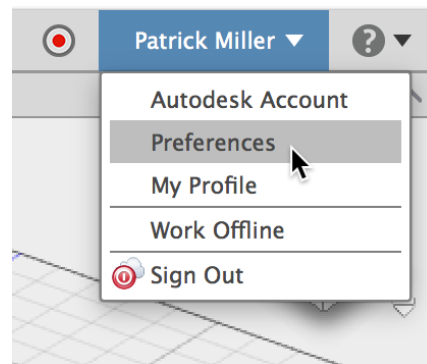

Step 2: Change the General settings.

1. Click General in the preferences list.
2. Scroll to Pan, Zoom, Orbit shortcuts.
3. Select the CAD application you are most comfortable with. This changes the mouse behavior for pan, zoom, and orbit.
4. Scroll through the other options in the General page.

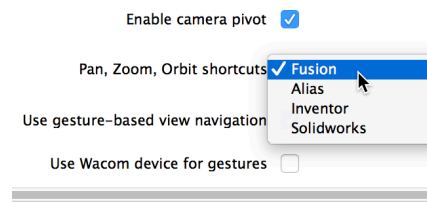

Step 3: – Review the other pages.

1. The Preferences dialog contains multiple pages. Click through the other pages to review the available settings.

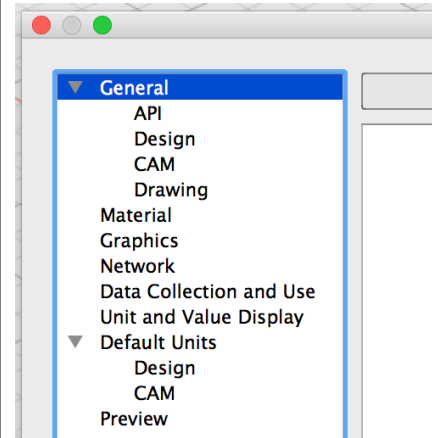

Step 4: – Reset the preferences.

1. If desired, click Restore Defaults in the lower left of the Preferences dialog. This resets all settings to the installed settings.

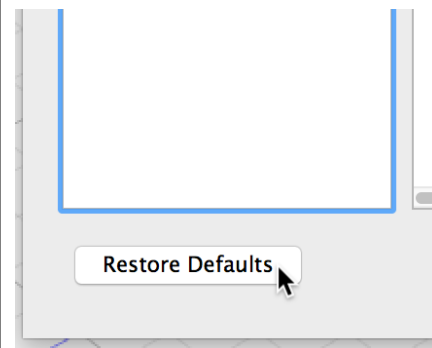

1.3: User Interface

The UI can be broken up into 8 areas. To help you become familiar with the product we will describe each of these areas and go into more details with how to use it in the following lessons.

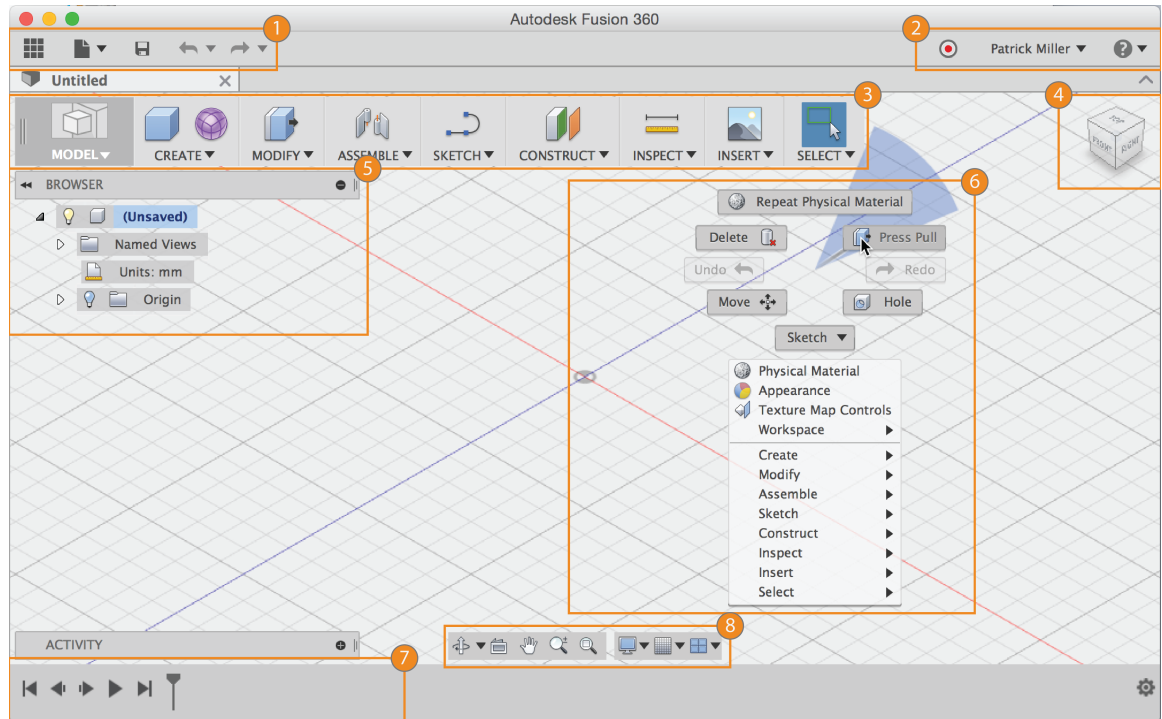

1

Application bar

The Application bar is where you'll find and use the following:



Data Panel – Used for data management and collaboration.



File – Create a New Design, Save, Export, and 3D Print.



Save – Save an untitled design or save the changes to a design as a new version.



Undo/redo – Undo/redo operations.

2

Profile and help

In profile you can control your profile and account settings, or use the help menu to continue your learning or get help in troubleshooting.

Profile – In your profile you can access your own personal settings.



Help – In the help menu you can access online learning content, help, forums, step-by-step tutorials, or link to community content.







3

Toolbar

Use the Tool bar to select the workspace you want to work in, and the tool you want to use in the workspace selected.

Your Workspaces

Fusion 360 uses these workspaces to control the commands that are available and the type of data that is created.

	The Sculpt workspace is used to create organic shapes by manipulating faces, edges, and vertices.
	The Model workspace is used to create solids with hard edges and flat faces.
	The Patch workspace is used to create open surfaces to stitch into solid bodies.
	The Render workspace is used to set up the environment and create photo-realistic renderings.
	The CAM workspace is used to create and simulate tool-paths then generate g code for subtractive manufacturing.
	The Animation workspace is used for to create exploded views of an assembly and control over unique animations of parts and assemblies.
	The Drawing workspace is used to generate 2D manufacturing drawings.

Note:

*Very frequently, your designs will require that you work in **both sculpt and model workspaces**, back and forth. You might even throw **patch in there to stitch surfaces** together into a solid. Create the organic shape in sculpt then use model for manufacturing features afterwards.*

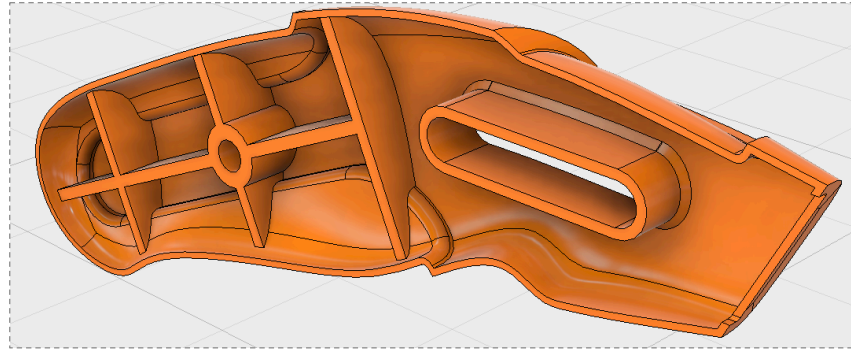

Note:

Use **model** to create designs with hard edges and flat faces. Model creates bodies requiring exact sizes and edges. Entering exact values is not required but is typical.

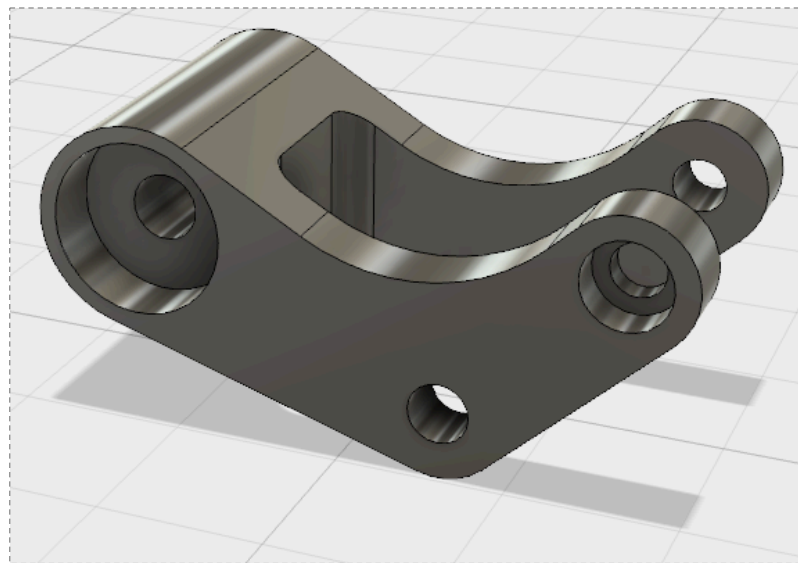

4

ViewCube

Use the ViewCube to orbit your design or view the design from standard view positions.

5

Browser

The browser lists objects in your design. Use the browser to make changes to objects

and control visibility of objects.

Canvas and marking menu

6

Left click to select objects in the canvas. Right-click to access the marking menu. The marking menu contains frequently used commands in the wheel and all commands in the overflow menu.

Timeline

7

The timeline lists operations performed on your design. Right-click operations in the timeline to make changes. Drag operations to change the order they are calculated.

Navigation bar and display settings

8

The navigation bar contains commands used to zoom, pan, and orbit your design. The display settings control the appearance of the interface and how designs are displayed in canvas.

Lesson 1: User Interface Overview

Learning Objectives

1. Familiarize yourself with the UI by creating a simple design
2. Use the toolbar
3. Use the marking menu
4. Control objects in the browser
5. Control operations in the timeline
6. Change workspaces

Datasets Required

No dataset required. You start with a new empty design.

Step-by-step Guides

Step 1: Create a new design

1. Click  then select **New Design**.

Step 2: Create a box

1. Click Model > Create > Box to start the box command.
2. Select the XZ Plane along the bottom of the canvas.
3. Pick two points to define the length and width of the box.
4. In the Box dialog, use these values:
Length: **100 mm**
Width: **100 mm**
Height: **50 mm**
5. Click **OK**.

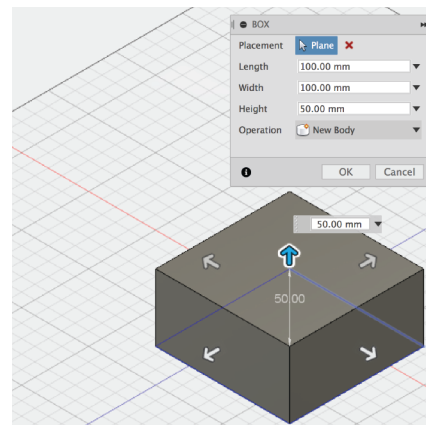

Step 3: Add a hole to the box

1. Click Model > Create > Hole.
2. Select the top face of the box.
3. Drag the center of the hole to the center of the box.
4. Set Diameter to a value of **50 mm**.
5. Change Extents to **All**.
6. Click **OK**.

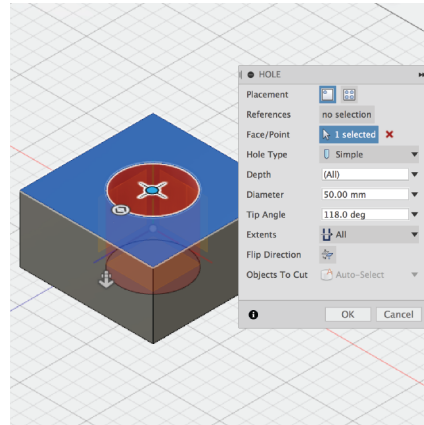

Step 4: Round the edges of the box

1. Right-click an empty area in the canvas then select **Press Pull**.
2. Hold the left mouse button then drag to window select the entire box.
3. Click the top and bottom edges of the hole to deselect the edges.
4. Enter **8 mm** for the Radius.
5. Right-click then select **OK**.

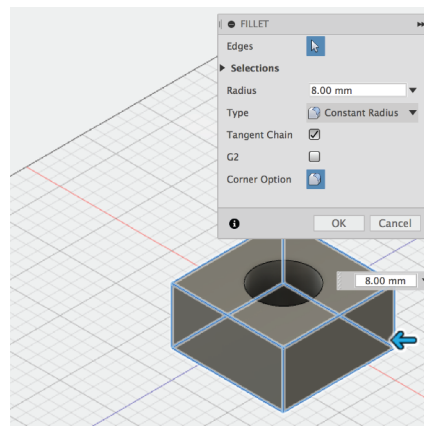

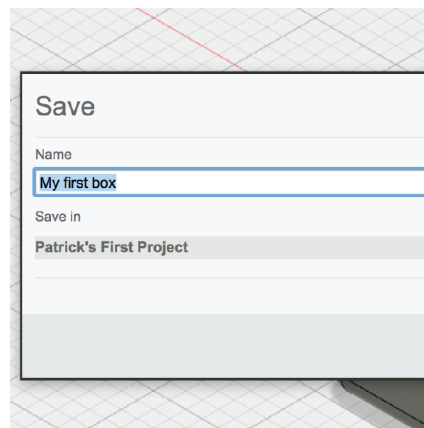

Step 5: Save your design

1. Click  to save the design.
2. Enter **My first box** in the Name field.
3. Set Save in to **<your name>'s First Project**.
4. Click **Save**.



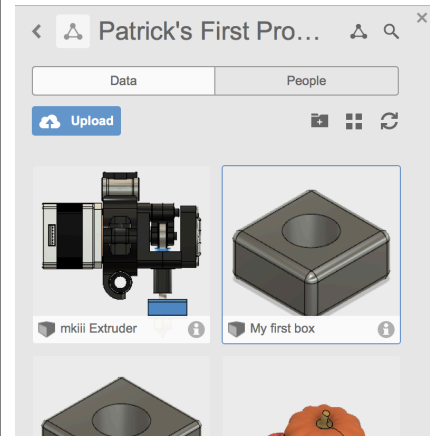

Step 6: Display the Data Panel

1. Click  in the upper left corner to display the Data Panel.
2. The active project name is displayed at the top. Thumbnails of all the designs in the project are listed. All data is stored in A360 in the cloud.
3. Click  again to hide the Data Panel.



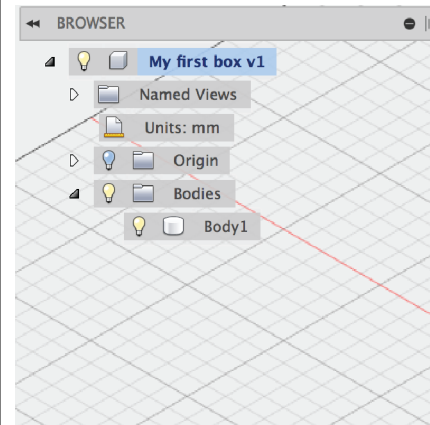

Step 7: Use the browser

4. Click  next to Origin to display the origin planes.
5. Click  the light bulb again to turn the origin planes off.
6. Click  next to Bodies in the browser to expand the folder. There is one body in this design.





Step 8: Use the timeline

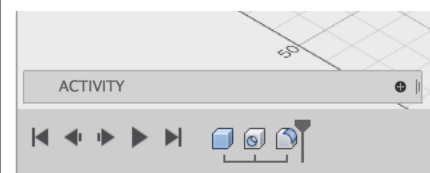

1. Click  to replay the operations in the design.
2. Right-click the  fillet operation in the timeline.
3. Change the Radius to **5 mm** and click **OK**.



Step 9: Change workspaces

1. Select  then select  to switch to the render workspace. Notice the canvas appearance

changes and the timeline is replaced with the Rendering Gallery. This workspace is used to render images of your design.

2. Notice the Rendering Gallery at the bottom of the interface. This gallery displays a thumbnail of your cloud renderings and shows the progress of renderings that are in process.
3. If the renderings have been processed, click on one of the thumbnails to display the image.
4. Close the Cloud Rendering dialog.
5. Select  then select  to return to the model workspace.
6. Keep the design open. You will use it in the next lesson.



1.4: Navigation

There are three ways to manipulate the view of your design:

- Navigation bar
- ViewCube
- Wheel button on a mouse

Navigation bar

Use the commands in the Navigation bar to pan, zoom, and orbit the canvas. The menus on the right end control Display Settings and Layout Grid options.



ViewCube

Use the ViewCube to orbit the design in the canvas. Drag the ViewCube to perform a free orbit. Click faces and corners of the cube to access standard orthographic and isometric views.

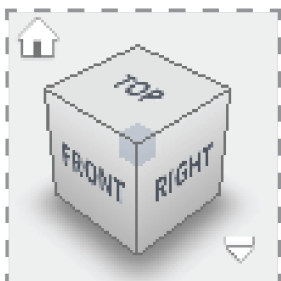

Mouse

Use mouse shortcuts to zoom in/out, pan the view, and orbit the view.



Scroll middle mouse button to zoom in or zoom out.



Click and hold middle mouse button to pan the view.

SHIFT +



Shift Key + middle mouse button to orbit the view.

Mac Trackpad



Use the **2 finger pinch** to zoom out.



Use the **2 finger spread** to zoom in.



Use the **2 finger swipe** to pan the view



Hold Shift + the 2 finger swipe to orbit the view

Lesson 1: Navigate the canvas

Learning Objectives

1. Use the commands in the Navigation Bar
2. Use the mouse to zoom and orbit the design



3. Use the ViewCube to navigate the design

Datasets Required

Use the design from the previous lesson.

Step-by-step Guides

Step 1: Use the Navigation Bar

1. Click  Orbit then drag within the circle.
2. Click  Pan then drag in the canvas to pan.
3. Click  Zoom then drag up and down in the canvas to zoom in and zoom out.

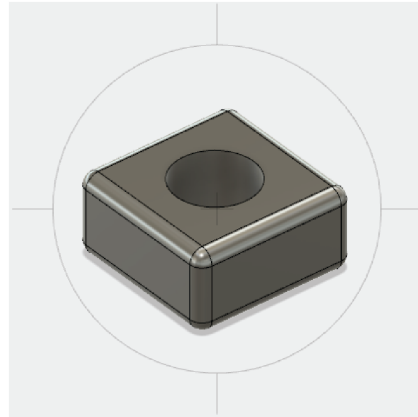

Step 2: Use the mouse

1. Roll the wheel forward and backward to zoom in and zoom out.
2. Click and hold then drag to pan.
3. Hold the Shift key then drag with the middle mouse button to orbit the design.
4. Double-click the middle mouse button to zoom extents.



Note: if you changed the Pan, Zoom, Orbit shortcuts preference then your mouse wheel will behave differently.

Step 3: Use the ViewCube

1. Left click and drag the ViewCube to orbit the design.
2. Click one of the corners of the cube to go to an isometric view.
3. Click on the FRONT face to go to the front orthographic view.



4. Click Home to return to the home view.

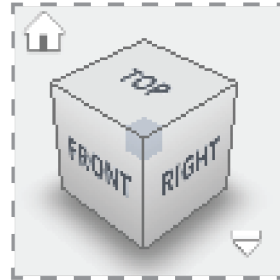





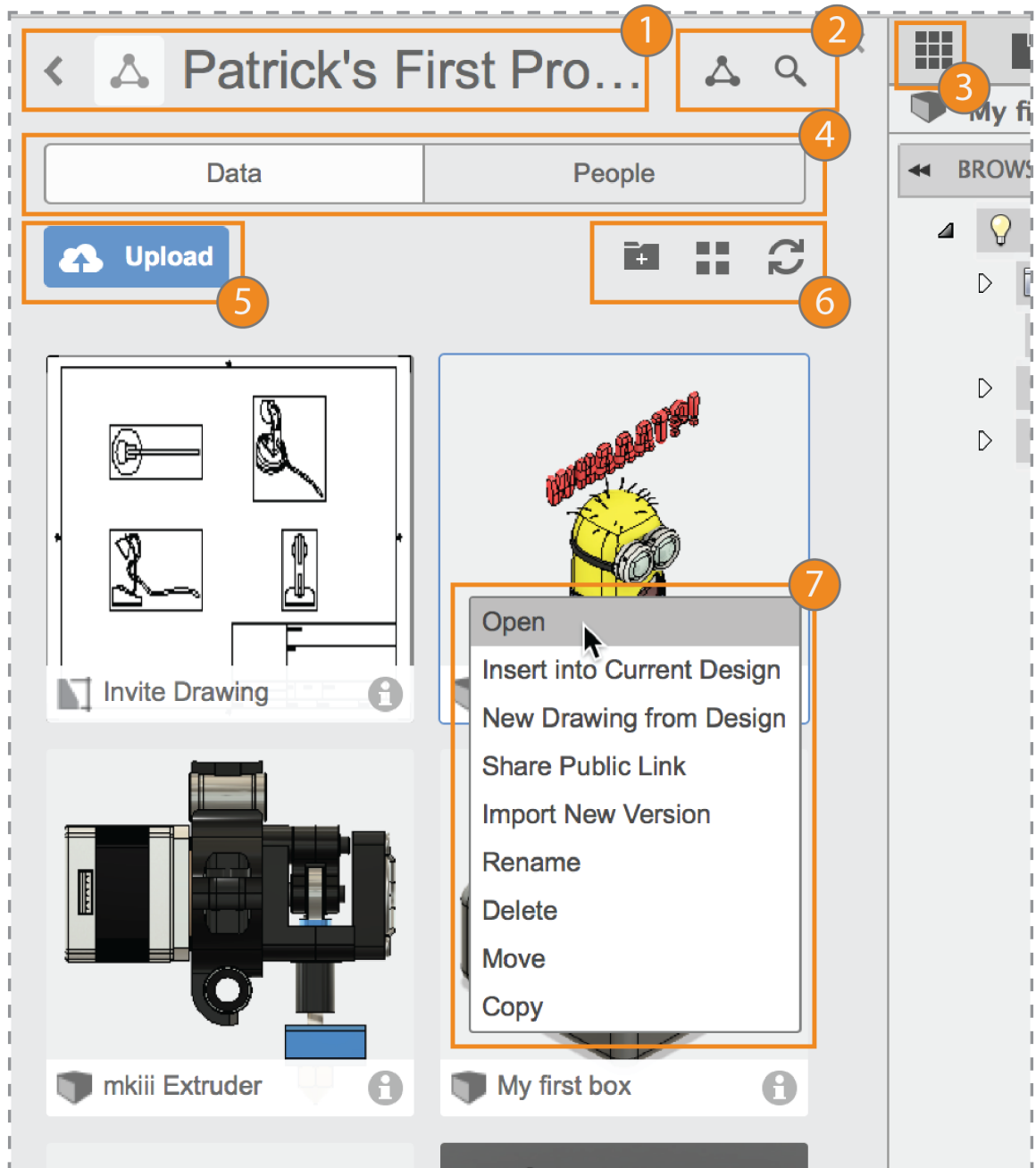





1.5: Data Panel Interface

Use the Data Panel on the left of the application to access your designs and manage projects.



- 1** Project selector
 Displays the name of the active project. Click the back arrow to display a project list.

- 2** Project tools
 Displays project data in Autodesk A360 or searches the active project.

	<p>Project Details – Opens the active project in Autodesk A360 in your default internet browser.</p>						
	<p>Search – Search the active project or all projects you have access to.</p>						
<p>3</p>	<p>Data Panel show/hide Click to show or hide the Data Panel.</p>						
<p>4</p>	<p>Data or People Controls the display of data or users in the Data Panel.</p>						
<p>5</p>	<p>Upload Click to upload data.</p>						
<p>6</p>	<p>View tools Create a new folder or change the display of items in the Data Panel.</p> <table border="1" data-bbox="391 1094 1372 1549"> <tr> <td data-bbox="391 1094 516 1247">  </td> <td data-bbox="516 1094 1372 1247"> <p>New Folder – Create a new folder in the active project.</p> </td> </tr> <tr> <td data-bbox="391 1247 516 1400">  </td> <td data-bbox="516 1247 1372 1400"> <p>View Options – Choose how to sort and list data.</p> </td> </tr> <tr> <td data-bbox="391 1400 516 1549">  </td> <td data-bbox="516 1400 1372 1549"> <p>Refresh – Refresh the data in the Data Panel.</p> </td> </tr> </table>		<p>New Folder – Create a new folder in the active project.</p>		<p>View Options – Choose how to sort and list data.</p>		<p>Refresh – Refresh the data in the Data Panel.</p>
	<p>New Folder – Create a new folder in the active project.</p>						
	<p>View Options – Choose how to sort and list data.</p>						
	<p>Refresh – Refresh the data in the Data Panel.</p>						
<p>7</p>	<p>Thumbnails Right-click a thumbnail to access commands for that specific design.</p>						

Lesson 1: Manage your design

Learning Objectives

1. Open a design
2. Change the active project

Datasets Required

Use the design from the previous lesson.

Step-by-step Guides

Step 1: Set the active project

1. Click the back button next to the active project in the Data Panel.
2. Double-click **<your name>'s First Project** to make that the active project.

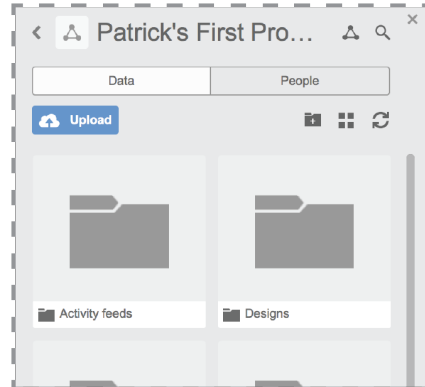

Step 2: Open a design

1. Click the **X** on the tab for My first box. The design is closed and you are presented with an empty design.
2. In the Data Panel, right-click on My first box then select **Open**.

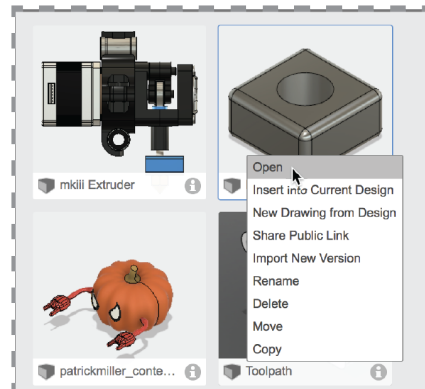

Step 3: Access the Fusion 101 Training project

1. Click the back button next to the active project in the Data Panel.
2. Scroll to the **SAMPLES** category.
3. Double-click Fusion 101 Training to set it as the active project. This project contains the data you will use for the other lessons in this course.

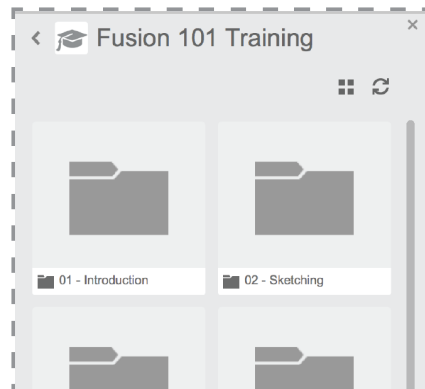

Keyboard Shortcuts

Command	Windows	Mac
Undo	Ctrl + Z	Command + Z
Redo	Ctrl + Y	Command + Y
Copy	Ctrl + C	Command + C
Paste	Ctrl + V	Command + V
Cut	Ctrl + X	Command + X

Sculpt Workspace Selection	Windows	Mac
Grow selection	Shift + Up arrow	Shift + Up arrow
Shrink selection	Shift + Down arrow	Shift + Down arrow
Loop selection	Alt + P	Control + P
Loop grow selection	Alt + O	Control + O
Ring selection	Alt + L	Control + L
Ring grow selection	Alt + K	Control + K
Ring shrink selection	Alt + J	Control + J
Previous U	Alt + Left arrow	Control + Command + Left arrow
Next U	Alt + Right arrow	Control + Command + Right arrow
Previous V	Alt + Down arrow	Control + Command + Down arrow
Next V	Alt + Up arrow	Control + Command + Up arrow
Range selection	Alt + M	Command + M
Invert selection	Alt + N	Command + N
Toggle box mode	Ctrl + 1	Ctrl + 1
Toggle control frame mode	Ctrl + 2	Ctrl + 2
Toggle smooth mode	Ctrl + 3	Ctrl + 3
Select edge ring	Double-click an edge	Double-click an edge
Select face ring	Select two faces then double-click a third face	Select two faces then double-click a third face

Edit Form Command	Windows	Mac
Add geometry	Alt + Drag	Option + Drag
Add geometry and keep creases	Alt + Ctrl + Drag	Option + Command + Drag