



SNS COLLEGE OF TECHNOLOGY

Coimbatore-35
An Autonomous Institution



Accredited by NBA – AICTE and Accredited by NAAC – UGC with 'A+' Grade
Approved by AICTE, New Delhi & Affiliated to Anna University, Chennai

DEPARTMENT OF ELECTRONICS & COMMUNICATION ENGINEERING

19ECT311 / Wireless Communication

III ECE/ VI SEMESTER

Unit II - ¹MOBILE RADIO PROPAGATION

TOPIC 8 – Small scale fading parameters



Small Scale fading

Fading is a phenomenon that occurs due to varying parameters and conditions of the channel during wireless propagation.

- Small-scale fading refers to the rapid changes of the amplitude and phase over
 - Short period of time
 - Short distance
- Small-scale fading depends on
 - The nature of the transmitted signal with respect to the characteristics of the channel.

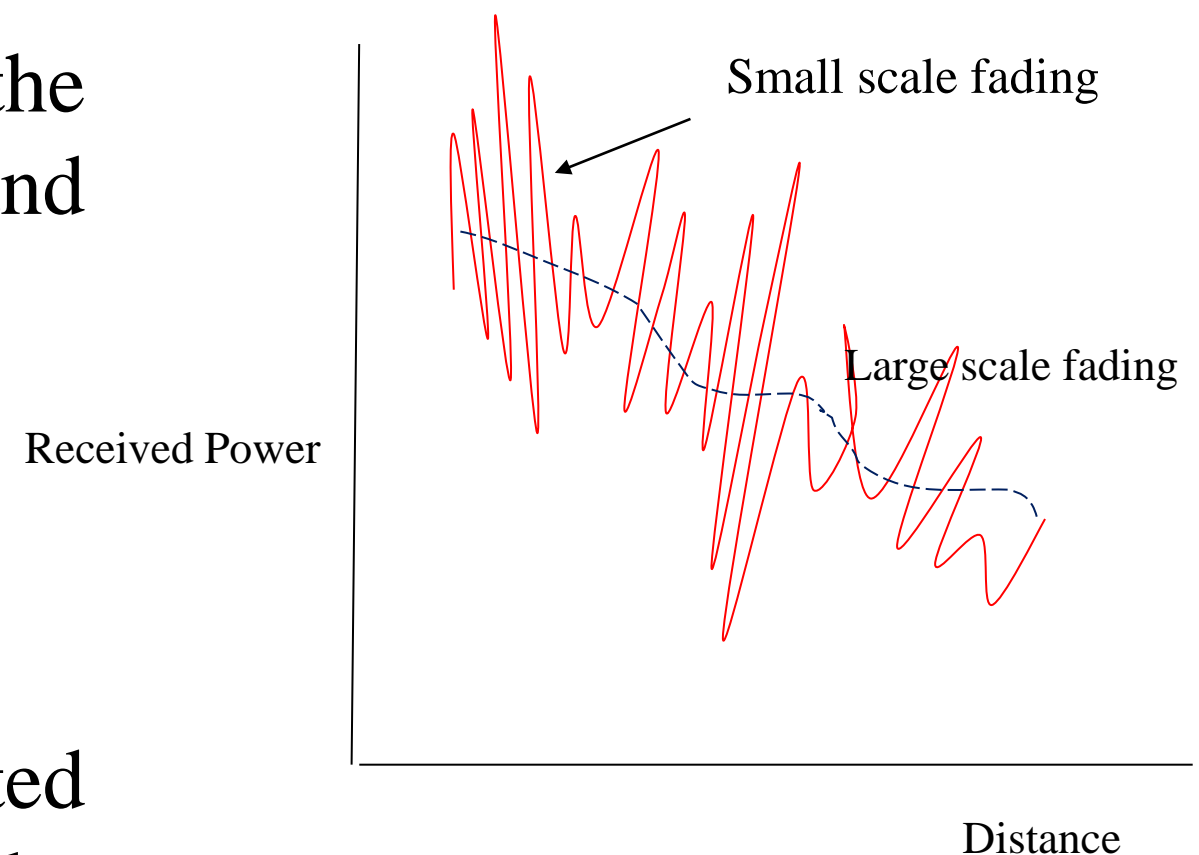



Factors influencing small-scale fading



■ Multipath propagation

- ❑ The presence of reflecting objects and scatterers in the space between transmitter and receiver creates a constantly changing channel environment
- ❑ Causes the signal at receiver to fade or distort

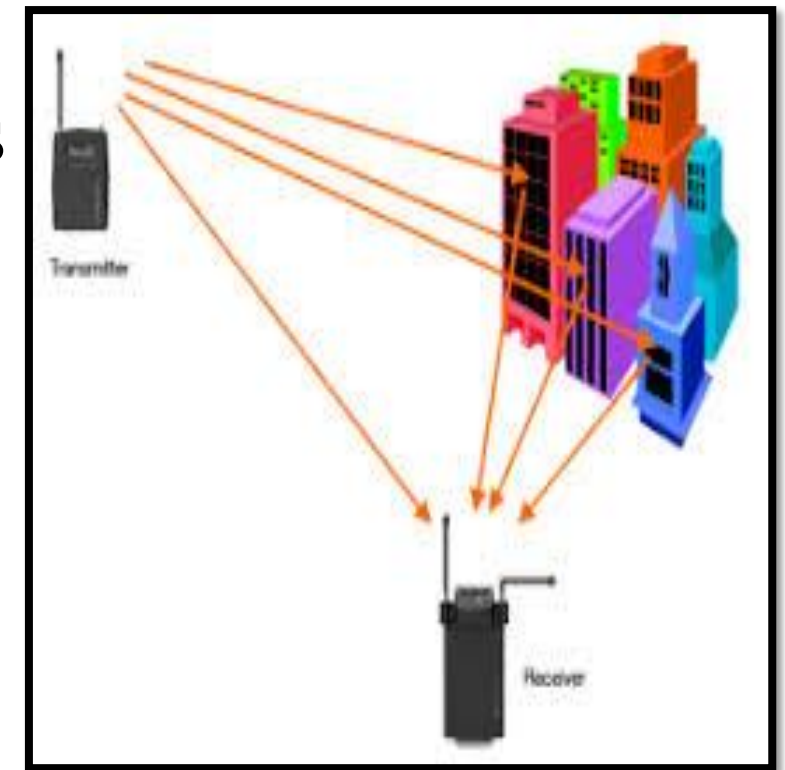

■ Speed of mobile receiver

- ❑ The relative motion between the transmitter and receiver results in a **random frequency modulation due to different Doppler shifts** on each of the multipath signals
- ❑ Doppler shift may be positive or negative depending on direction of movement of mobile



Factors influencing small-scale fading



- **Speed of surrounding objects:**
 - If the speed of surrounding objects is greater than mobile, the fading is dominated by those objects
 - If the surrounding objects are slower than the mobile, then their effect can be ignored



Factors influencing small-scale fading

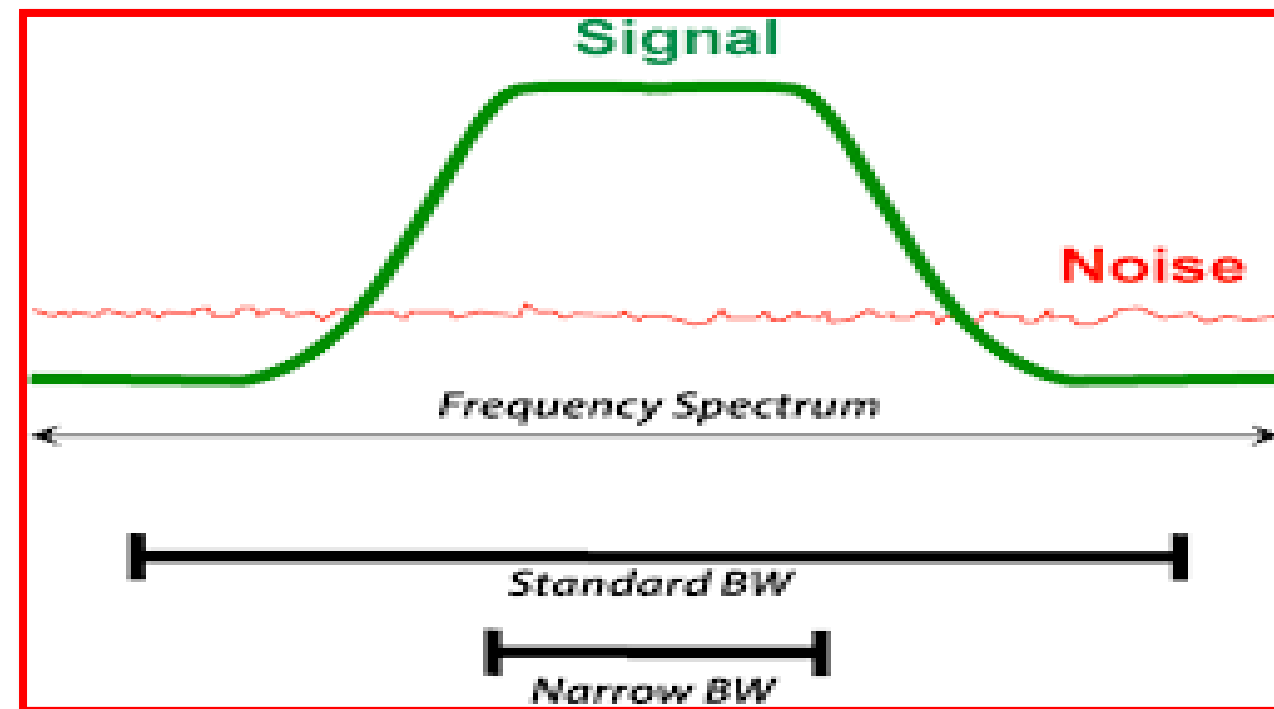

■ The transmission bandwidth:

- Depending on the relation between the signal bandwidth and the coherence bandwidth of the channel, the signal is either distorted or faded
- If the signal bandwidth is greater than coherence bandwidth it creates distortion
- If the signal bandwidth is smaller than coherence bandwidth it create small scale fading



Small-Scale Multipath Measurements



- Multipath structure is very important for small scale fading.
- Several Methods
 - Direct RF Pulse System
 - Spread Spectrum Sliding Correlator Channel Sounding
 - Frequency Domain Channel Sounding
- These techniques are also called channel sounding techniques



Direct RF Pulse System



- This method help us to determine the power delay profile directly
- Objective is to find impulse response
- A narrow pulse is used for channel sounding
- At the receiver the signal is amplified and detected using an envelop detector
- It is then stored on a high speed digital oscilloscope
- If the receiver is set on averaging mode, the local average power delay profile is obtained



Direct RF Pulse System

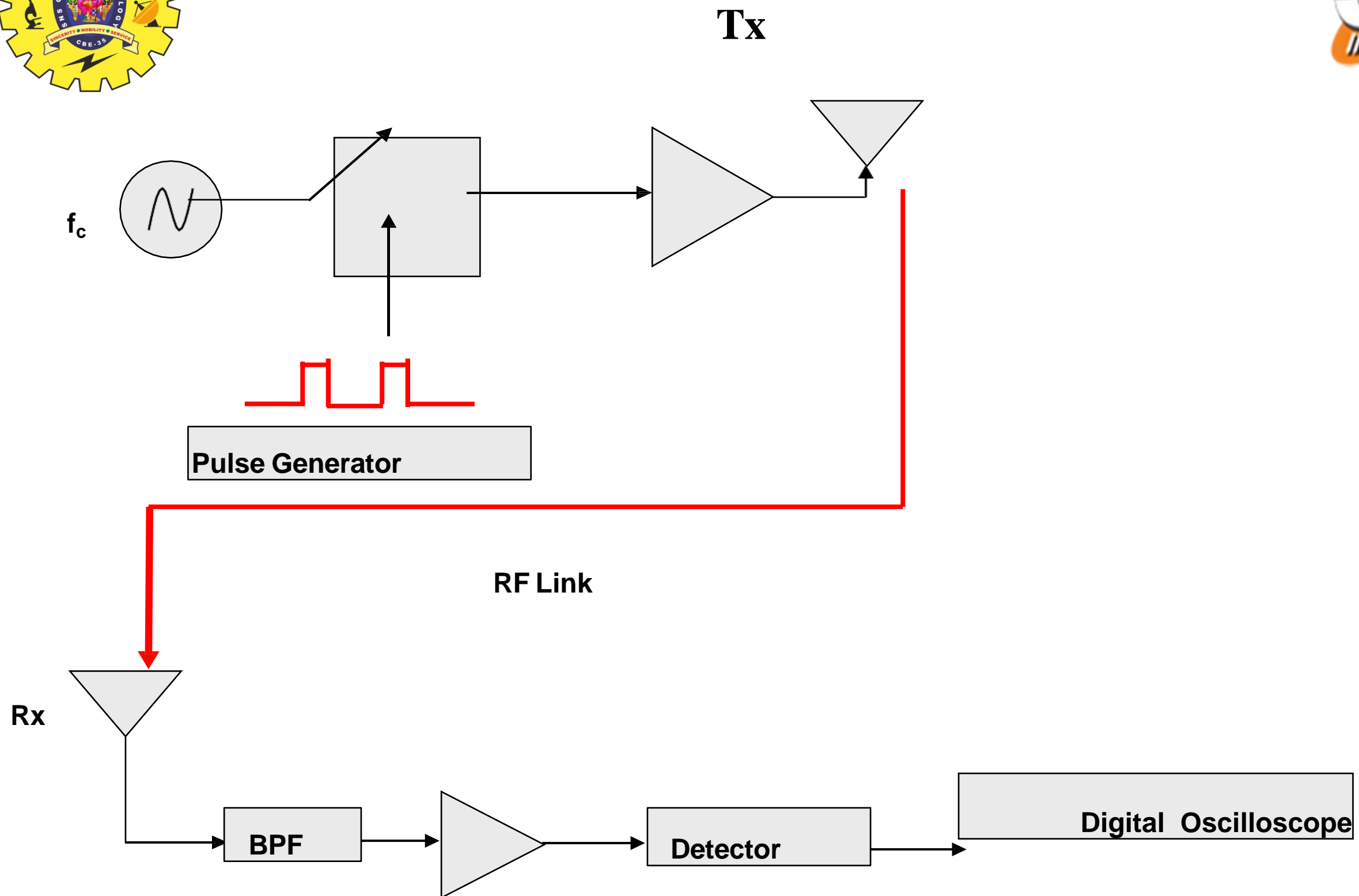



Delay Spread and Coherence Bandwidth



RMS Delay Spread

- Describes the time dispersive nature of a channel in a local area
- A received signal suffers spreading in time compared to the transmitted signal
- Delay spread can range from a few hundred nanoseconds for indoor scenario up to some microseconds in urban areas

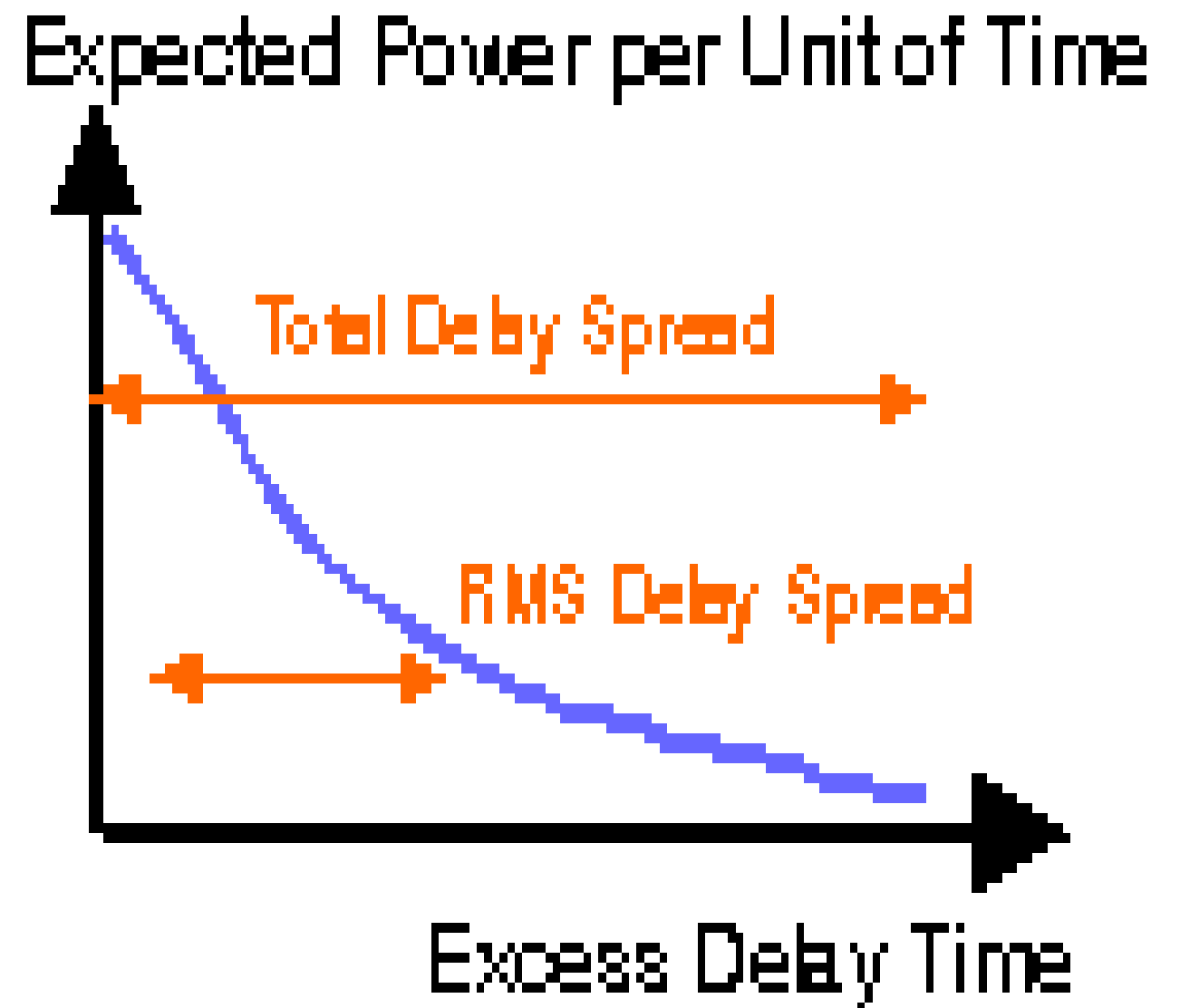



Maximum Excess Delay



Maximum Excess Delay (X dB):

- Defined as the time delay value after which the multipath energy falls to X dB below the maximum multipath energy

It is also called *excess delay spread*.

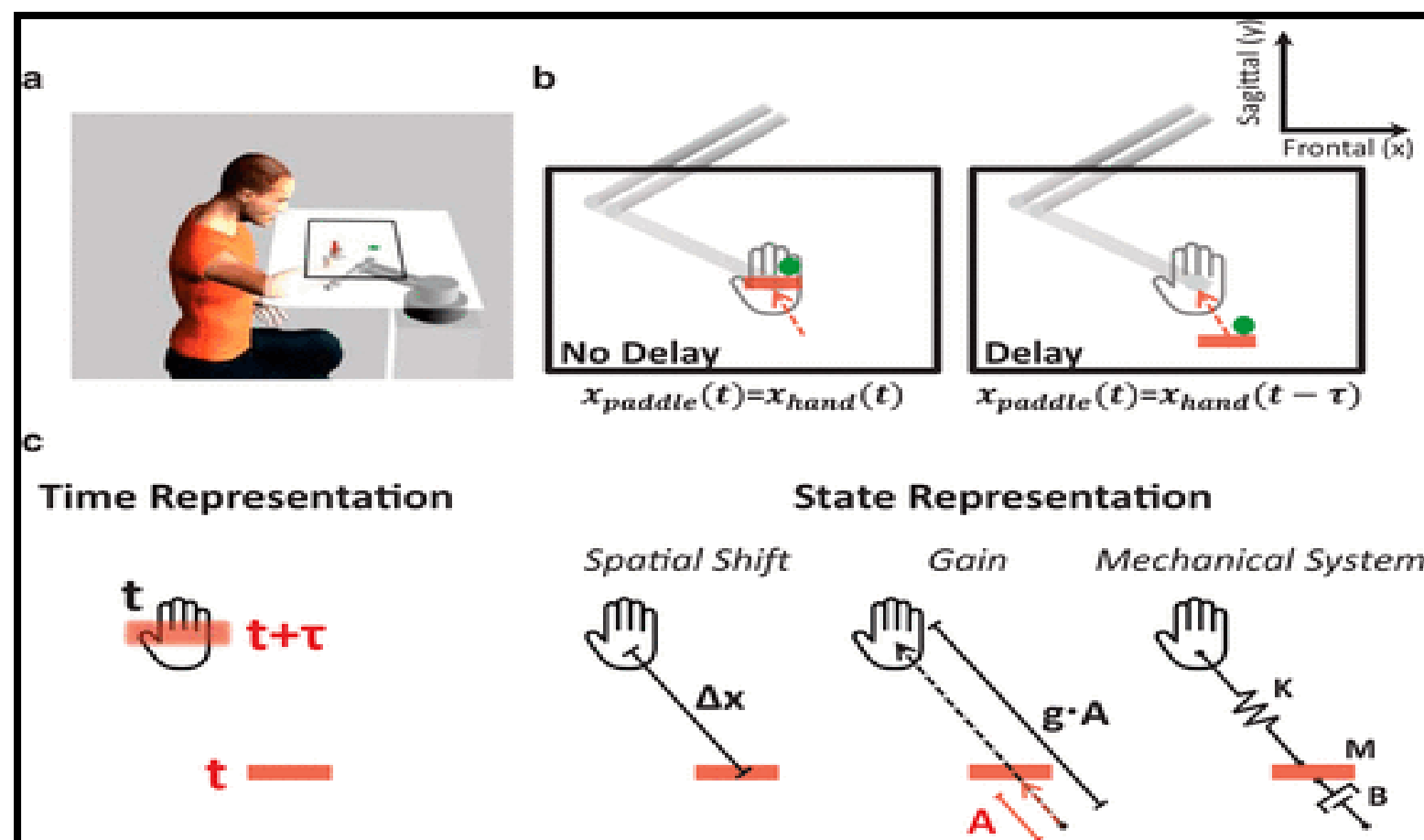



Coherence BW



- The coherence bandwidth B_c translates time dispersion into the language of the frequency domain
- It specifies the frequency range over which a channel affects the signal spectrum nearly in the same way, causing an approximately constant attenuation and linear change in phase
- The RMS delay spread and coherence bandwidth are inversely proportional to each other



Coherence Bandwidth (B_C)

- Range of frequencies over which the channel can be considered flat (i.e. channel passes all spectral components with equal gain and linear phase).
 - It is a definition that depends on RMS Delay Spread.
- Two sinusoids with frequency separation greater than B_C are affected quite differently by the channel.

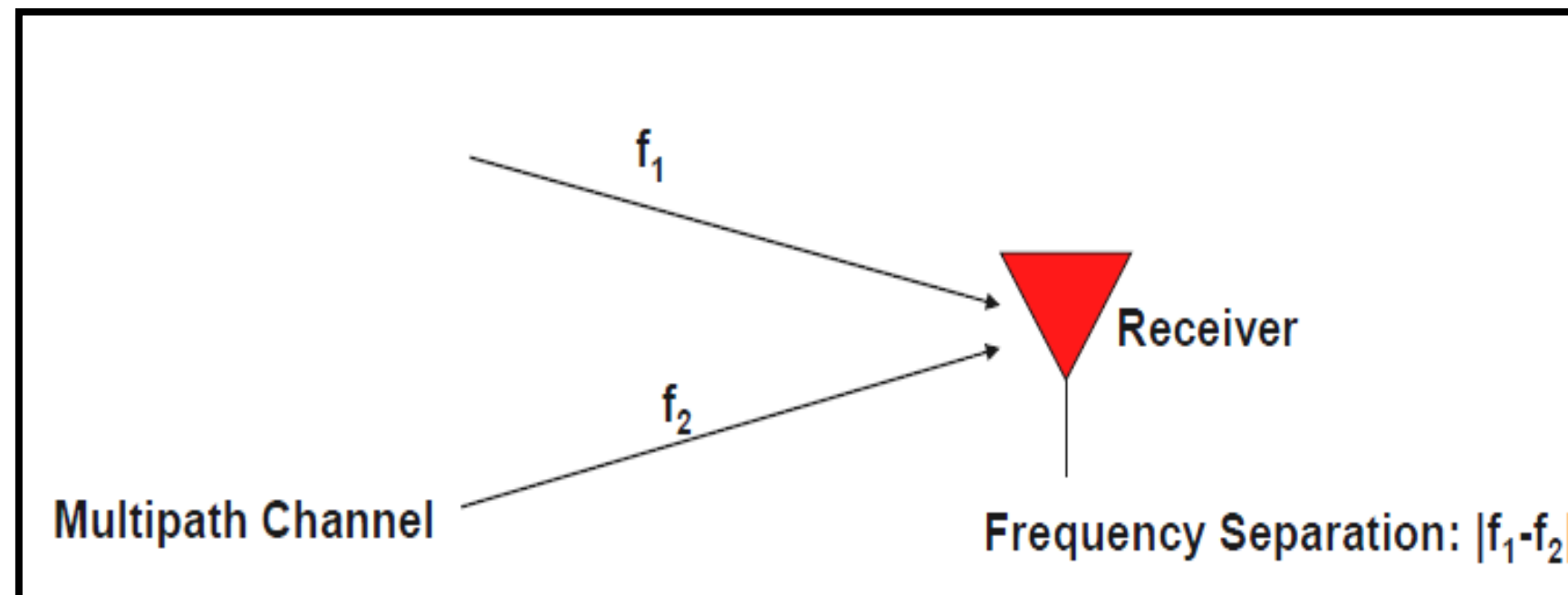



Timer Dispersion Parameters



- Determined from a power delay profile

First moment of the power delay profile

$$\text{Mean excess delay } (\bar{\tau}) \quad \bar{\tau} = \frac{\sum_k a_k^2 \tau_k}{\sum_k a_k^2} = \frac{\sum_k P(\tau_k) \tau_k}{\sum_k P(\tau_k)}$$

The rms delay spread is the square root of the second central moment of the power delay profile

$$\text{Rms delay spread } (\sigma_\tau) \quad \sigma_\tau = \sqrt{\bar{\tau}^2 - (\bar{\tau})^2}$$

Square root of the second central moment of the power delay profile

$$\bar{\tau}^2 = \frac{\sum_k a_k^2 \tau_k^2}{\sum_k a_k^2} = \frac{\sum_k P(\tau_k) \tau_k^2}{\sum_k P(\tau_k)}$$



Doppler Spread and Coherence time



- **Delay spread** and **Coherence bandwidth** describe the time dispersive nature of the channel in a local area
- They don't offer information about the time varying nature of the channel caused by relative motion of transmitter and receiver
- **Doppler Spread** and **Coherence time** are parameters which describe the time varying nature of the channel in a small-scale region.
- Time varying nature of channel caused either by relative motion between BS and mobile or by motions of objects in channel are categorized by B_D and T_c



Doppler Spread



- Measure of spectral broadening caused by motion
- To compute Doppler shift: f_d
- Doppler spread, B_D , is defined as the maximum Doppler shift: $f_m = v/\lambda$
- if Tx signal bandwidth (B_s) is large such that $B_s \gg B_D$ then effects of Doppler spread are **NOT** important
- So Doppler spread is only important for low data rate applications (e.g. paging) slow fading channel

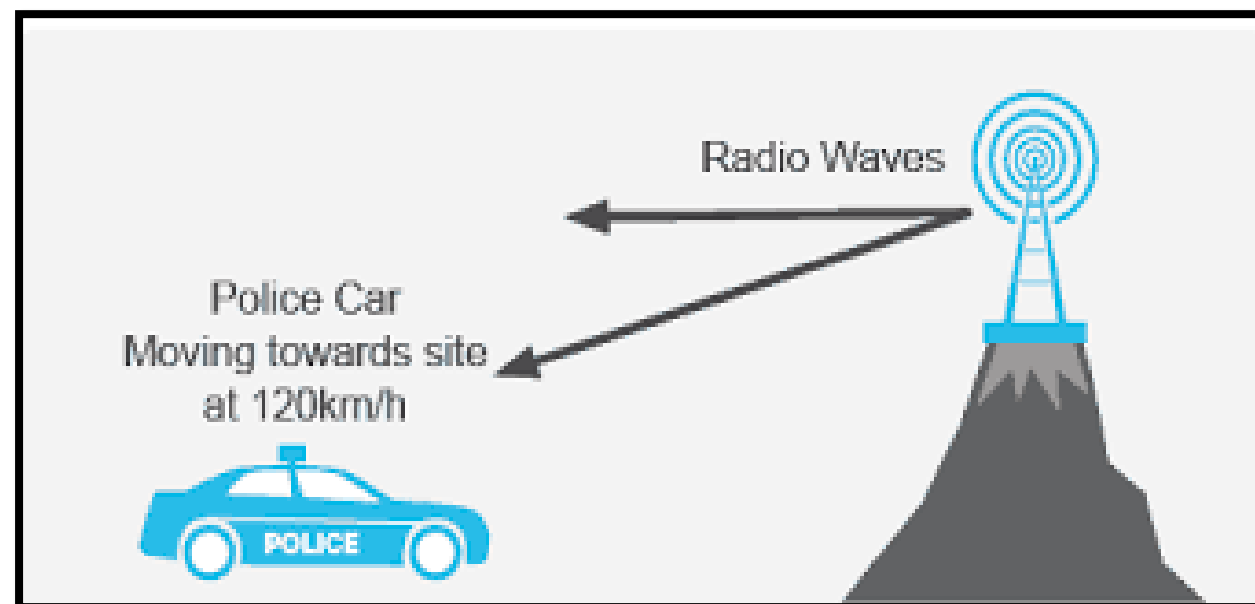



Coherence Time



- ❑ Coherence time is the time duration over which the channel impulse response is essentially invariant.
- ❑ If the symbol period of the baseband signal (reciprocal of the baseband signal bandwidth) is greater than the coherence time, then the signal will distort, since the channel will change during the transmission of the signal.

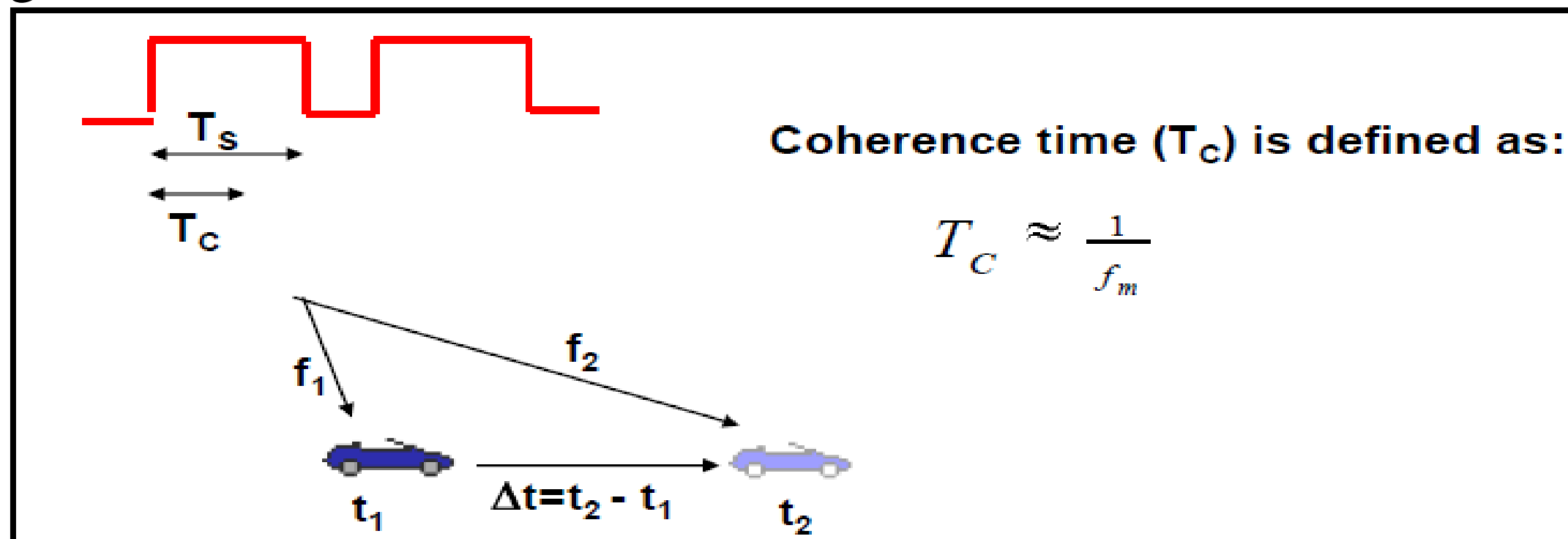



Coherence Time



- Coherence time is also defined as:

$$T_c \approx \sqrt{\frac{9}{16\pi f_m^2}} = \frac{0.423}{f_m}$$

- Coherence time definition implies that two signals arriving with a time separation greater than T_c are affected differently by the channel.



THANK YOU