



SNS COLLEGE OF TECHNOLOGY



AN AUTONOMOUS INSTITUTION

**Approved by AICTE New Delhi & Affiliated to Anna University Chennai
Accredited by NBA & Accredited by NAAC with “A+” Grade, Recognized by UGC**

COIMBATORE

DEPARTMENT OF CIVIL ENGINEERING

19CEB201 – CONSTRUCTION MATERIALS

II YEAR / III SEMESTER

Unit 3 : Concrete

Topic 7 : Tests on Fresh Concrete



Tests on Fresh Concrete



Test on Workability:

- The workability of concrete is decided during mix proportioning based on the type of compaction method available and construction techniques used at site.
- Majority of concretes are used in general civil construction sites where compaction is done either through needle vibrator or surface/screed vibrator, the workability of concrete in terms of slump is kept within 50 mm to 100 mm.



Tests on Fresh Concrete



➤ However, the situation may arise where workability requirements differ and to meet different requirements, workability is tested by other methods also.

- Slump Cone Test
- Compaction Factor Test
- Flow Test
- Vee-Bee Consistometer Test
- Kelly Ball Test



Slump Cone Test



Slump test:

- It is the most common test performed on fresh concrete used to measure consistency.
- Though it does not measure all the factors contributing to workability, it is used as a control test as it gives an indication of the uniformity of the concrete from batch to batch.
- Information on the workability and quality of concrete can be obtained by observing the manner in which concrete slumps.
 - It can be performed on both field and lab
 - It is not suitable for very wet or dry mixes (for very dry mixes compacting factor test is recommended and for very wet mixes flow test is recommended)



Slump Cone Test

Apparatus:

The apparatus required for the slump test is shown below. Other than this, a steel tamping with bullet end is used for tamping.

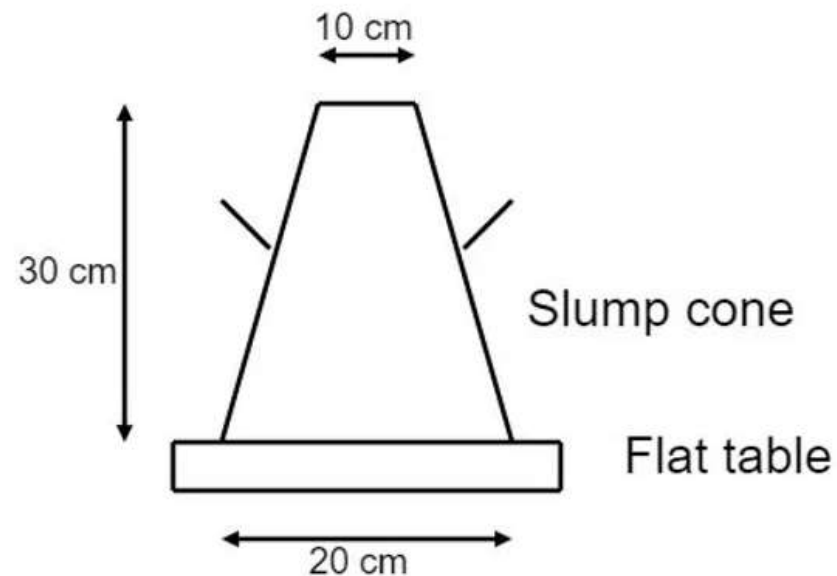

Slump Cone Apparatus



Slump Cone Test

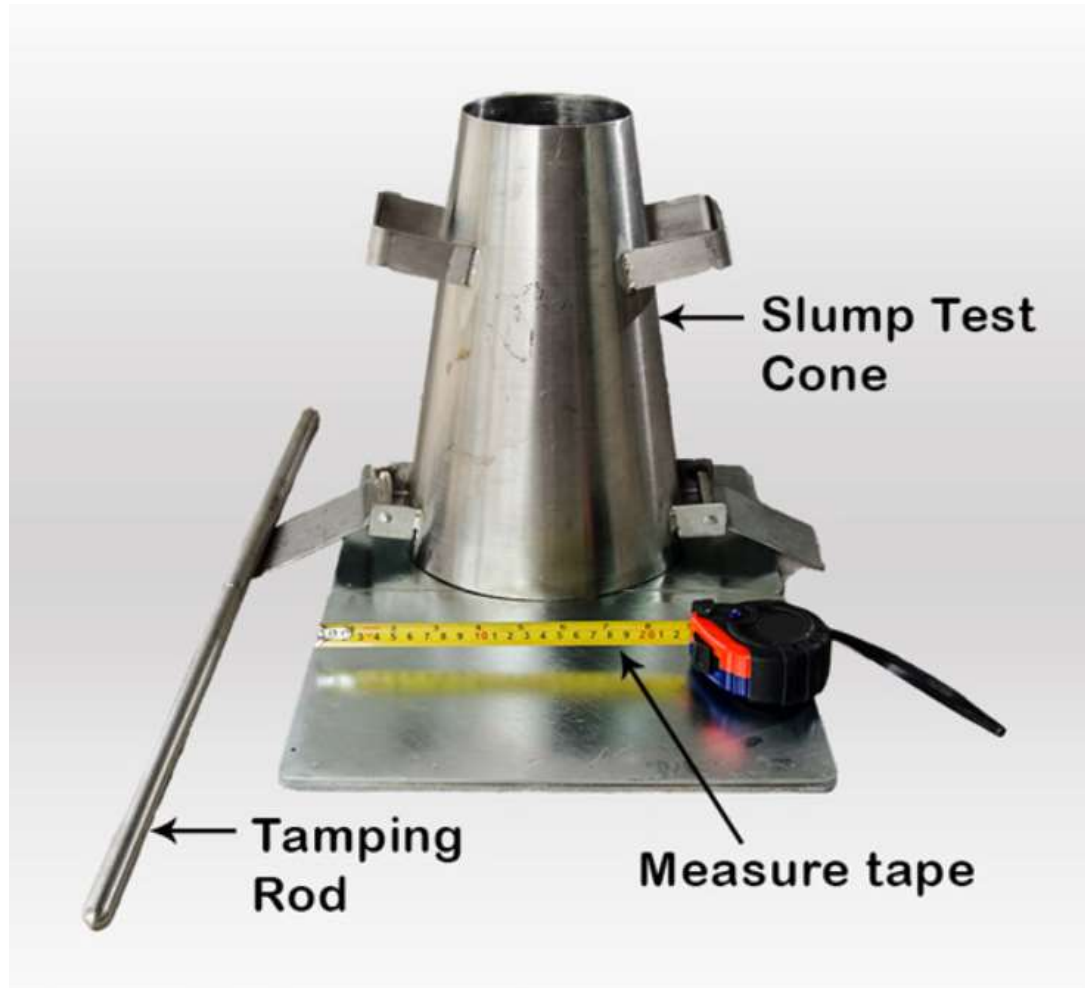



Slump Cone Test



Procedure

- The surface of the mould is cleaned and freed from moisture and adherence of any old concrete
- Mould is then placed on a smooth, horizontal, non-absorbent surface
- The mould is then filled with concrete in 4 equal layers with each layer being tamped 25 times
- After tamping the top layer, the concrete is struck off level with a trowel
- The mould is raised slowly and carefully in a vertical direction immediately after filling with concrete
- Concrete subsides and this subsidence is called the slump of the concrete



Slump Cone Test



- The difference in height of the mould and that of the highest point of the subsided concrete is measured in mm and is called the slump value of concrete
- The pattern of slump indicates the quality of concrete. There are three slump patterns.
 - ✓ True slump - slumps evenly
 - ✓ Shear slump - one half of the cone slides down - indicates non-cohesiveness
 - ✓ Collapse



Slump Cone Test

True slump

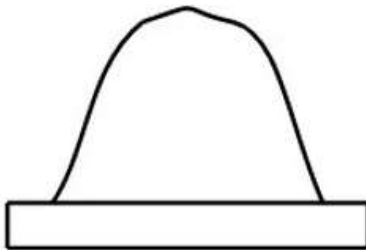

Shear slump

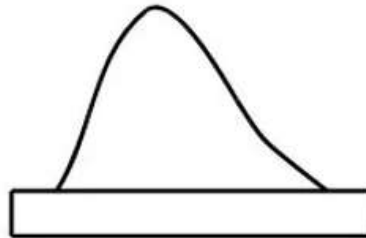

Collapse



Types of Slump



Compacting factor Test



- Compacting test is more precise and sensitive than a slump cone test.
- This test works on the principle of determining the degree of compaction achieved by a standard amount of work done by allowing the concrete to fall through a standard height.
- Then the degree of compaction called the compacting factor is measured by the density ratio i.e., the ratio of the density actually achieved in the test to the density of the same concrete when fully compacted.
 - This test was designed as a laboratory test but can be used in the field as well
 - This test is designed for concrete of very low workability i.e., dry mix



Compacting factor Test

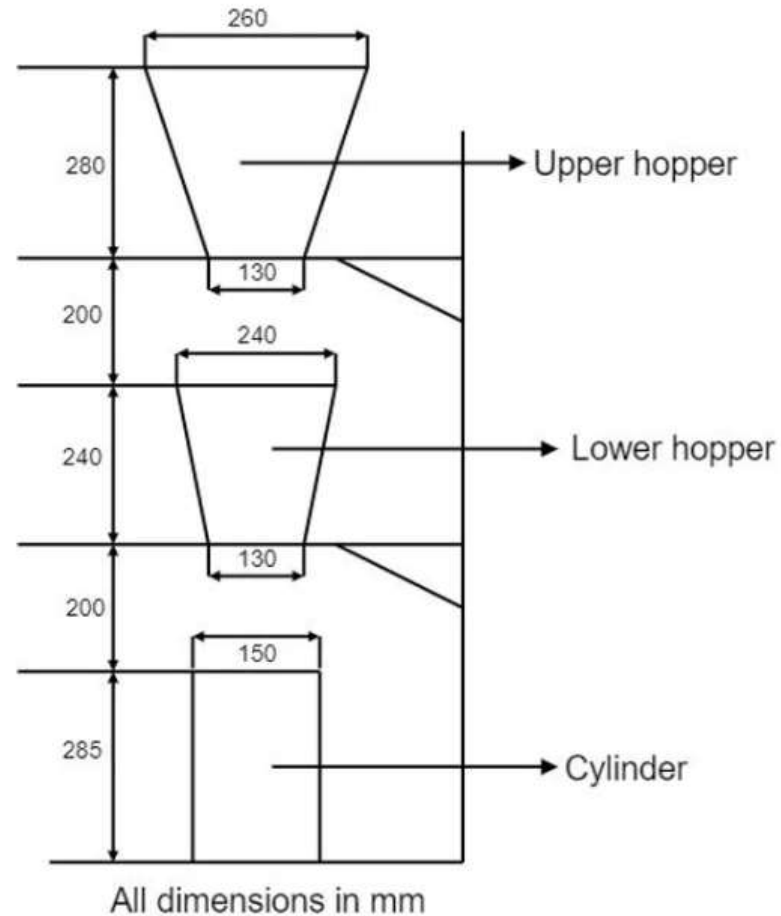

Compacting Factor Test



Compacting factor Test

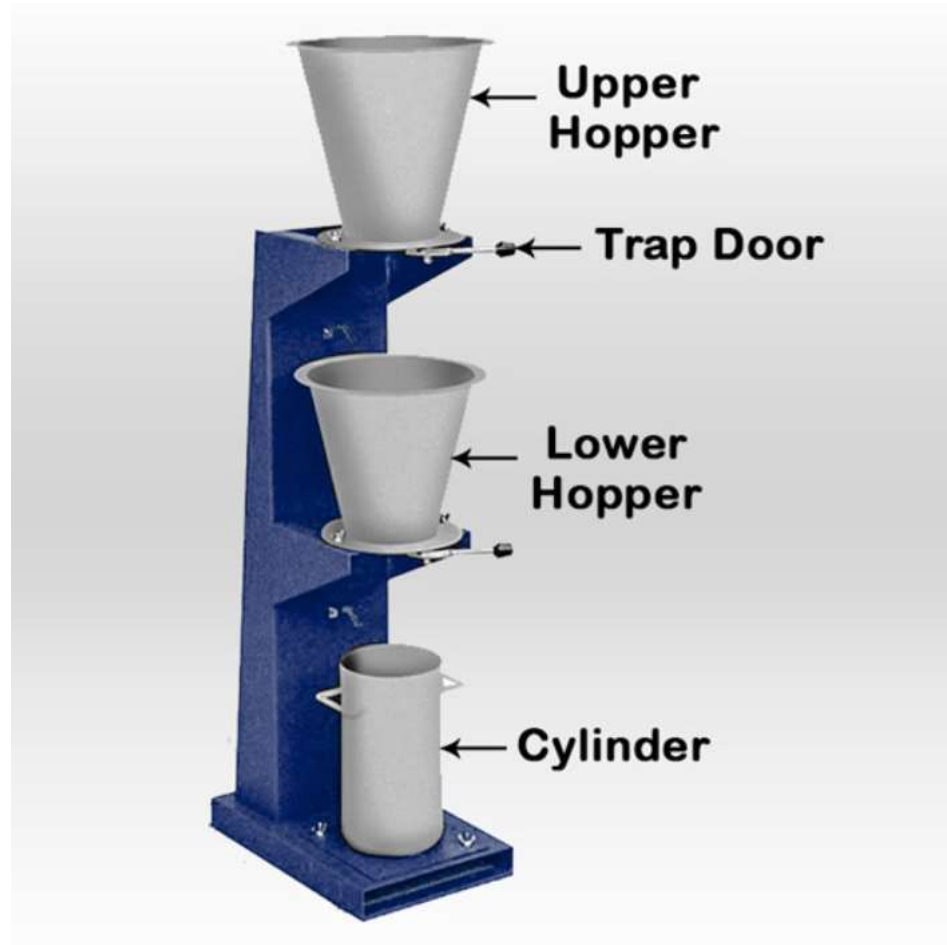



Compacting factor Test



Procedure

- The concrete is placed in the upper hopper up to the brim
- The trap door is opened so that the concrete falls into the lower hopper
- Then the trap door of the lower hopper is opened and the concrete is allowed to fall into the cylinder. Slight poking shall be used to set the dry concrete in motion
- Excess concrete above the top level of the cylinder is removed and the outer surface of the cylinder is wiped
- Concrete along with the cylinder is weighed and this weight is called the weight of the partially compacted concrete



Compacting factor Test



Procedure

- The concrete is removed from the cylinder and is refilled with concrete from the same sample in layers with each layer being heavily rammed or vibrated
- Excess concrete above the top level of the cylinder is removed and the outer surface of the cylinder is wiped
- Concrete along with the cylinder is then weighed and this weight is called the weight of fully compacted concrete
- The compacting factor is then calculated as, compacting factor = $\frac{\text{weight of partially compacted concrete}}{\text{weight of fully compacted concrete}}$



Compacting factor Test

- The compacting factor is then related to the workability of the concrete i.e., a value of 0.78 to 0.8 represents low workability and a value of more than 0.95 represents high workability.
- Compacting factor test measures all the contributing factors to workability and therefore it is one of the good tests to depict workability.



Flow Table Test

- Flow test gives an indication of the quality of concrete with respect to consistency, cohesiveness and the proneness to segregation. In this test, concrete is subjected to jolting and then the spread of concrete is measured and this flow is related to workability.
 - ✓ This test is performed on laboratory
 - ✓ This test is performed for very wet mixes



Flow Table Test

Apparatus

- The apparatus for performing the flow test contains a table with a jolting arrangement, slump cone-like mould apparatus to fill the concrete. A wooden tamping rod is also required.

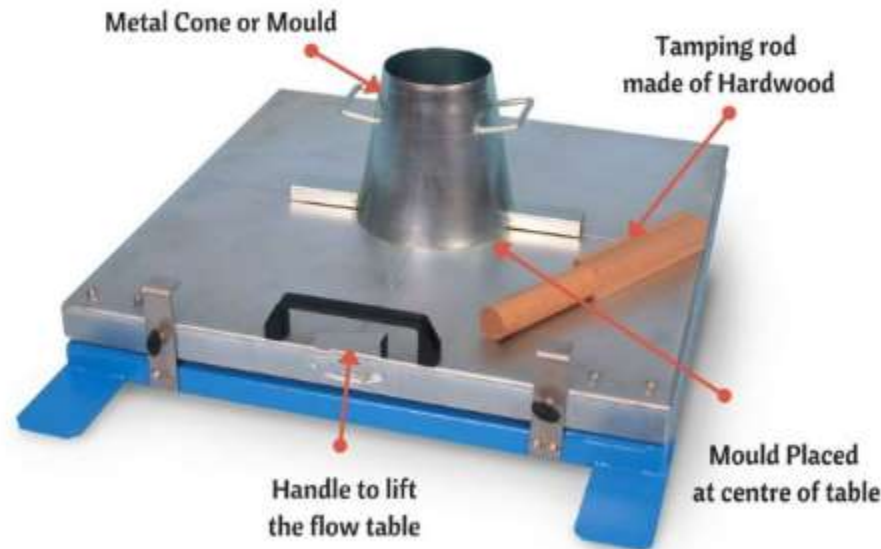



Flow Table Test

Procedure

- The top of the table and mould is cleaned of all gritty materials and is wiped with a damp cloth
- Mould is kept on the centre of the table and is filled in two layers with each layer being tamped 10 times
- The excess concrete is removed from the top of the mould
- The mould is lifted vertically upward after half a minute of removing excess concrete
- Then the top of the table is raised by the handle and allowed to fall 15 times in 15 seconds
- The diameter of the spread concrete is measured in two directions parallel to the table edge and the average spread is noted as flow



Flow Table Test

Procedure

$$\text{Flow\%} = (\text{Spread diameter in cm} - 25) / 25 * 100$$

The value of flow test varies from 0 to 150%.



Vee-Bee Consistometer Test

- Vee bee consistometer test is a good laboratory test on fresh concrete to measure the workability in an indirect way by using a Vee-Bee consistometer.
- Vee bee test is usually performed on dry concrete and it is not suitable for very wet concrete.
- Vee bee consistometer test determines the mobility and to some extent compatibility of concrete.
- In the vee bee consistometer test vibrator is used instead of jolting.
- Vee bee test determines the time required for the transformation of concrete by the vibration.



Vee-Bee Consistometer Test





Vee-Bee Consistometer Test

- Slump test as described in "IS 1199:1959 Specifications for Concrete Slump Test Apparatus (Fourth revision). Reaffirmed- Dec 2013". is performed, placing the slump cone inside the sheet metal cylindrical pot of the consistometer.
- The glass disc attached to the swivel arm shall be moved and placed just on the top of the slump cone in the pot and before the cone is lifted up, the position of the concrete cone shall be noted by adjusting the glass disc attached to the swivel arm. The cone shall then be lifted up and the slump noted on the graduated rod by lowering the glass disc on top of the concrete cone. The electrical vibrator shall then be switched on and the concrete shall be allowed to spread out in the pot.
- The vibration is continued till such a time as the conical shape of the concrete disappears and the concrete assumes a cylindrical shape. This can be judged by observing the glass disc from the top for disappearance of transparency.



Vee-Bee Consistometer Test



- Immediately when the concrete fully assumes a cylindrical shape, the stop watch is switched off. The time required for the shape of concrete to change from slump cone shape to cylindrical shape in seconds is known as Vee Bee Degree.
- This method is very suitable for very dry concrete whose slump value cannot be measured by Slump Test, but the vibration is too vigorous for concrete with a slump greater than about 50 mm.



Vee-Bee Consistometer Test

- **Slump value** = Initial Reading on the graduated scale (a) – Final Reading on the graduated scale (b)
- Consistency of concrete is measured in **Vee Bee Seconds**

Description	Vee-Bee Seconds
Extremely Dry	32-18
Very Stiff	18-10
Stiff	10-5
Stiff Plastic	5-3
Plastic	3-0



Vee-Bee Consistometer Test



Recommended Result of Vee Bee Consistometer Test

According to 'IS 1199:1959' (Methods of Sampling and Analysis of Concrete),

- If vee bee time is up to 20 to 15-10 seconds than concrete is considered as in a very dry consistency.
- If vee bee time is up to 10 to 7-5 seconds than concrete is considered as in a dry consistency.
- If vee bee time is up to 5 to 4-3 seconds than concrete is considered as in a plastic consistency.
- If vee bee time is up to 3 to 2-1 seconds than concrete is considered as in a semi-fluid consistency.



Kelly Ball Test

- This test is developed by J.W Kelly, hence it's known as a Kelly ball test.
- Kelly ball test is a simple and inexpensive field test which measures workability of fresh concrete with the similar to the concrete slump test, but it is more accurate and faster than a slump test.
- This test uses a device that consist of metal hemisphere (ball) thereby indicating the consistency of fresh concrete by its level of penetration when the metal hemisphere drops.
- Thus, in this test, depth is determined through metal hemisphere, which sinks under its own weight into fresh concrete.



Kelly Ball Test

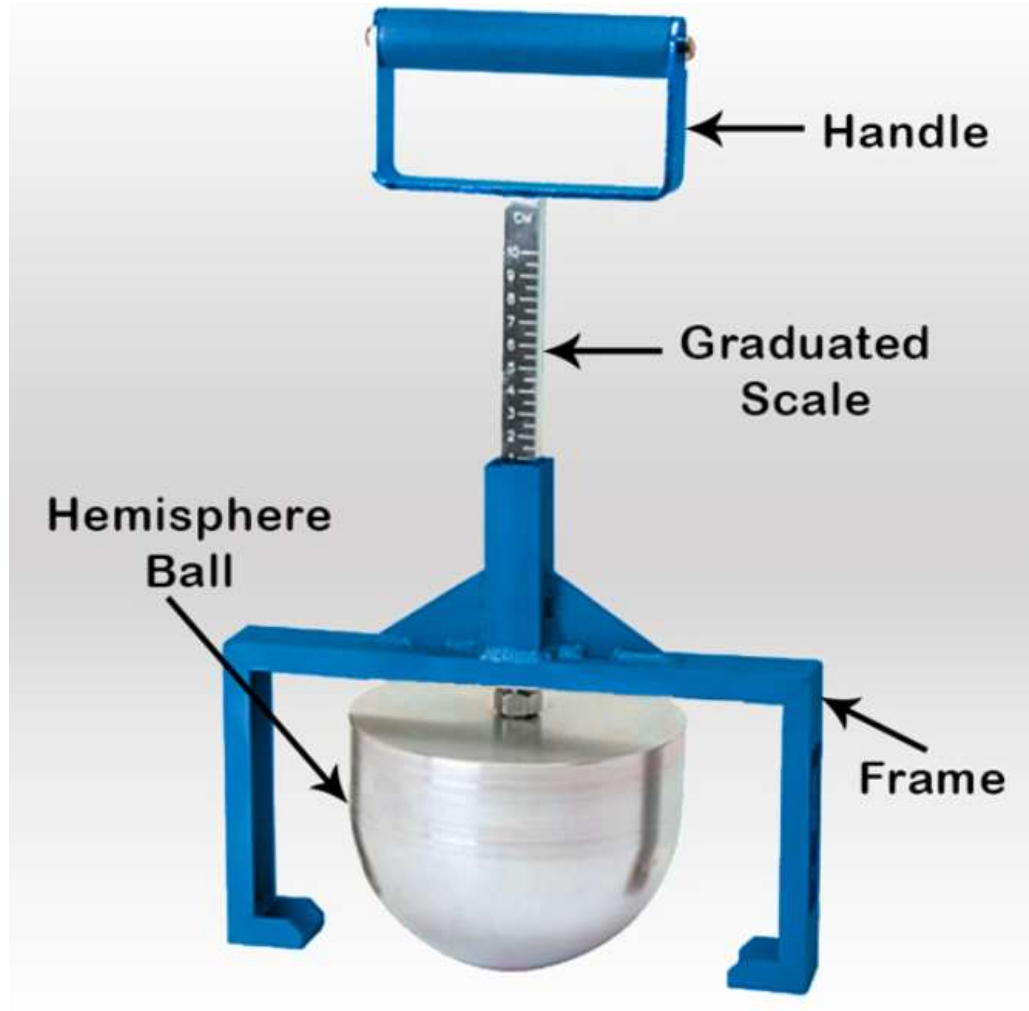



Kelly Ball Test





Thank You!!