



SNS COLLEGE OF TECHNOLOGY

(An Autonomous Institution)

COIMBATORE-35

Accredited by NBA-AICTE and Accredited by NAAC – UGC with A+ Grade
Approved by AICTE, New Delhi & Affiliated to Anna University, Chennai



19EET101 / BASICS OF ELECTRICAL AND ELECTRONICS ENGINEERING I YEAR / I SEMESTER

UNIT-II: ELECTRICAL MACHINES

SINGLE PHASE INDUCTION MOTOR



TOPIC OUTLINE



- ✓ Construction
- ✓ Working Principle
- ✓ TYPES
- ✓ Applications

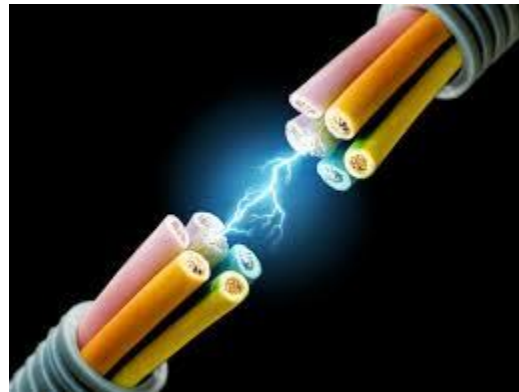

Construction of Single-Phase Induction Motor



The single-phase motors are more preferred over a three-phase induction motor for domestic, commercial applications. Because from utility, only single-phase supply is available.

A single phase induction motor is similar to the three phase squirrel cage induction motor except there is single phase two windings (instead of one three phase winding in 3-phase motors) mounted on the stator and the cage winding rotor is placed inside the stator which freely rotates with the help of mounted bearings on the motor shaft.

Single-phase induction motor also has two main parts;

Stator

Rotor





Principle of Operation



Construction of Single-Phase Induction Motor

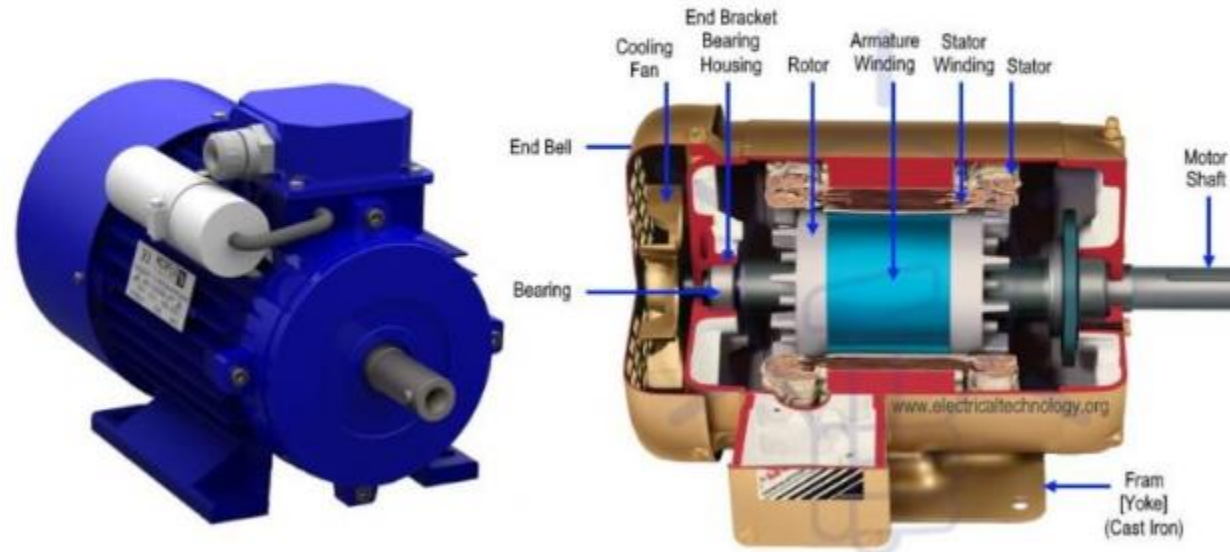



Basic Construction:-



Stator

In stator, the only difference is in the stator winding. The stator winding is single-phase winding instead of three-phase winding. The stator core is the same as the core of the three-phase induction motor.

In a single-phase induction motor, there are two winding are used in stator except in shaded-pole induction motor. Out of these two windings, one winding is the main winding and the second is auxiliary winding.

The stator core is laminated to reduce the eddy current loss. The single-phase supply is given to the stator winding (main winding)





Basic Construction:-

Rotor



www.electricaltechnology.org

Stator

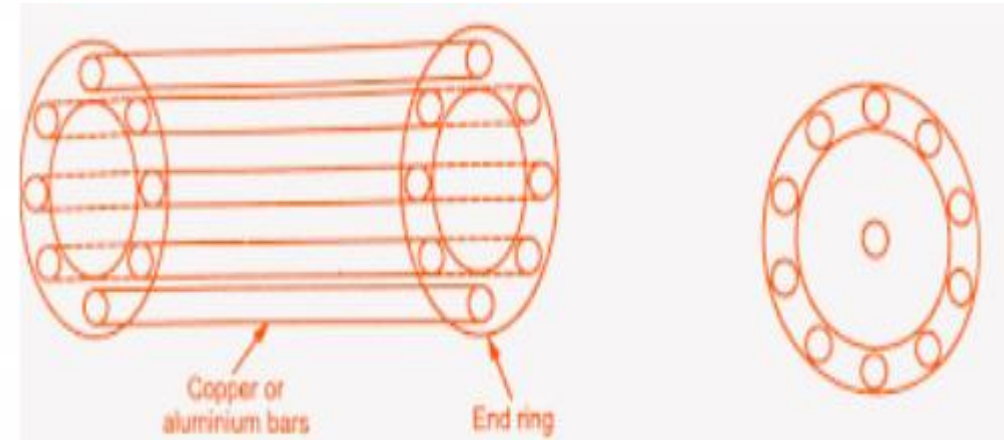



Basic Construction:-



Rotor

Rotor of single-phase induction motor is the same as a rotor of squirrel cage induction motor. Instead of rotor winding, rotor bars are used and it is short-circuited at the end by end-rings. Hence, it makes a complete path in the rotor circuit. The rotor bars are braced to the end-rings to increase the mechanical strength of the motor.

The rotor slots are skewed at some angle to avoid magnetic coupling. And it also used to make a motor run smooth and quiet.





Working of Single-phase Induction Moto



Single-phase AC supply is given to the stator winding (main winding). The alternating current flowing through the stator winding produces magnetic flux. This flux is known as the main flux.

Now we assume that the rotor is rotating and it is placed in a magnetic field produced by the stator winding. According to Faraday's law, the current start flowing in the rotor circuit it is a close path. This current is known as rotor current.

Due to the rotor current, the flux produced around the rotor winding. This flux is known as rotor flux.

There are two fluxes; **main flux which is produced by stator** and second is the **rotor flux which is produced by the rotor**.

Interaction between main flux and rotor flux, the torque produced in the rotor and it starts rotating.

The stator field is alternating in nature. The speed of the stator field is the same as synchronous speed. The synchronous speed of the motor depends on the number of pole and supply frequency.

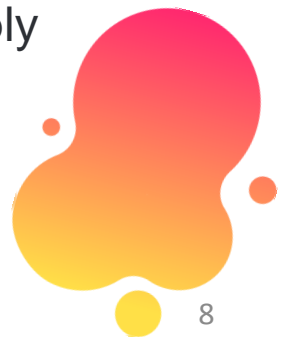



Why Single Phase Induction Motor is not Self Starting?

According to double field revolving theory, we can resolve any alternating quantity into two components. Each component has a magnitude equal to the half of the maximum magnitude of the alternating quantity, and both these components rotate in the opposite direction to each other. For example – a flux, ϕ can be resolved into two components

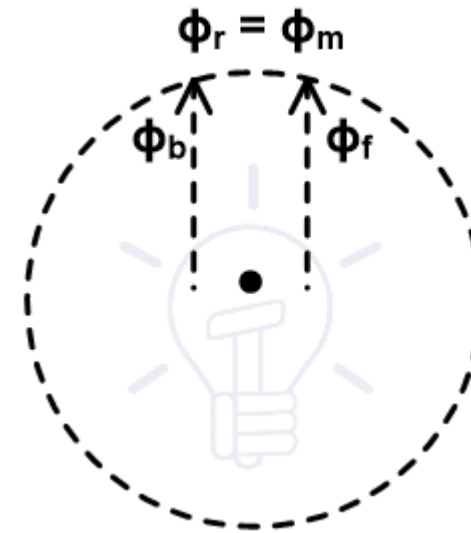
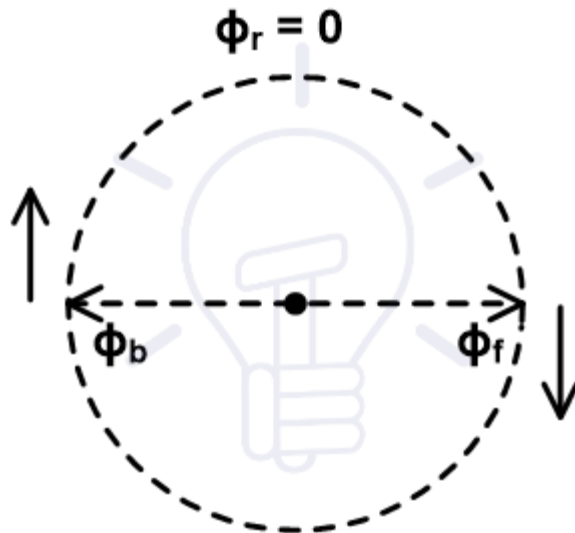



Double field revolving theory



Now at starting condition, both the forward and backward components of flux are exactly opposite to each other. Also, both of these components of flux are equal in magnitude. So, they cancel each other and hence the net torque experienced by the rotor at the starting condition is zero. So, the single phase induction motors are not self-starting motors





Types of single phase induction motor



- ❖ Split phase induction motor,
- ❖ Capacitor start inductor motor,
- ❖ Capacitor start capacitor run induction motor,
- ❖ Shaded pole induction motor.
- ❖ Permanent split capacitor motor or single value capacitor motor.

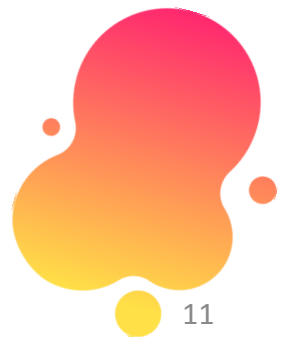

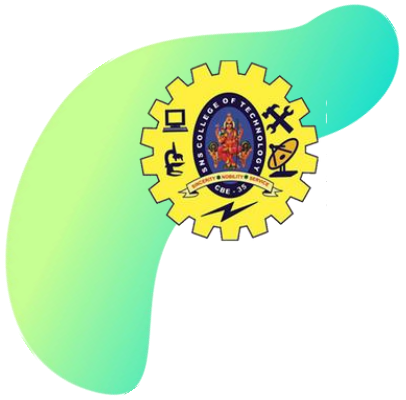

Split Phase Induction Motor

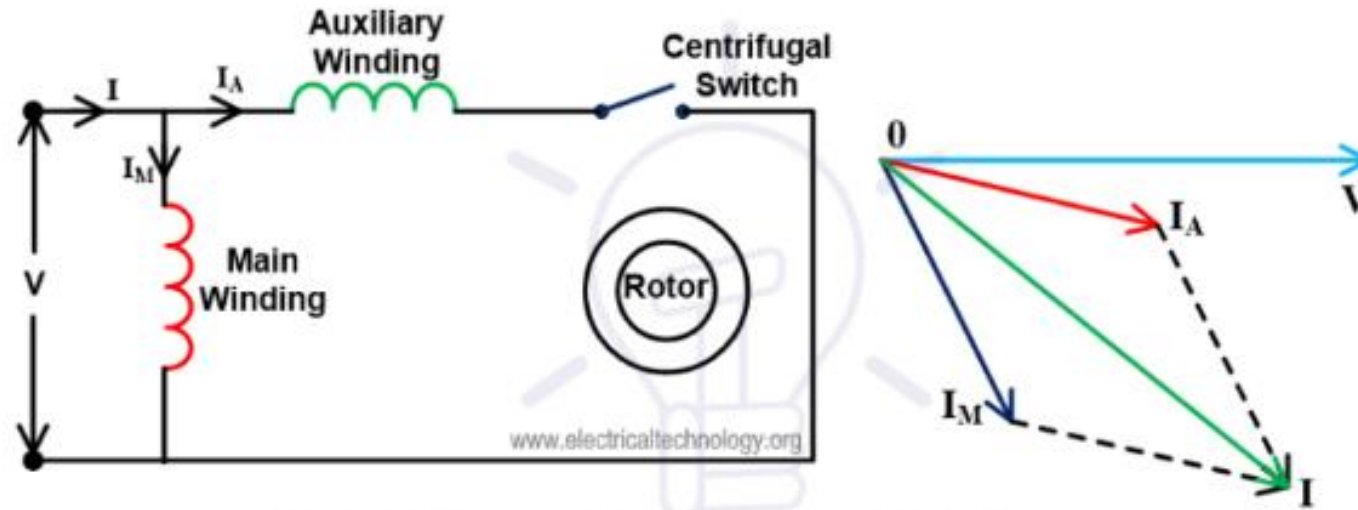

Split Phase Induction Motor



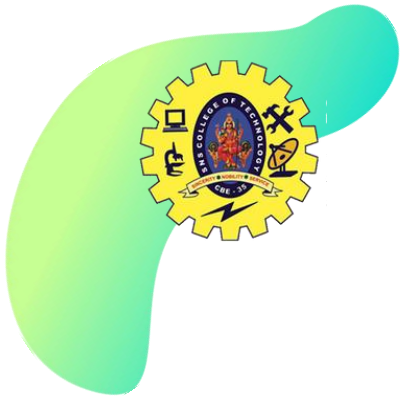

Capacitor Start Induction Motor

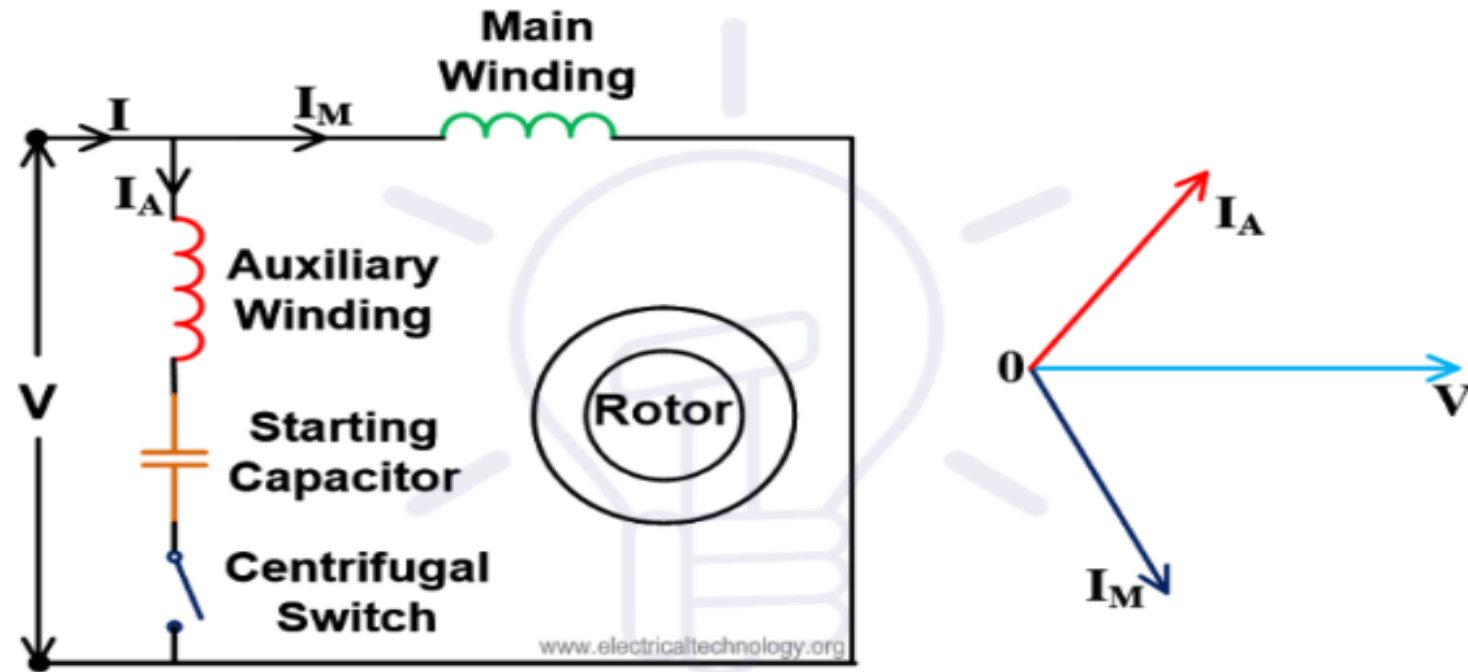

Capacitor Start Induction Motor





Applications of Single Phase Induction Motors



- ✓ Clocks
- ✓ Refrigerators, freezers and heaters
- ✓ Fans, table fans, ceiling fan, exhaust fans, air coolers and water coolers.
- ✓ Blowers
- ✓ Washing machines
- ✓ Machine tools
- ✓ Dryers
- ✓ Type writers, photostats and printers
- ✓ Water pumps and submersible
- ✓ Computers
- ✓ Grinders
- ✓ Drilling machines
- ✓ Other Home instrument, equipment and devices etc.





PRINCIPLE OF OPERATION OF SINGLE PHASE INDUCTION MOTOR Video

<https://www.youtube.com/watch?v=mQ-gPMDv-tl>



RECAP...

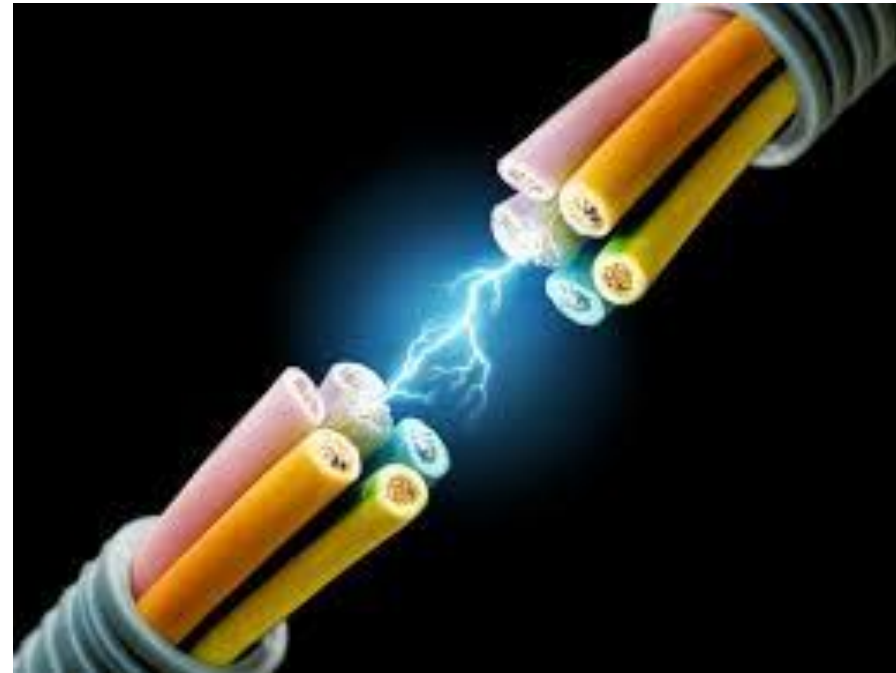

...THANK YOU

