



SNS COLLEGE OF TECHNOLOGY

Coimbatore-35
An Autonomous Institution

Accredited by NBA – AICTE and Accredited by NAAC – UGC with 'A+' Grade
Approved by AICTE, New Delhi & Affiliated to Anna University, Chennai

DEPARTMENT OF MECHATRONICS

19MCB302 -IE- INDUSTRIAL ELECTRONICS III YEAR V SEM

19MCB302 -IE- INDUSTRIAL ELECTRONICS
III YEAR V SEM

UNIT 1 – INTRODUCTION TO POWER ELECTRONICS

TOPIC –BJT

Mr. M.Anand., M.E.,(Ph.D.,)

ASSISTANT PROFESSOR,

DEPARTMENT OF MECHATRONICS,

SNSCT, Coimbatore.





BJT-History





BJT-History





BJT-History



Binary!

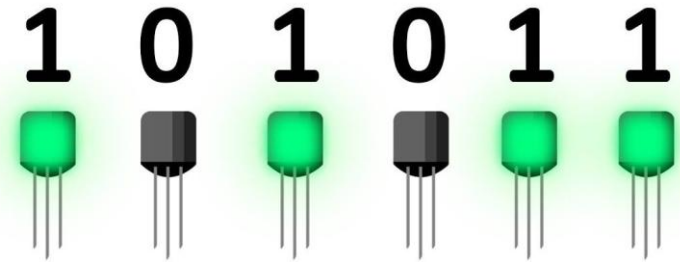



BJT-History

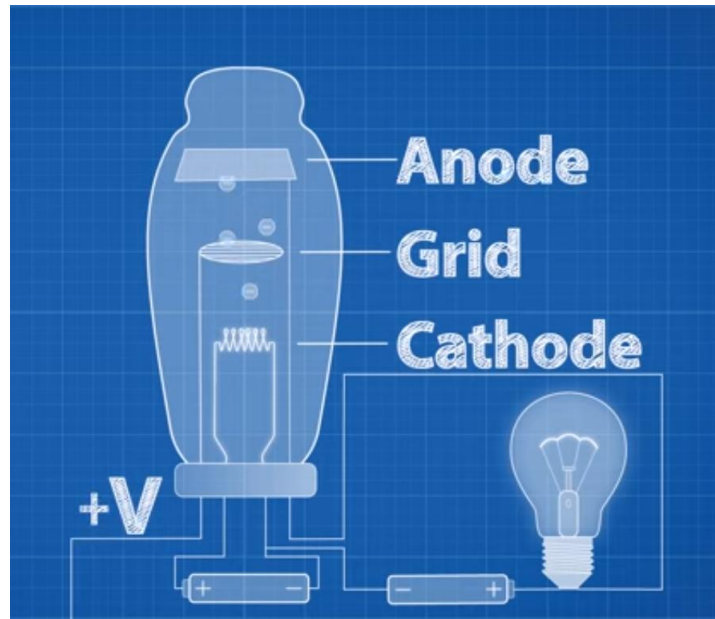
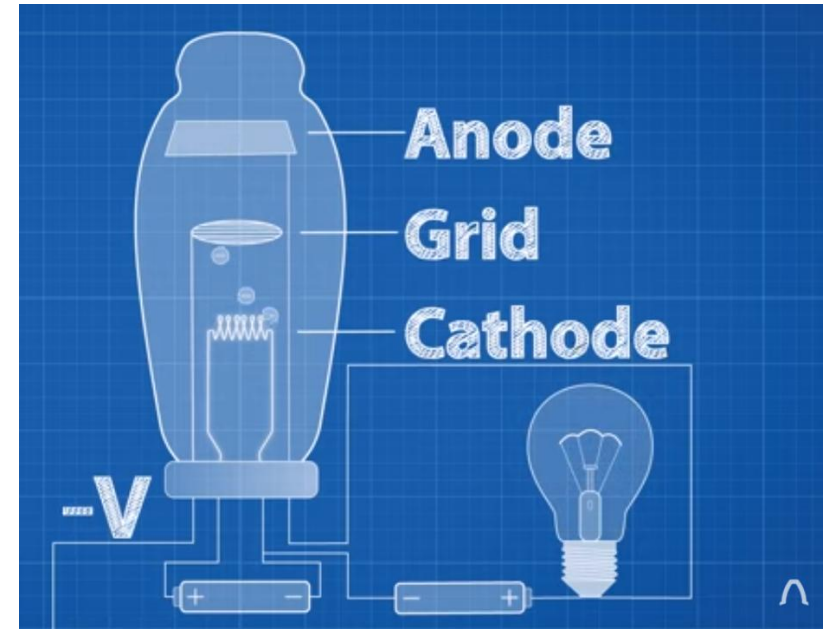
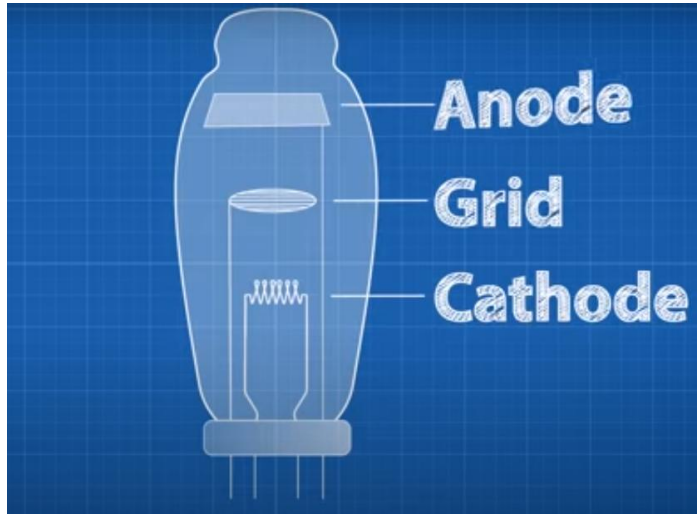



Vaccum tube to BJT



VS

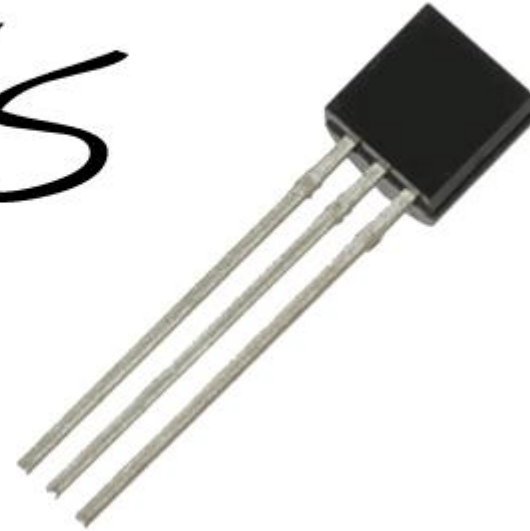



BJT-History

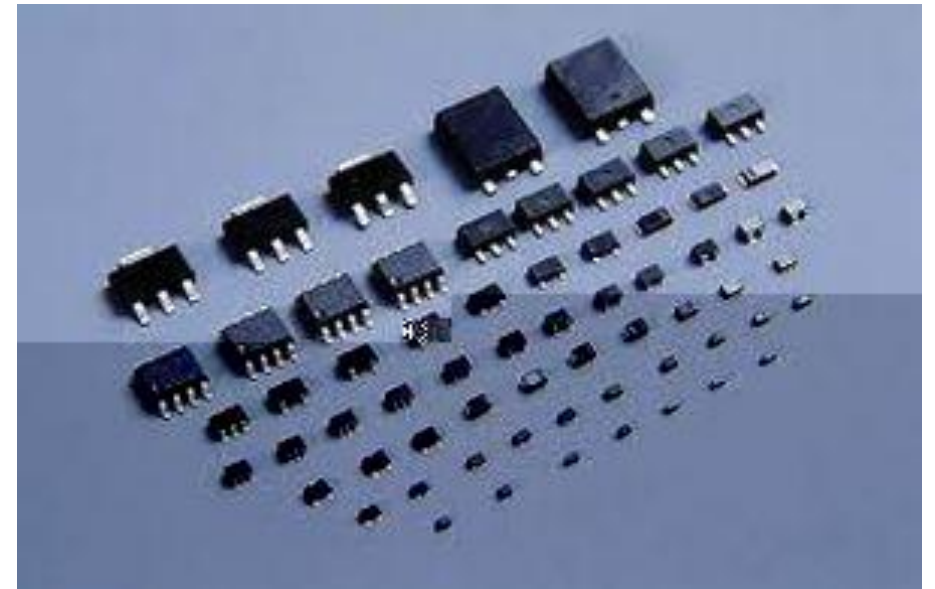
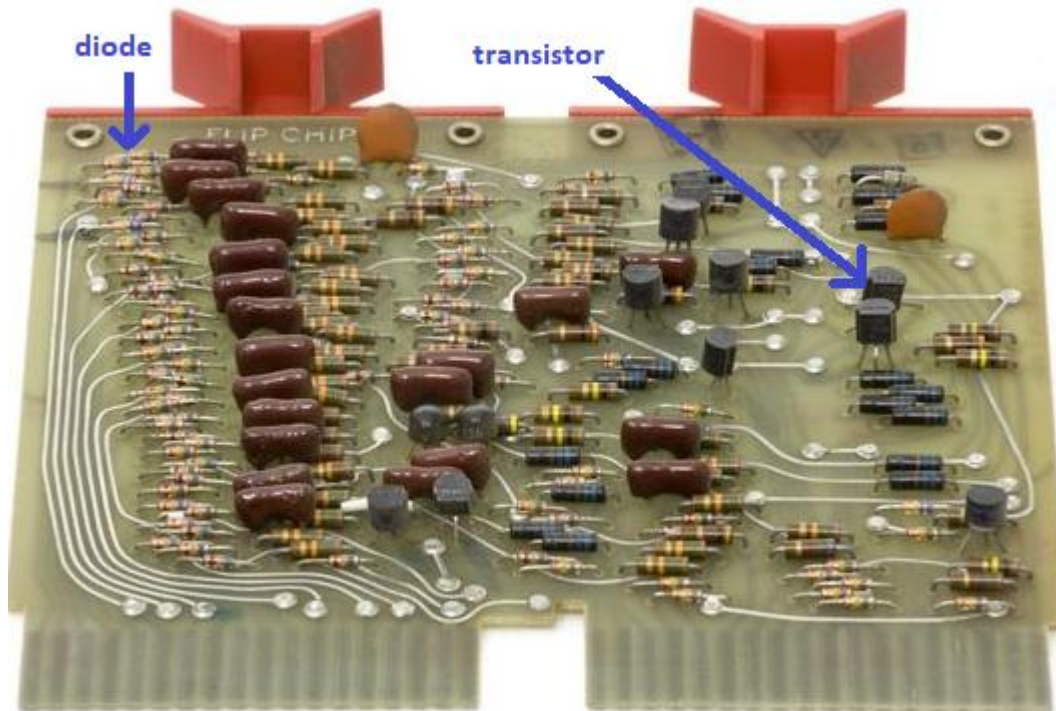



BJT

A **transistor** is a semiconductor device used to amplify or switch ***electronic signals*** and ***electrical power***.

3 Terminal Device

3 layer Device

2 Junction Device

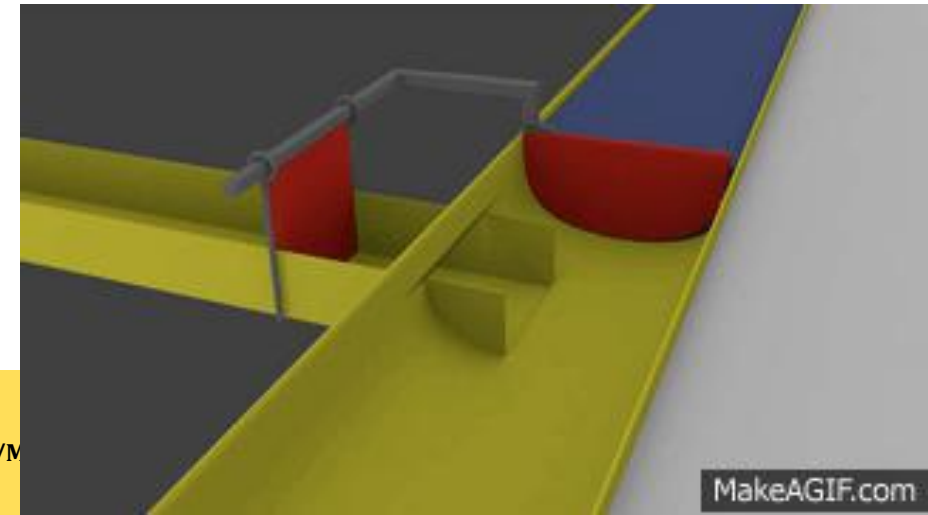
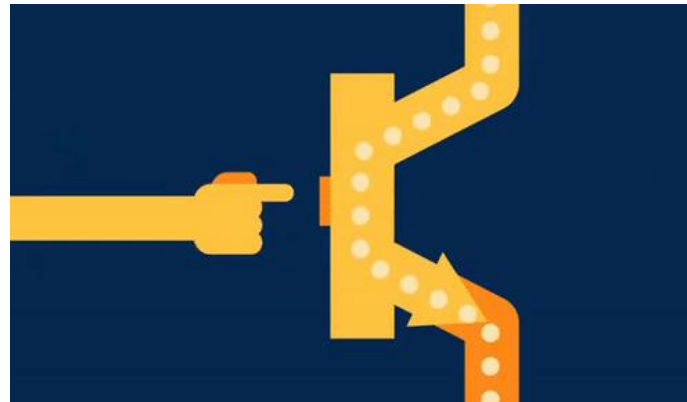



BJT- Basics

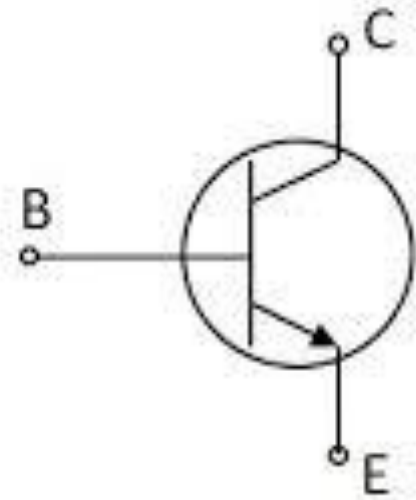



SYMBOL

Layer

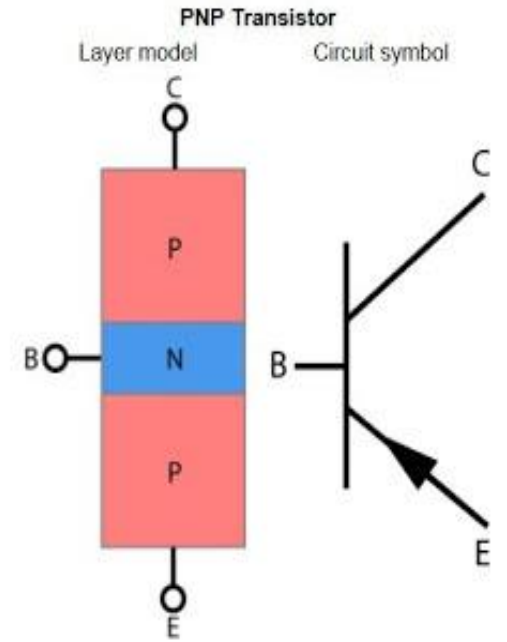
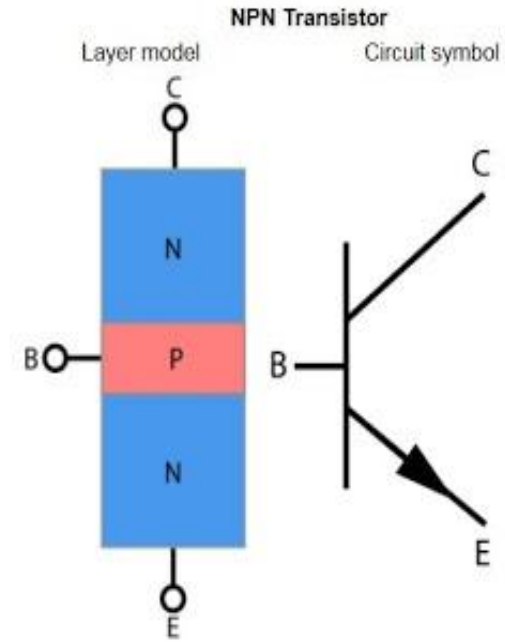
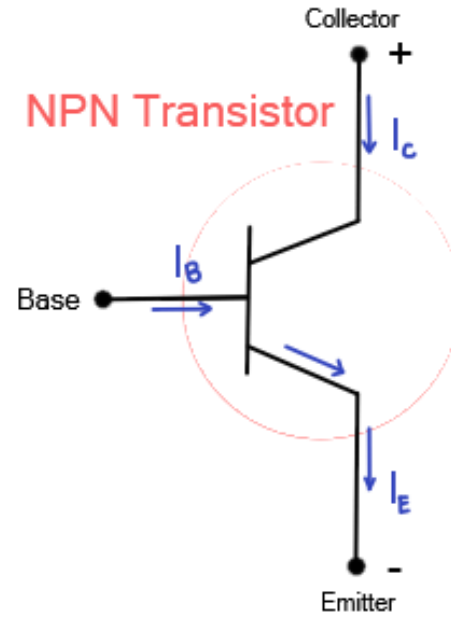
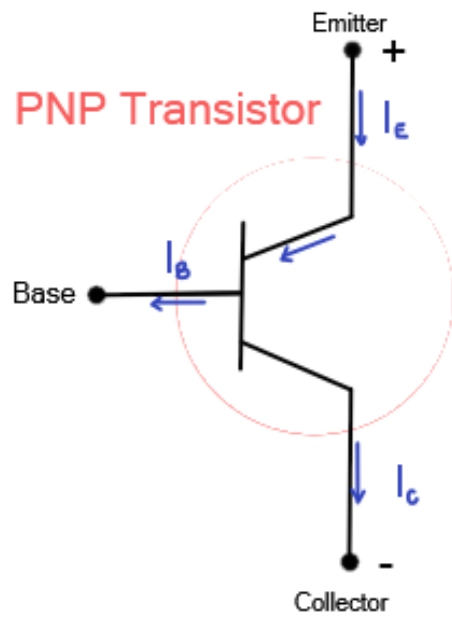



CIRCUIT DIAGRAM

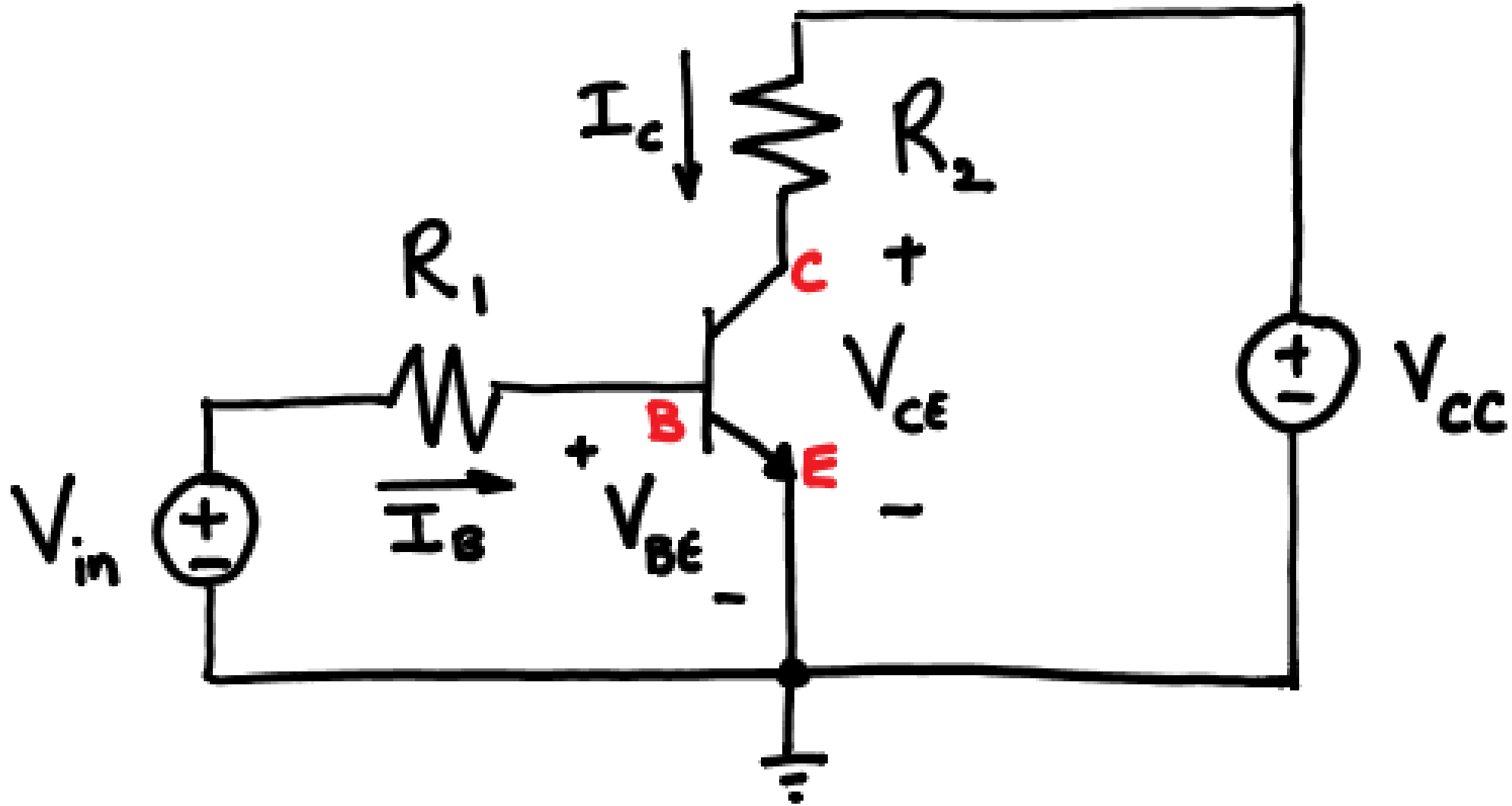



CHARACTERISTIC DIAGRAM

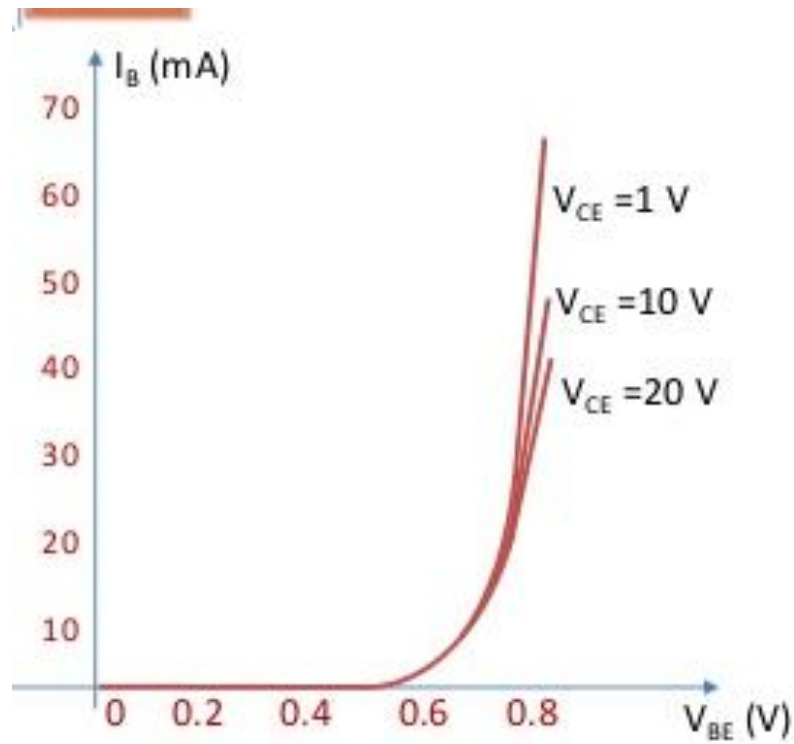

Input characteristics of CE configuration

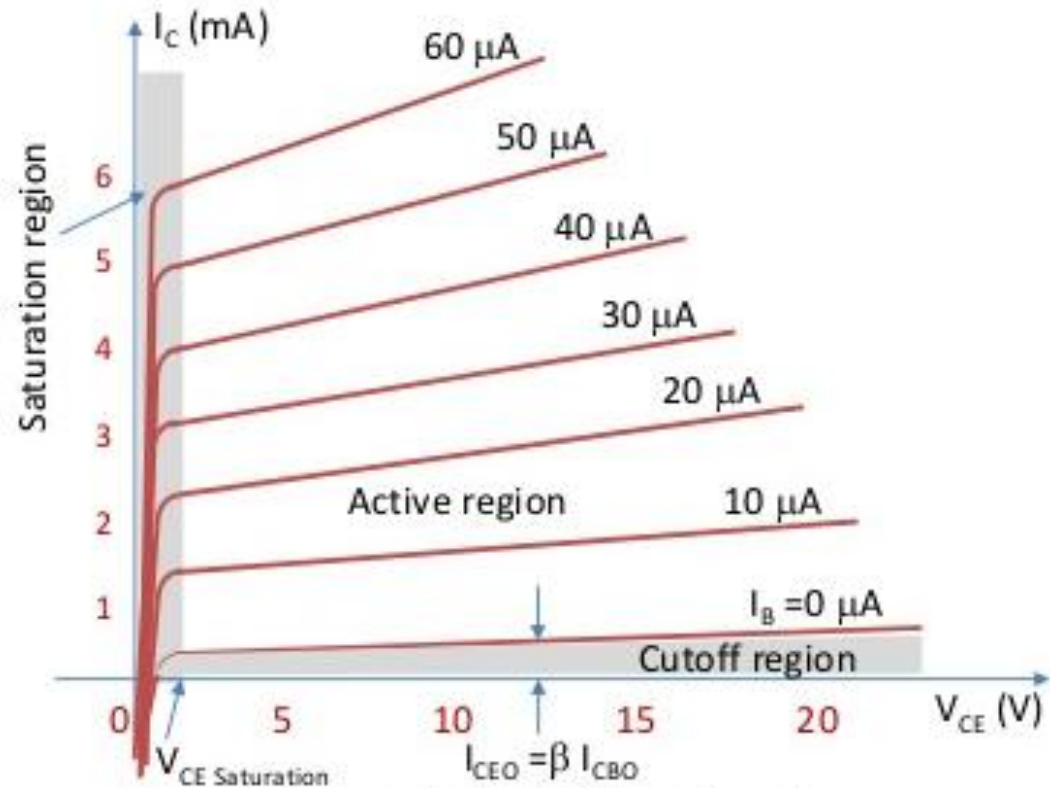

Output characteristics of CE configuration



Advantages of Transistor:

- Lower cost and smaller in size, especially in small-signal circuits.
- Low operating voltages for greater safety, lower costs.
- Extremely long life.
- No power consumption by a cathode heater.
- Fast switching



Applications

- Daily Life Applications
 - Smart Phones
 - CPU, DSP, Controllers
 - Processors
 - CPU, DSP, Controllers
 - Computers
 - Commercial Electronics
 - Medicine
 - Memory chips
 - RAM, ROM, EEPROM
 - Analog
 - Mobile communication, audio/video processing
 - Programmable
 - PLA, FPGA
 - Embedded systems
 - Used in cars, factories
 - Network cards
 - System-on-chip (SoC)





ASSIGNMENT

Test a transistor(Both NPN, PNP) with a multimeter.

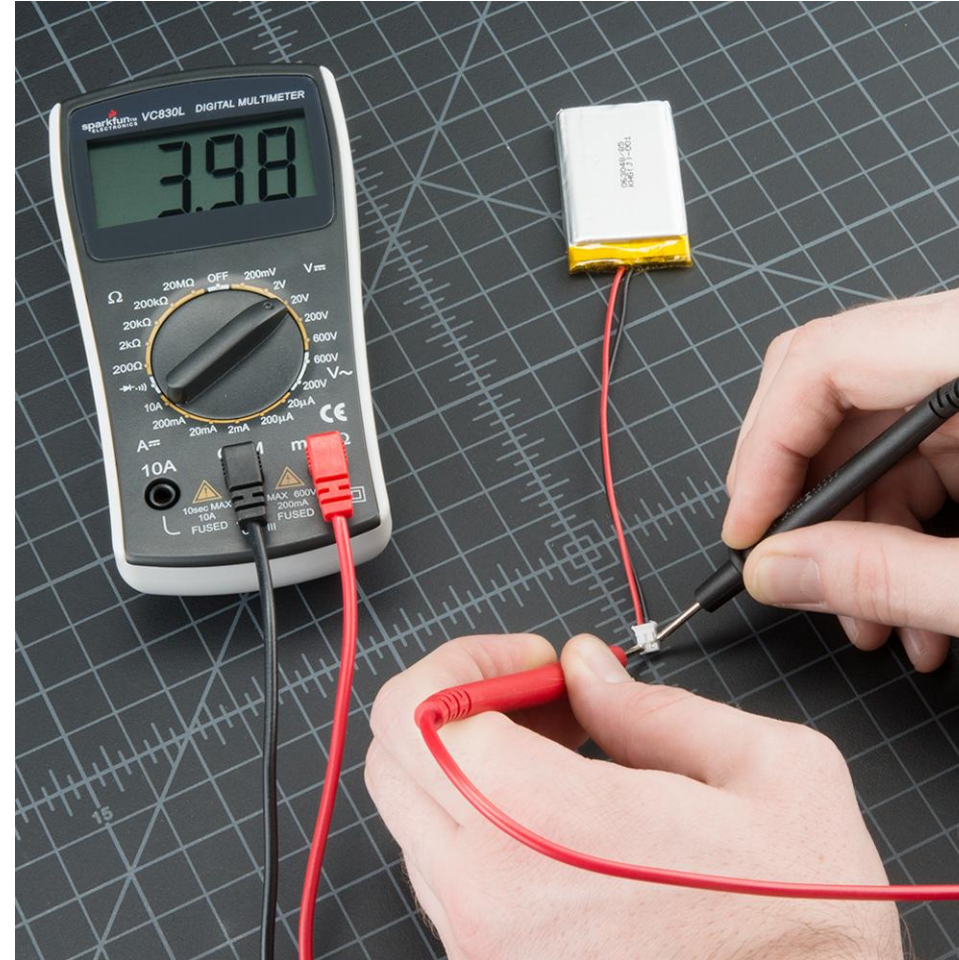



References

1. https://www.electronics-tutorials.ws/transistor/tran_1.html
2. <https://components101.com/articles/understanding-bjt-transistor-and-how-to-use-it-in-your-circuit-designs>
3. <https://www.electrical4u.com/bipolar-junction-transistor-or-bjt-n-p-n-or-p-n-p-transistor/>
4. <https://www.youtube.com/watch?v=-VwPSDQmdjM>
5. <https://www.youtube.com/watch?v=7ukDKVHnac4>

