

Interpreting visual materials

Graphic aids present information in pictorial form or in other specific formats in order to consolidate, clarify, or prove the written material they go with.

The General Strategy for Interpreting Graphs

- ❖ Read the *title*. It usually tells the topic.
- ❖ Look at the *source* of the information.
- ❖ Read any accompanying *explanation*.
- ❖ Read the *legend* (small explanatory table or list of symbols) if there is one.
- ❖ Read the *labels* on the parts of the graph.
- ❖ Determine *what is being measured* or compared and the *units of measurement*.
- ❖ Look for *trends* or patterns.
- ❖ Think about how the graph *illustrates, clarifies, or proves* the material it accompanies.
- ❖ Draw the important *conclusions*.

Five common types of graphic aids are:

- Bar graphs
- Line graphs
- Pie charts
- Tables

Bar Graphs

A **bar graph** is a chart that compares the relative amount of items by using parallel rectangular bars of varying lengths. Bar graphs can be vertical or horizontal.

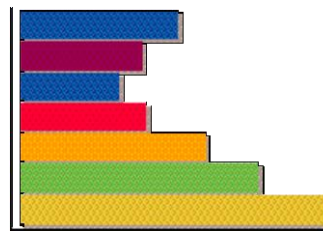
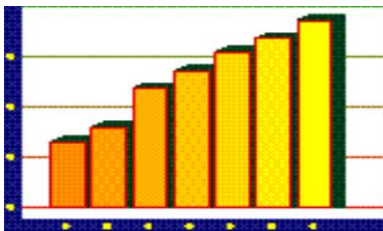

Line Graphs

A **line graph** is a diagram whose points are connected to show the relationship between two or more variables (that is, it shows how one thing changes in relation to a change in something else).

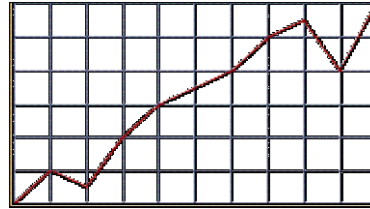
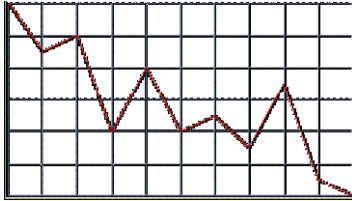

Pie Charts

A **pie chart** is a circle graph that uses various sized “slices” to represent relative parts of the whole.

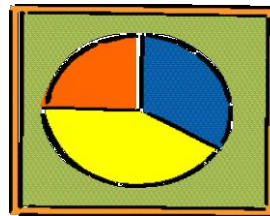
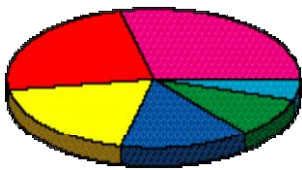

Tables

A **table** shows relationships between facts and figures by arranging information in rows and columns.

- Stop and look at a graphic aid when the author *first* refers to it.
- Watch for *trends* and patterns (a correlation or a consistent increase or decrease).
- To help you organize and learn information, create graphics of your own.

Channel conversion: Flowcharts

A **flowchart** is a diagram that uses connected boxes, circles, and other shapes to show the steps in a

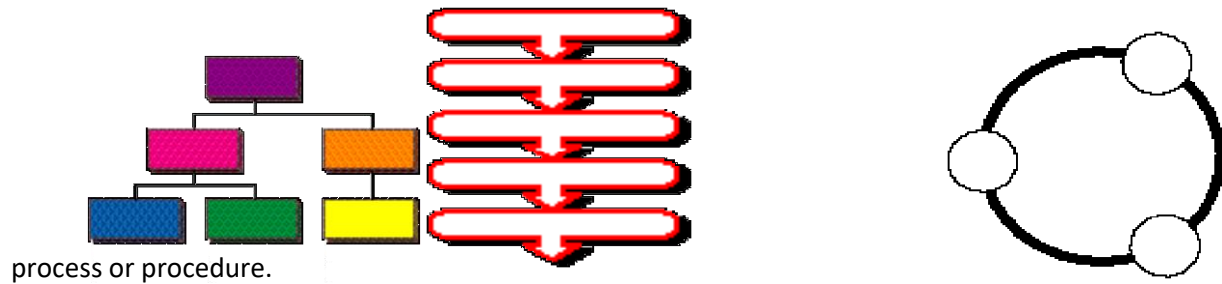

Example 1

1. Convert the following flow-chart into a paragraph of about 150 words. Use an introductory and a concluding sentence with proper sequential expressions and appropriate connectives.

The process of making cement

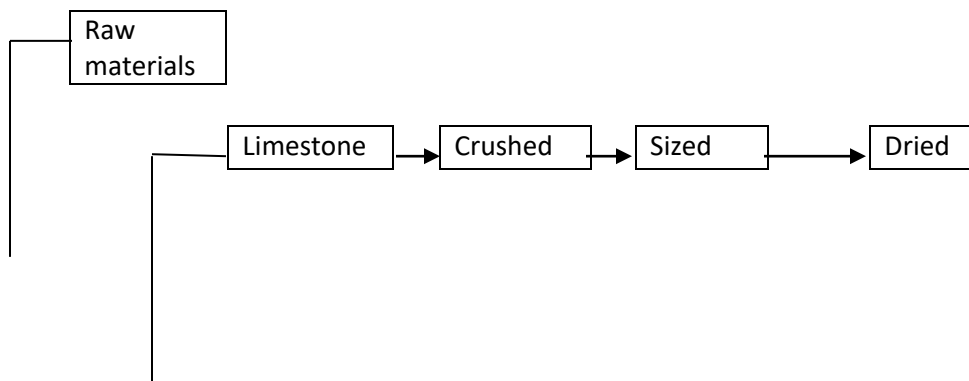

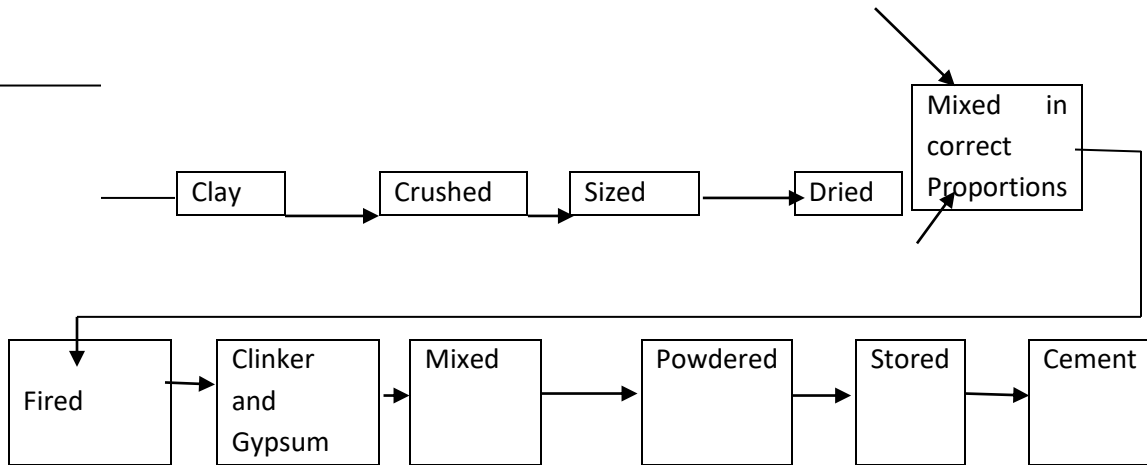

Answer: The process of Making Cement

The flow chart describes the process of making cement. The two raw materials used in the process are limestone and clay. Limestone is crushed, sized and dried. After that, it is stored in the storage silos. Similarly, clay is crushed, sized and stored in the storage basin. The crushed limestone and clay are mixed in correct proportions. The formation is known as slurry. The slurry is fed into the rotary kiln where it is burnt at a higher temperature (1000 to 1700 C). A chemical reaction takes place and clinkers are formed. Now gypsum is added to the clinker. The mixture is powdered and sent to the storage silos. Eventually the finished product is ready in the form of cement. In this way cement is made.

Example 2- Stages in Making cement

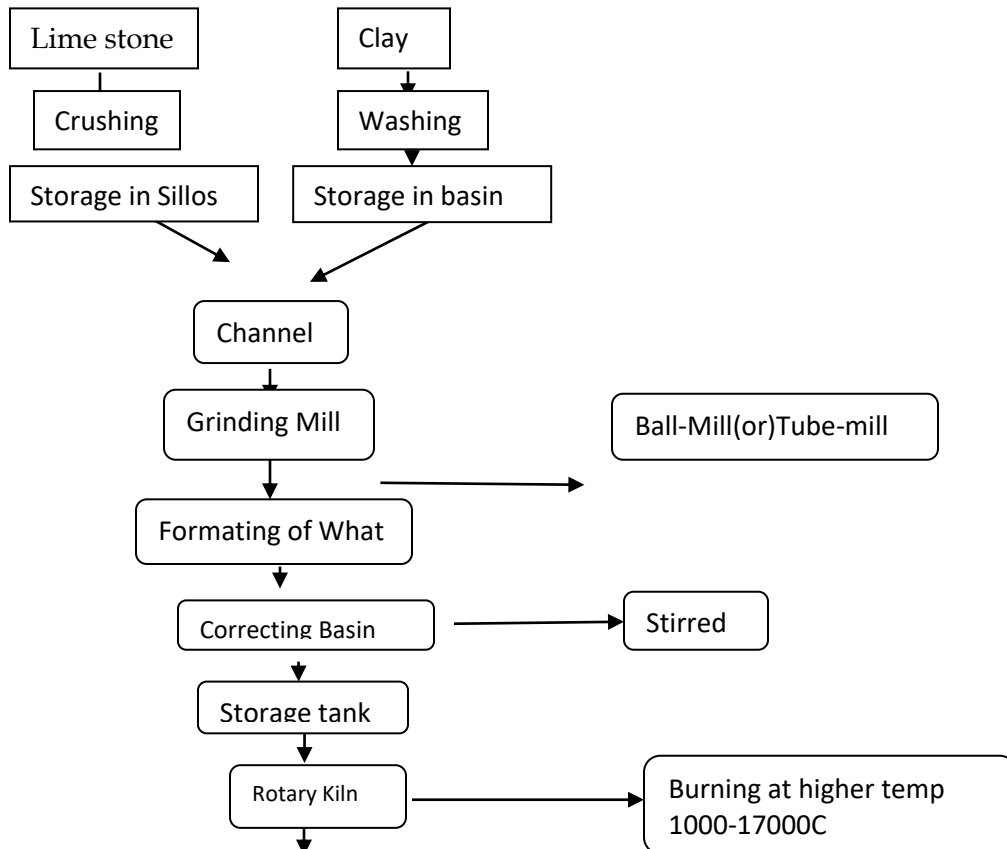

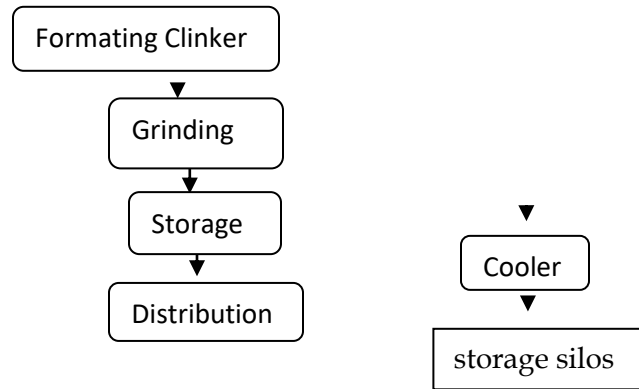

Answer: Stages in Making Cement

This flow chart describes the various stages in making cement. Limestone is crushed and sent to the storage silos. Clay is washed with water and stored in the storage basin. The crushed limestone and clay are mixed in proper proportions and are channelized to a grinding mill where they are ground and the formation is known as slurry. In order to grind, either ball-mill or tube mill is used. The slurry is led to the correcting basin where it is stirred well to ensure the correct composition of the mixture. After that, it is taken to the storage tank. Then it is fed into the rotary kiln where it is burnt at a higher temperature(1000 to 1700 C).Clinkers formed are sent to the cooler. The clinkers are ground and sent to the storage silos. Now the finished product in the form of cement is ready for distribution.

Example 3

Given below is a process description. Read it and draw a flow chart representing the process described.

Rayon is a man-made fibre. It is, infact, a reconstituted natural fibre-cellulose. Rayon is made by dissolving cellulose in a solution of sodium hydroxide, or caustic soda, as it is usually called.The cellulose is obtained from shredded wood pulp.The dissolved cellulose is formed into threads by forcing it through a spinneret in a setting bath of dilute sulphuric acid. The threads are drawn from the setting bath, wound on reel, washed, then dired on a heated roller, and finally wound on to a bottom.

Answer: The process of making Rayon

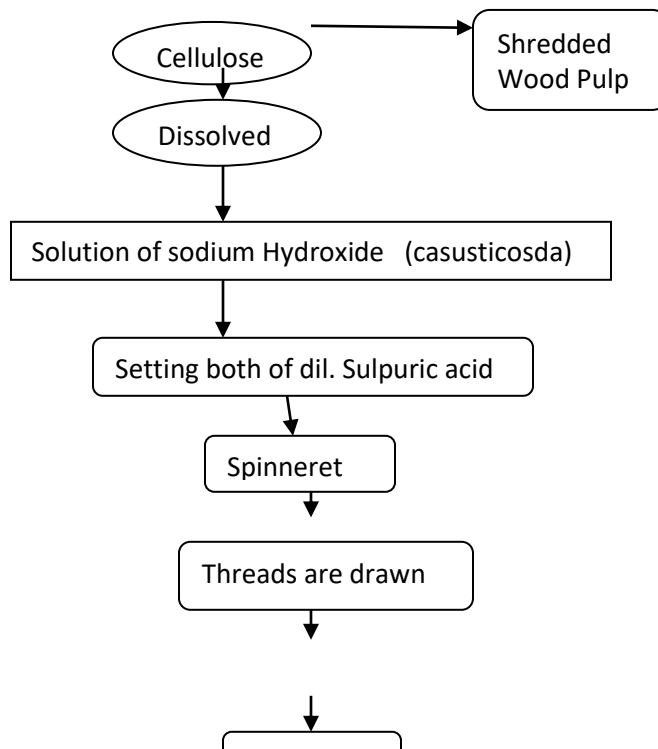

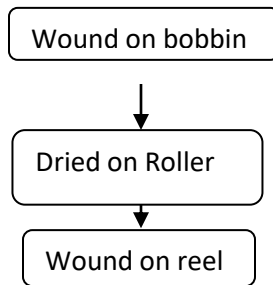

CHANNEL CONVERSION

- Convert the following flow chart into a paragraph of about 150 words. Describe the various steps involved in the purification of water. Use an introductory and a concluding sentence with proper sequential expressions and appropriate connectives.

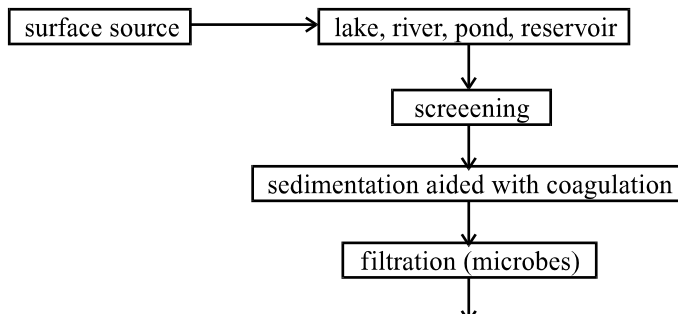

- Given below is a process description. Read it and draw a flow - chart representing the process described.

Rayon is a man - made fibre. It is, infact, a recombinant natural fibre - cellulose. Rayon is made by dissolving cellulose in a solution of sodium hydroxide, or caustic soda, as it is usually called. The cellulose is obtained from shredded wood pulp. The dissolved cellulose is formed into threads by forcing it through a spinneret in a setting bath of dilute sulphuric acid. The threads are drawn from the setting bath wound on a reel, washed, then dried on a heated roller and finally wound on to a bobbin.

3. Read the following passage carefully and draw a flow chart.

Calcareous material like limestone/marl is one raw material. Argillaceous material like clay/ shale is another raw material. Limestone/marl is crushed and powdered and sent to the storage silos. Clay /shale pass through washing and reach the wash basins. The powdered limestone from the storage silo and the clay/shale from the wash basins are proportionately mixed and sent to the unit where they are ground. After grinding, the mixture becomes slurry. The slurry is passed through the correcting basin and the slurry storage tank into the rotary kiln. Coal which is crushed and dried and pulverized in the grinding ball mill reached the rotary kiln where the slurry is heated. From the kiln, the material reaches the cement clinker from where the stage for being cooled. After cooling, it passes into the clinker storage from where it reaches the clinker grinding elevators. Gypsum is added at this stage. From the

grinding elevators, cement reaches then silos. From the silos, it becomes cement ready to be weighed and packed.

INTERPRETING VISUAL MATERIALS

Transform the above information into a flowchart

- Look at the following table, describe and comment on it in not more than 150 words.

Steel production (in million tons)

Sl. No.	Country	1995	1996	1997
1	Japan	105.3	98.3	98.5
2	USA	80.1	74.0	81.0
3	China	46.7	51.9	55.3
4	Germany	40.5	71.1	36.3
5	India	10.5	11.9	12.3
	Total world production	720.1	715.4	734.7

- The table below shows the figures for imprisonment in five countries between 1930 and 1980.

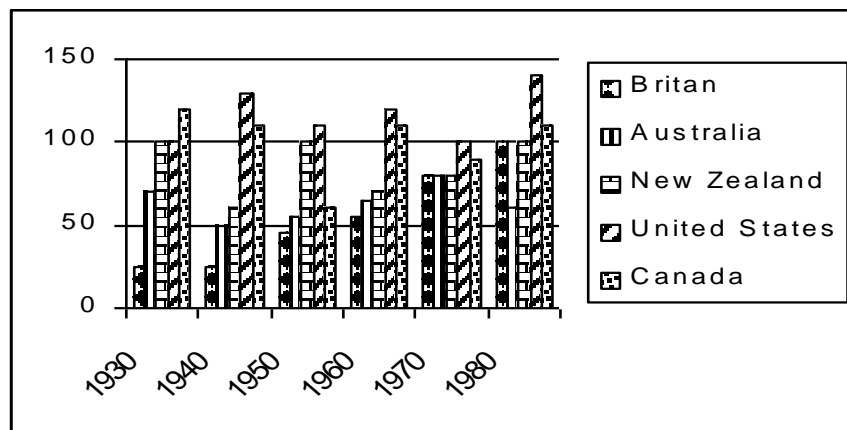

- Convert the following flow chart into a paragraph of about 150 words. Use an introductory and concluding sentences with proper sequential expressions and appropriate connectives.

4. Today, the use of cement has increased enormously. Building activities have gone up many fold, thanks to the liberal sanction of house building loans by various agencies. Naturally, the demand for cement is high and these industries are making good profits. But, not many people know of the manufacture of cement from rice husk; that is equally strong as cement. An equal weight of rice husk and lime sludge (i.e. the waste lime sediment that is available in plenty in sugar and other industries) are mixed thoroughly so that it becomes a paste. This mixture is made into cakes of desired shape and manageable size and these cakes are dried completely in sunlight. Once they are dry, they are burnt in the open and the ash is collected. This ash is ground to a fine powder and what is obtained is rice husk cement.

Transform the above information into a flowchart.

5. Convert the following tree diagram into a paragraph of about 150 words. Use introductory and concluding sentences with proper sequential expressions and appropriate connectives.

Social Media Tree



Convert the following flow chart into a paragraph of about 150 words with proper sequential expressions and appropriate connectives.

Alarm Setting

