



SNS COLLEGE OF ENGINEERING

Kurumbapalayam (Po), Coimbatore – 641 107

An Autonomous Institution

Accredited by NBA – AICTE and Accredited by NAAC – UGC with 'A' Grade

Approved by AICTE, New Delhi & Affiliated to Anna University, Chennai

DEPARTMENT OF ELECTRICAL AND ELECTRONICS ENGINEERING

COURSE NAME : 19EE01 BASIC ELECTRICAL AND ELECTRONICS ENGINEERING

I YEAR /I SEMESTER AI&DS

Unit 2 – Electrical Machines

Single Phase Induction Motor



SINGLE PHASE MOTOR

- Why do we need motors?
- What action motor do?
- How can I create the motor?
- Why motor rotates in circular motion?



1



PARTS OF MOTOR





CONSTRUCTION OF 1 PH IM

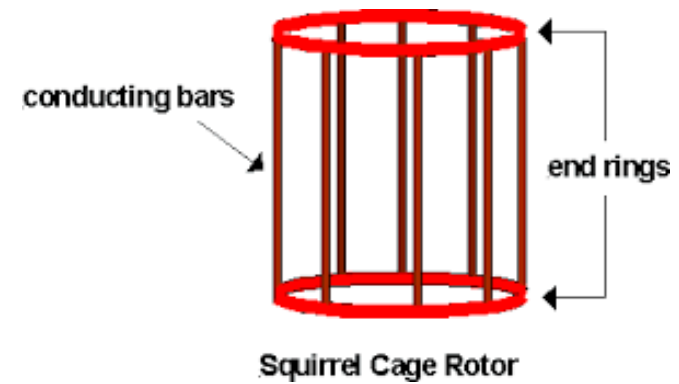
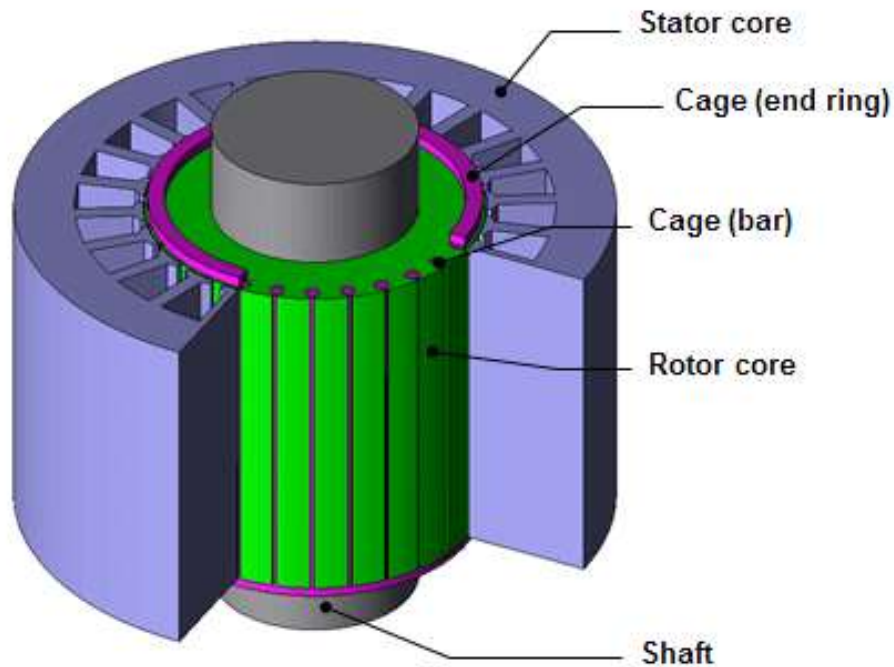



WORKING PRINCIPLE

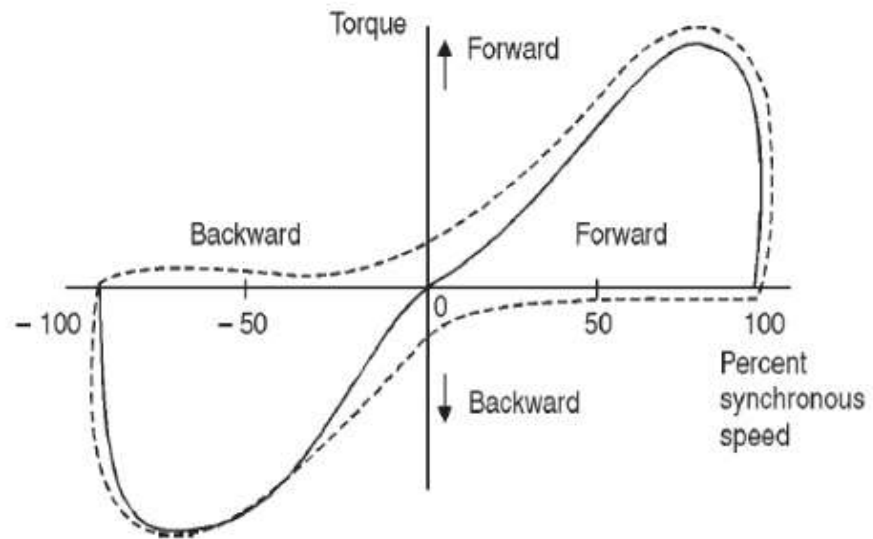
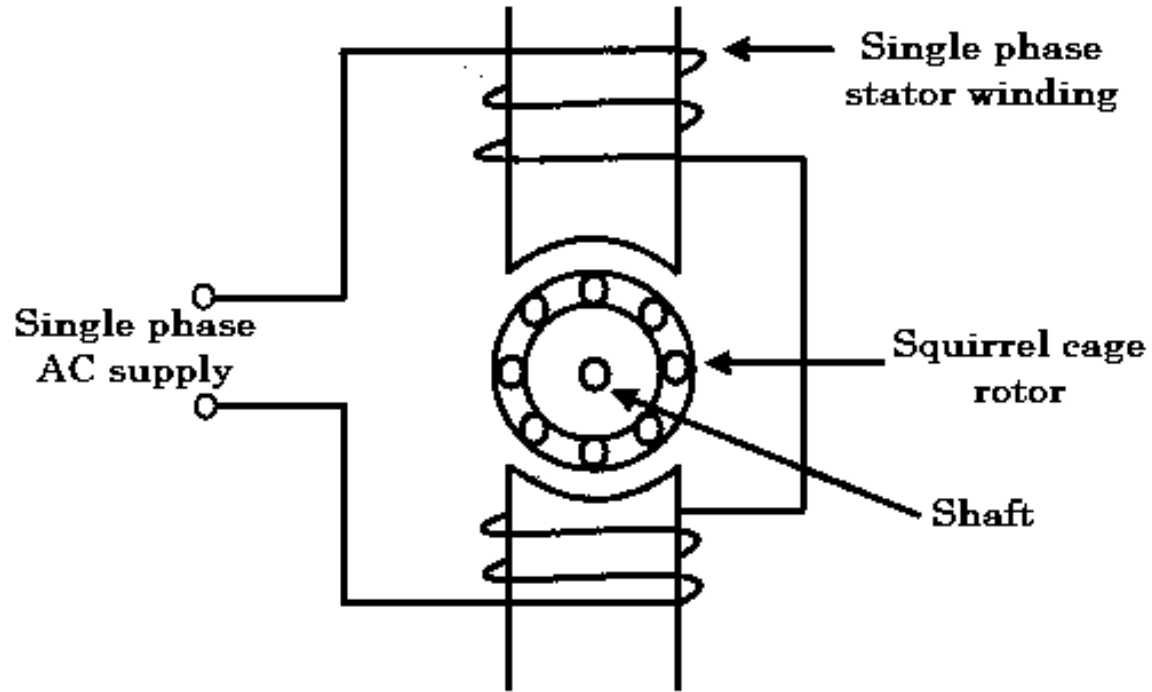



ASSESSMENT 1

1. The torque developed by a single-phase motor at starting is
 - A. less than the rated torque
 - B. More than the rated torque
 - C. zero
 - D. None of the above





SPLIT PHASE IM

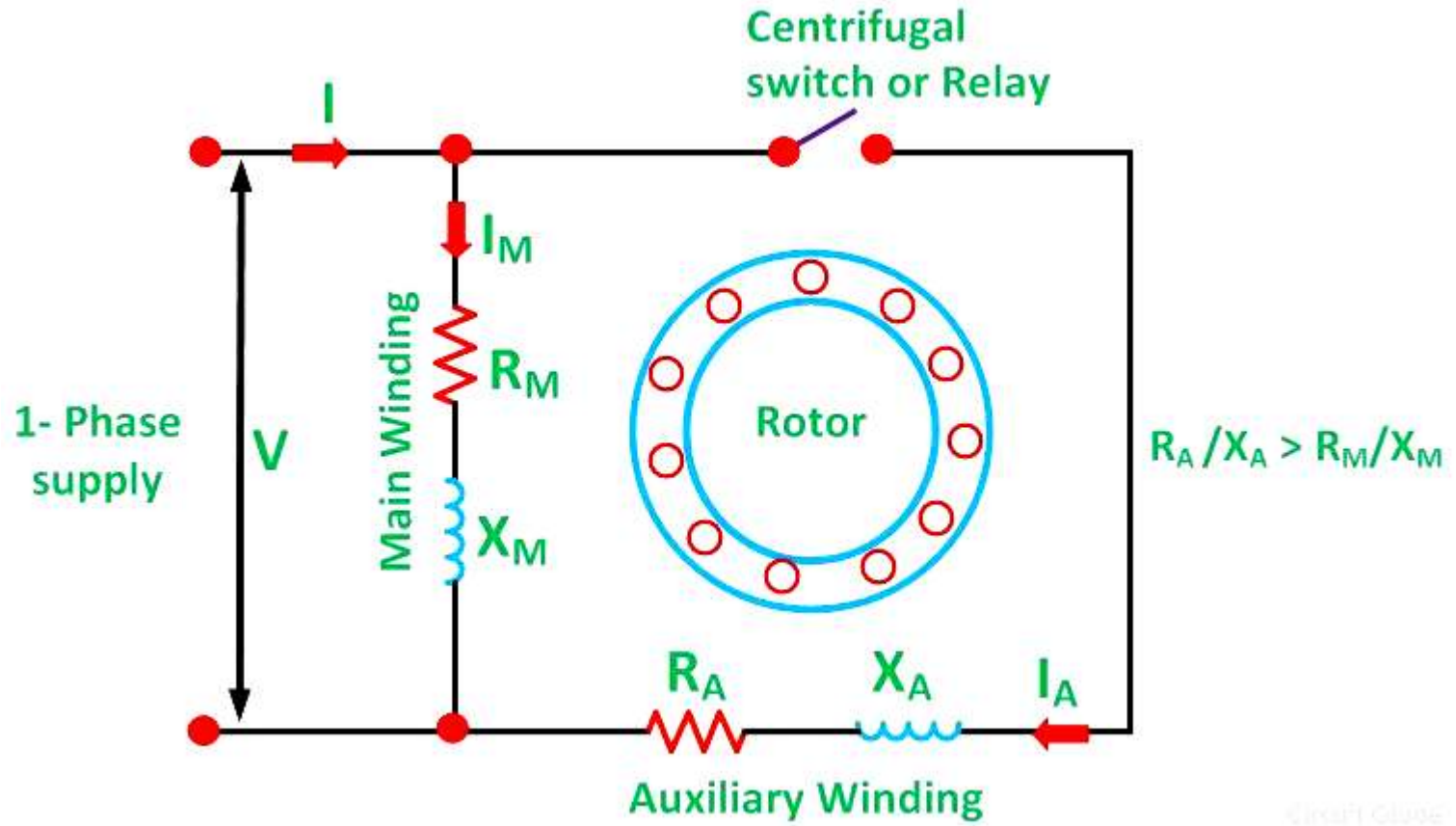

©Sri Sri Gyan





CAPACITOR START IM

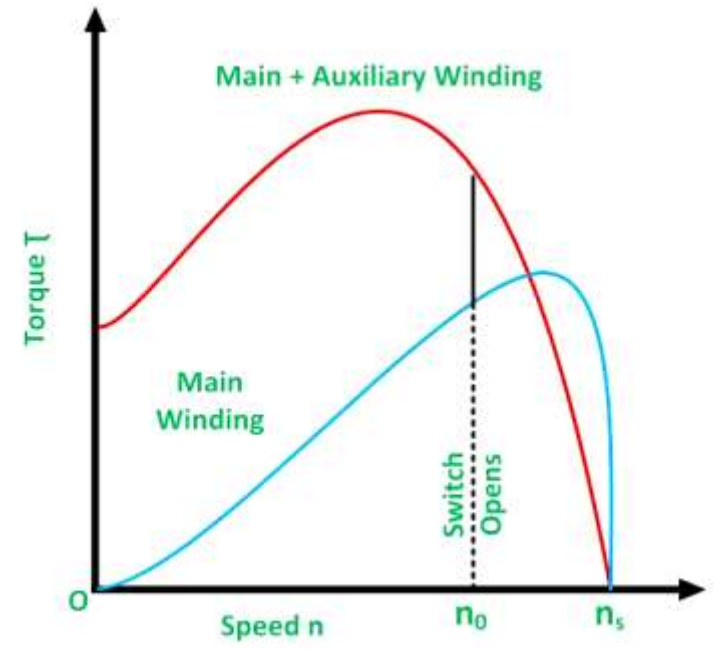
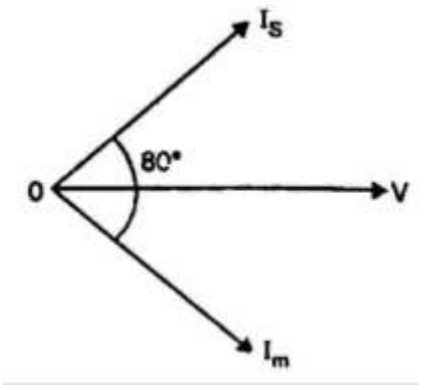
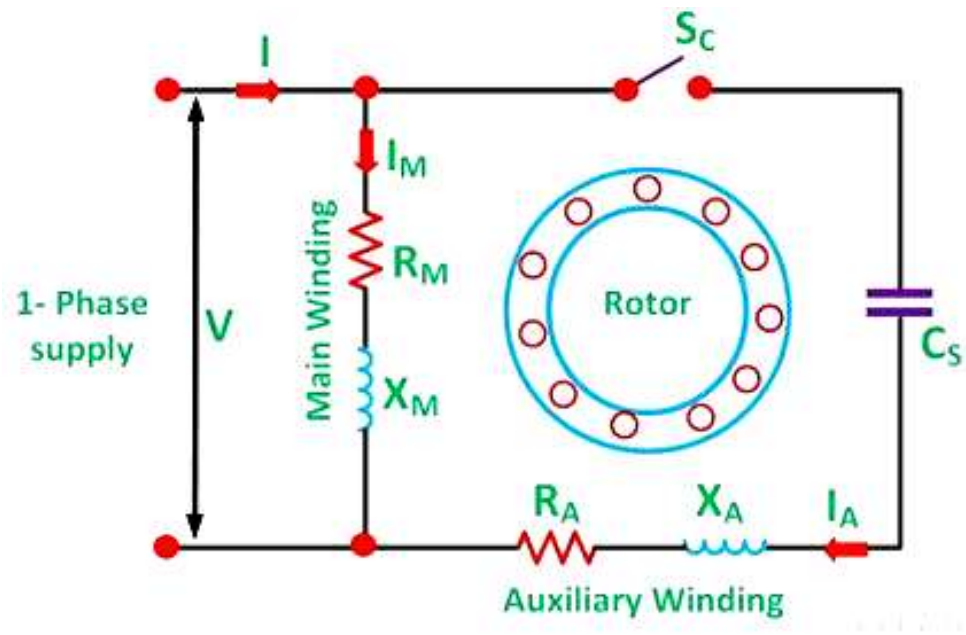
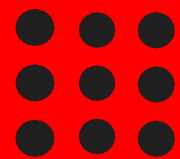



CAPACITOR RUN IM

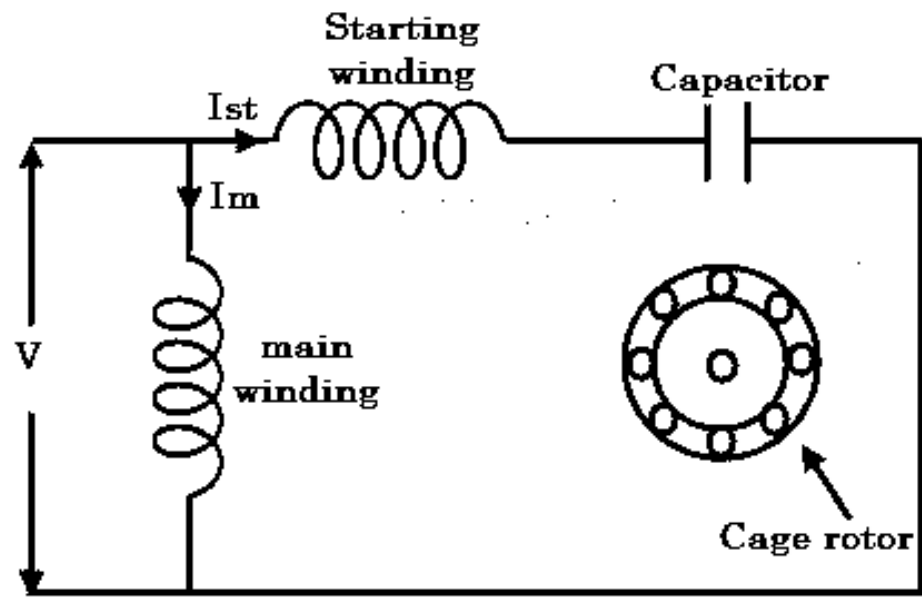
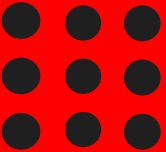

Circuit diagram of capacitor run motor

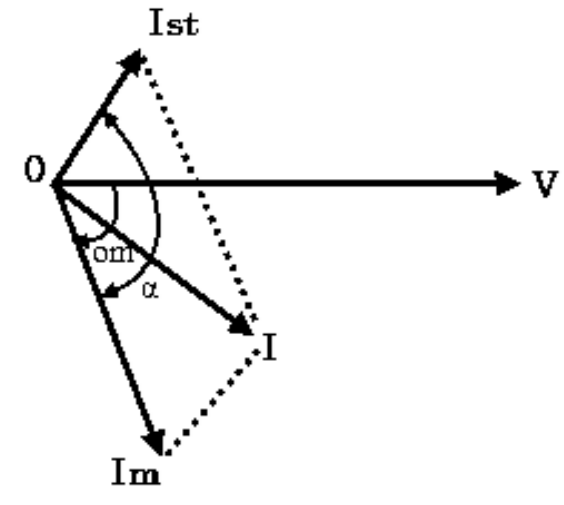

Phasor diagram





CAPACITOR START & CAPACITOR RUN IM

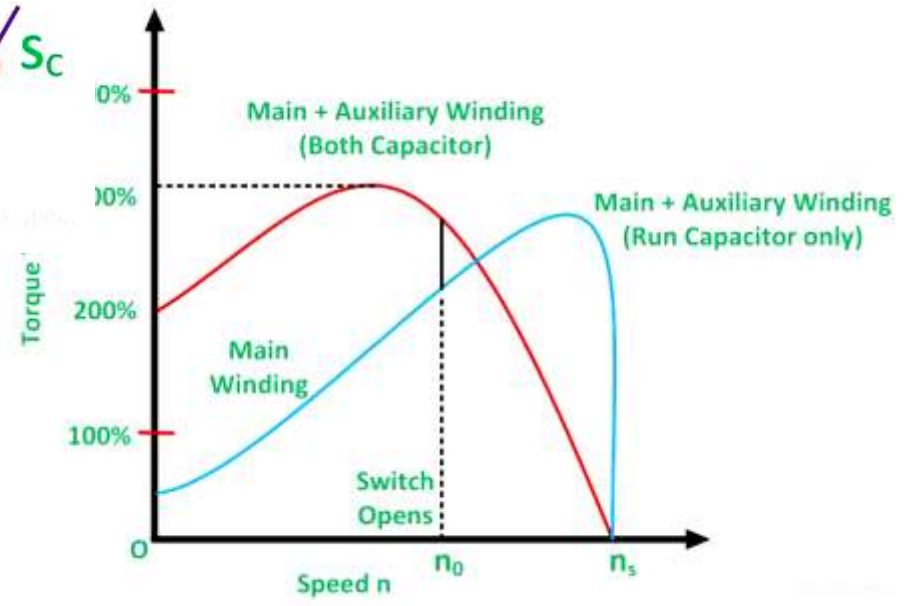
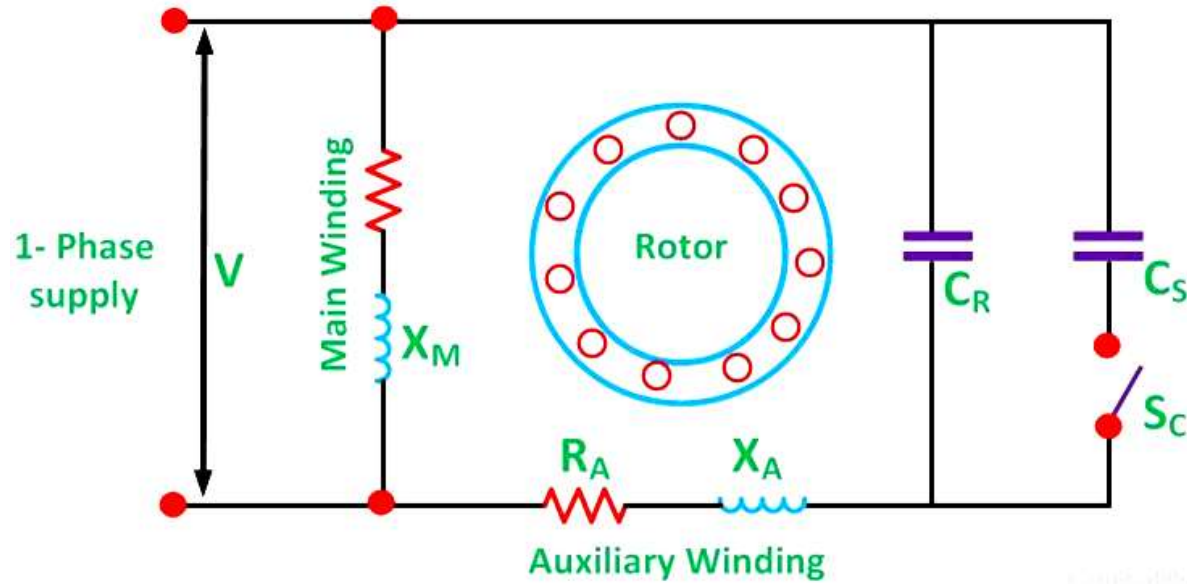



SHADED POLE IM

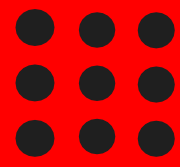
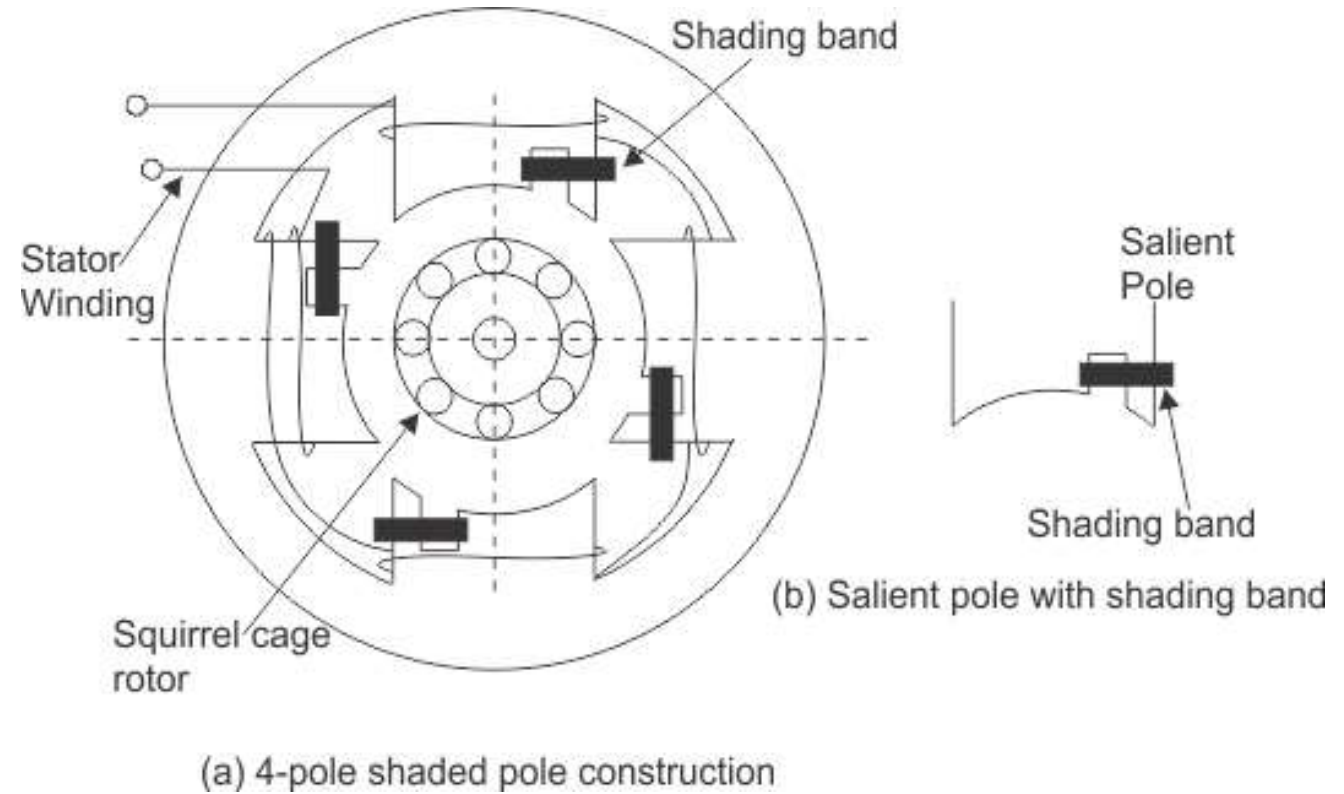



Assessment 2

1. A centrifugal switch is used to disconnect 'starting winding when motor has
- a) Picked up 10% speed
 - b) Picked up 20% speed
 - c) Picked up 5 – 10% speed
 - d) Picked up 50 – 70% speed





REFERENCES

1. Bhattacharya. S.K, “Basic Electrical and Electronics Engineering”, Pearson Education , (2017)
2. Muthu Subramanian R, Salivahanan S,“ Basic Electrical and Electronics Engineering”, Tata McGraw Hill Publishers, (2009)
3. V.Mittle“ Basic Electrical Engineering”, Tata McGraw Hill Publishers, (2017)
4. Nagrath. I.J, “Electronics: Analog and Digital”, Prentice Hall India Pvt. Ltd., (2013)

THANK YOU