

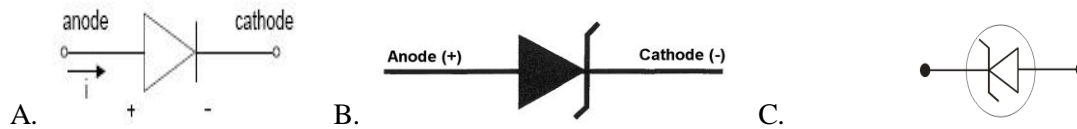

UNIT IV: Digital Electronics

1. Choose the Symbol of PN junction diode:-



2. PN junction diode acts as -----?

CLUE: Rectifiers

3. When the negative terminal is connected to positive terminal and when the positive terminal is connected to negative terminal then it is called as----- bias



CLUE :

4. Diode acts As a -----



CLUE :

3. Conversion happen by diode: This is called as _____

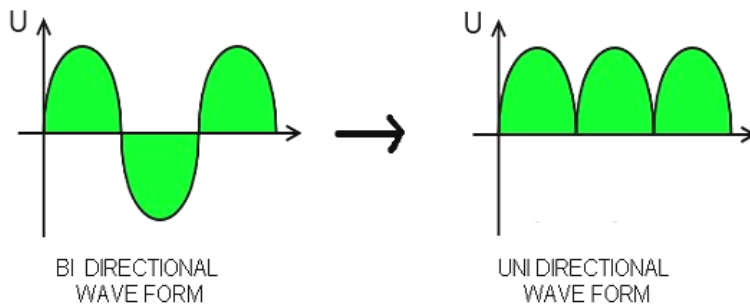

4 Type of the Diode

TCHOYTKS DIEDO

NEUTLN DEIDO

TAVRAORC DEDIO

ZEERN DEDIO

5. The ratio of rms value of Ac component to Dc component in the output is called as

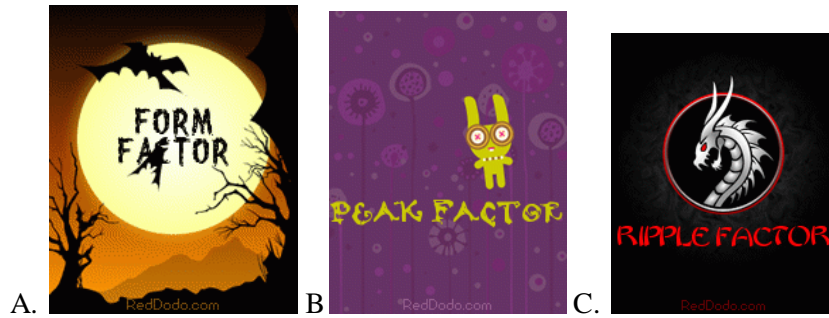

6. The need for a center tapped transformer in Full wave rectifier is eliminated in -----

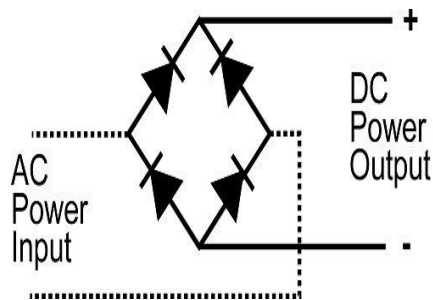

CLUE:

7 Peak factor of half wave rectifier is

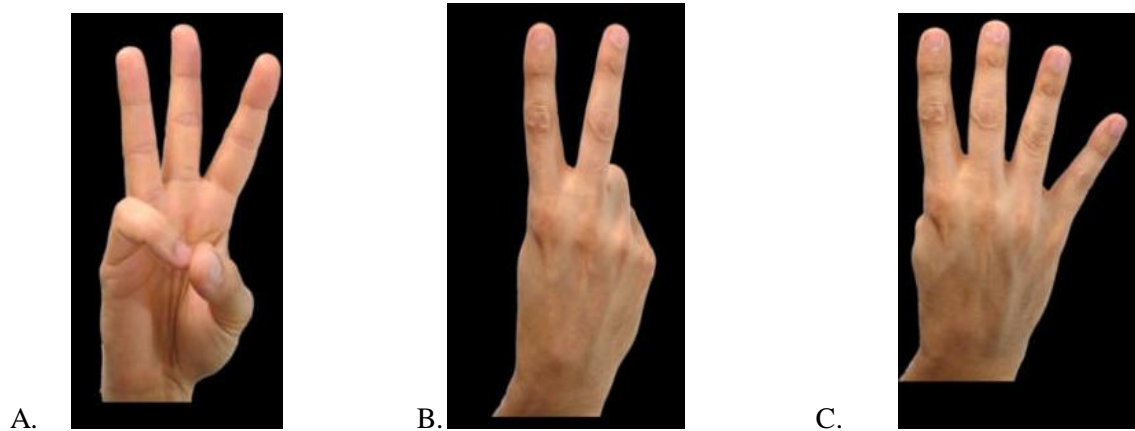

8. Find the odd man out

a. Inductor filter b. capacitor filter c. Rc filter

9. which works under the phenomena of electroluminescence

CLUE:



10. Identify the characteristics of the figure:

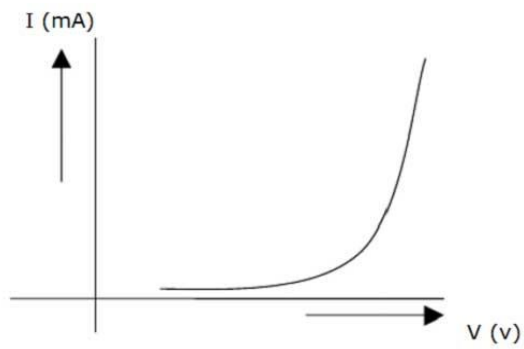

11. Threshold voltage for germanium

A.  RedDodo.com

B.  RedDodo.com

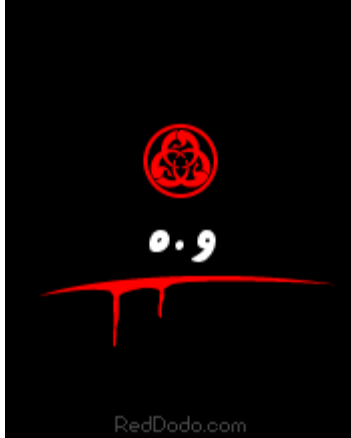
C.  RedDodo.com

12. Work function is the maximum energy required by the fastest electron at 0 K to escape from the metal surface.

A. True

B. False

13.Reverse saturation current -----for every 10 degree increase in temperature????

Clue:



14. ZENER DIODE AS A REGULATOR

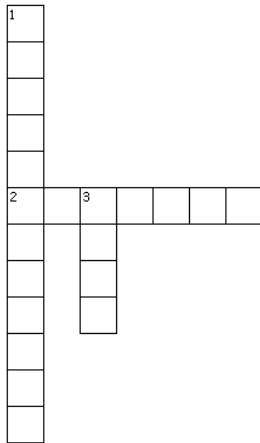

ACROSS:

2. Two types of regulation are------(2)regulation and load regulation

DOWN:

1. Maximum current will flow through the zener diode during -----(1)

3.The purpose of ais to maintain a constant voltage across a load regardless of variations in the applied input voltage and variations in the load current.(3)

15.Among the configuration which one is the best

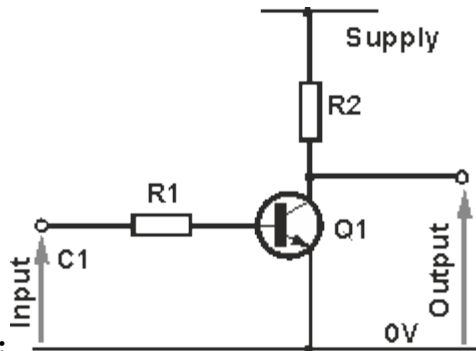

CLUE:

16. Transistor has ----- types of configuration

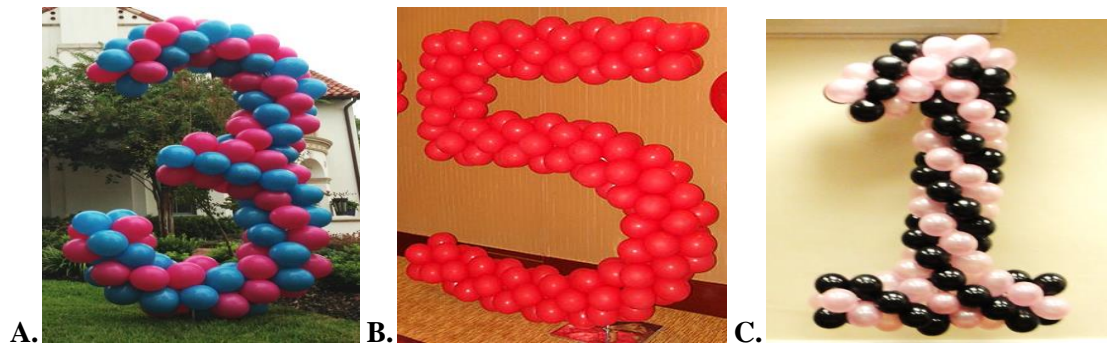

17. Transistor acts as a -----

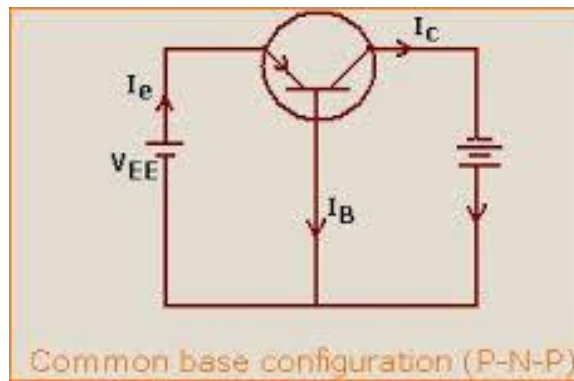

18. Common base has a current gain of

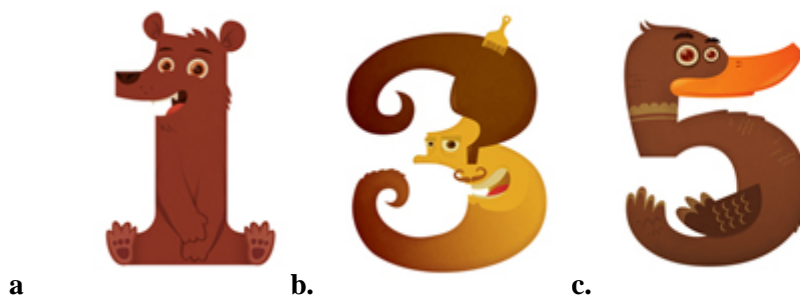

19. Find the odd man out

- a. CE configuration
- b. CC configuration
- c. ZC configuration

50. Common emitter is ----- doped

CLUE:



20. When a snowball rolls down a snowy hill, it picks up snow, which causes it to roll faster. The result is that the snowball will pick up more snow and roll even faster. This scenario would best be described as:

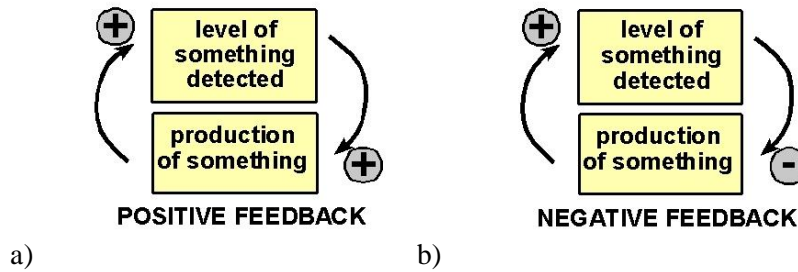

21. The audio amplifier response curve illustrated in Fig. 3 shows which of the following problems?

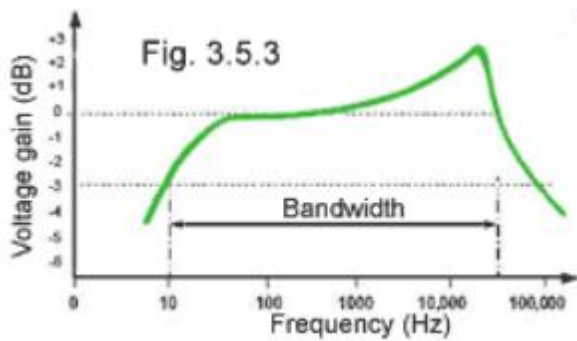

- a) Frequency distortion
- b) Amplitude distortion

22. The most commonly used semiconductor material is

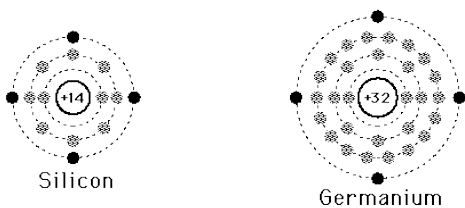

23. In which of these is reverse recovery time nearly zero?

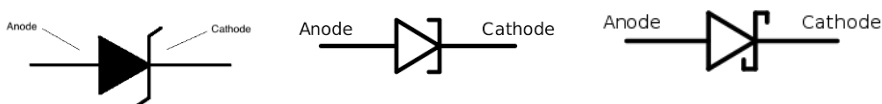

24. The unit of trans conductance is

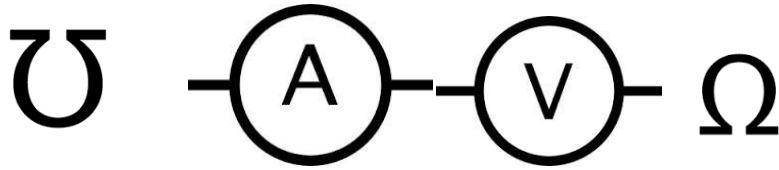

25. The voltage at which avalanche occurs is



Clue:

26. In a bipolar transistor the base collector junction has-----bias

Clue:



a)



b)

27. Free electrons exist in-----band

Clue:

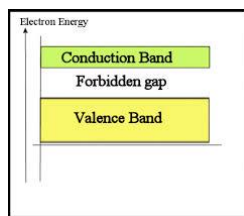

28. The figure represents a -----



31) The BJT is a _____ controlled device

32) When transistors are used in digital circuits they usually operate in the saturation and _____ region

Clue:

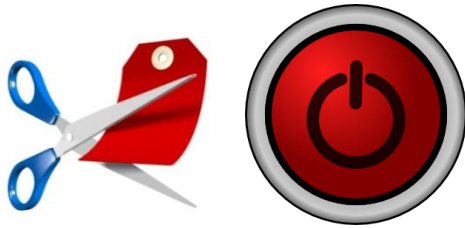

33) Electromechanical device that use electromagnetism to produce a mechanical operation.

Clue:

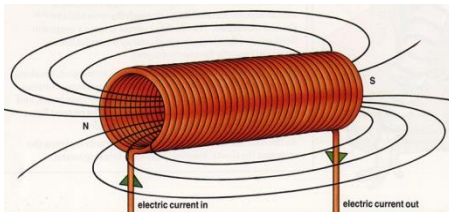

34) What is the resistor value in the given circuit?

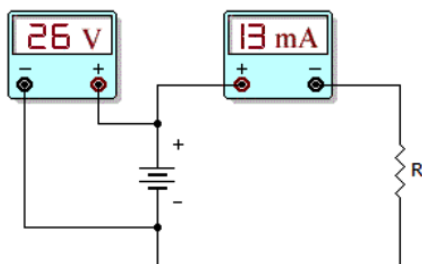

- a) 1 k ohm
- b) 2 k ohm
- c) 3 k ohm
- d) 4 k ohm