



# SNS COLLEGE OF ENGINEERING

Kurumbapalayam (Po), Coimbatore - 641 107

**An Autonomous Institution**

Accredited by NBA – AICTE and Accredited by NAAC – UGC with 'A' Grade

Approved by AICTE, New Delhi & Affiliated to Anna University, Chennai

## DEPARTMENT OF ELECTRICAL AND ELECTRONICS ENGINEERING

COURSE NAME : 19EE01 BASIC ELECTRICAL AND ELECTRONICS ENGINEERING

I YEAR /I SEMESTER MECHANICAL ENGINEERING

Unit 2 – Electrical Machines

Single Phase Induction Motor

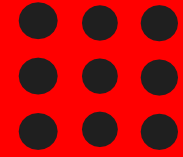



# SINGLE PHASE MOTOR

- Why do we need motors?
- What action motor do?
- How can I create the motor?
- Why motor rotates in circular motion?



1



# PARTS OF MOTOR



SINGLE PHASE IM/19EE101- BEEE/EEE/SNSCE



# CONSTRUCTION OF 1 PH IM

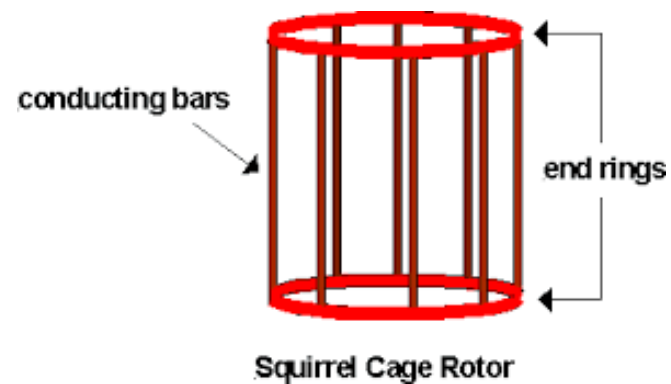
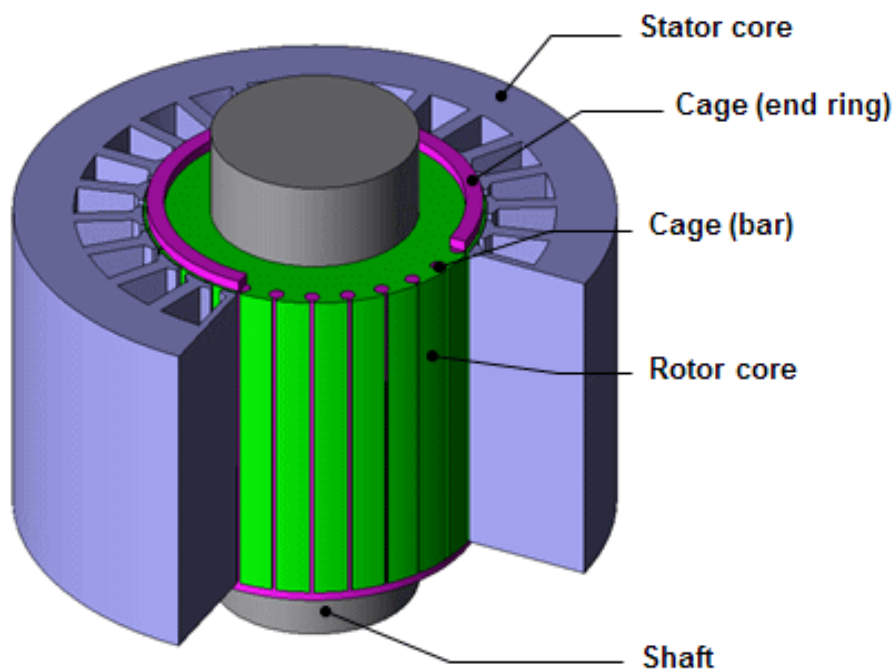



# WORKING PRINCIPLE

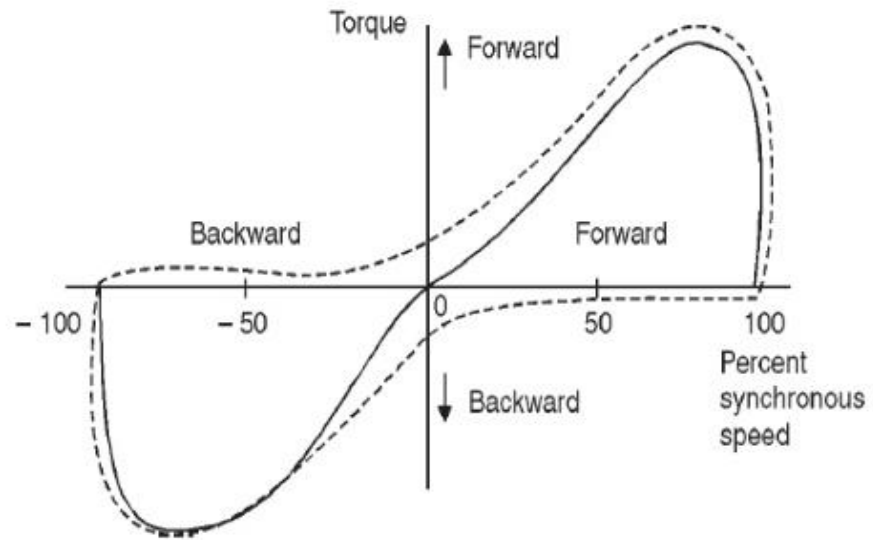
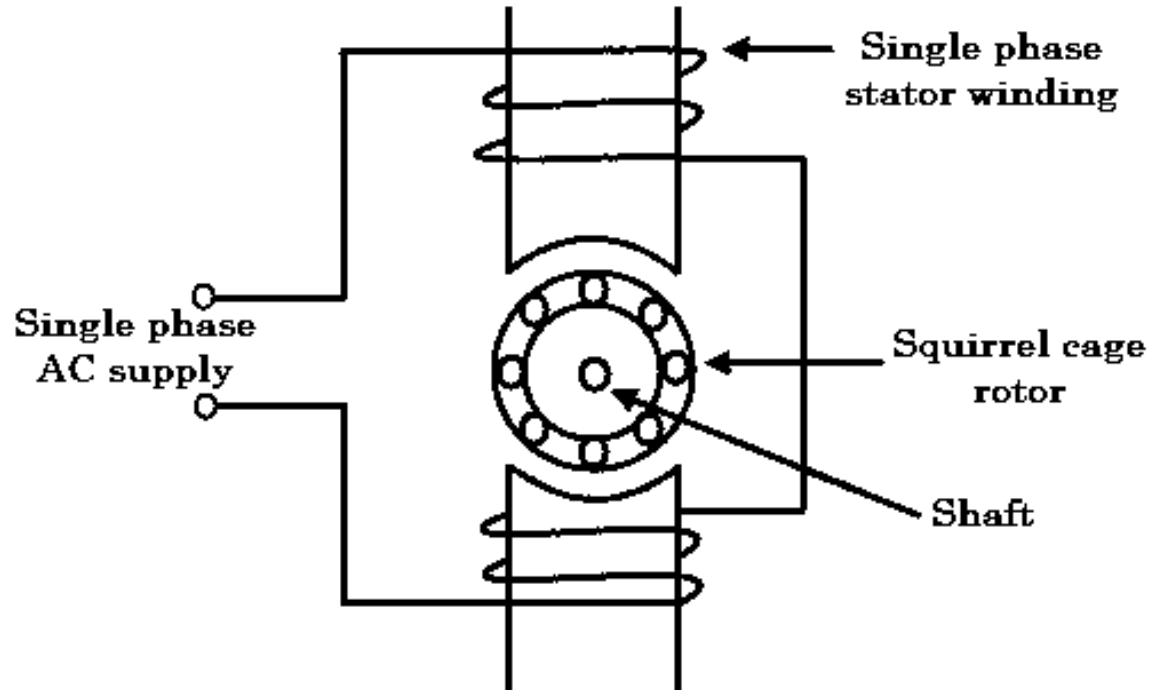



# ASSESSMENT 1

1. The torque developed by a single-phase motor at starting is
  - A.less than the rated torque
  - B.More than the rated torque
  - C.zero
  - D.None of the above





# SPLIT PHASE IM

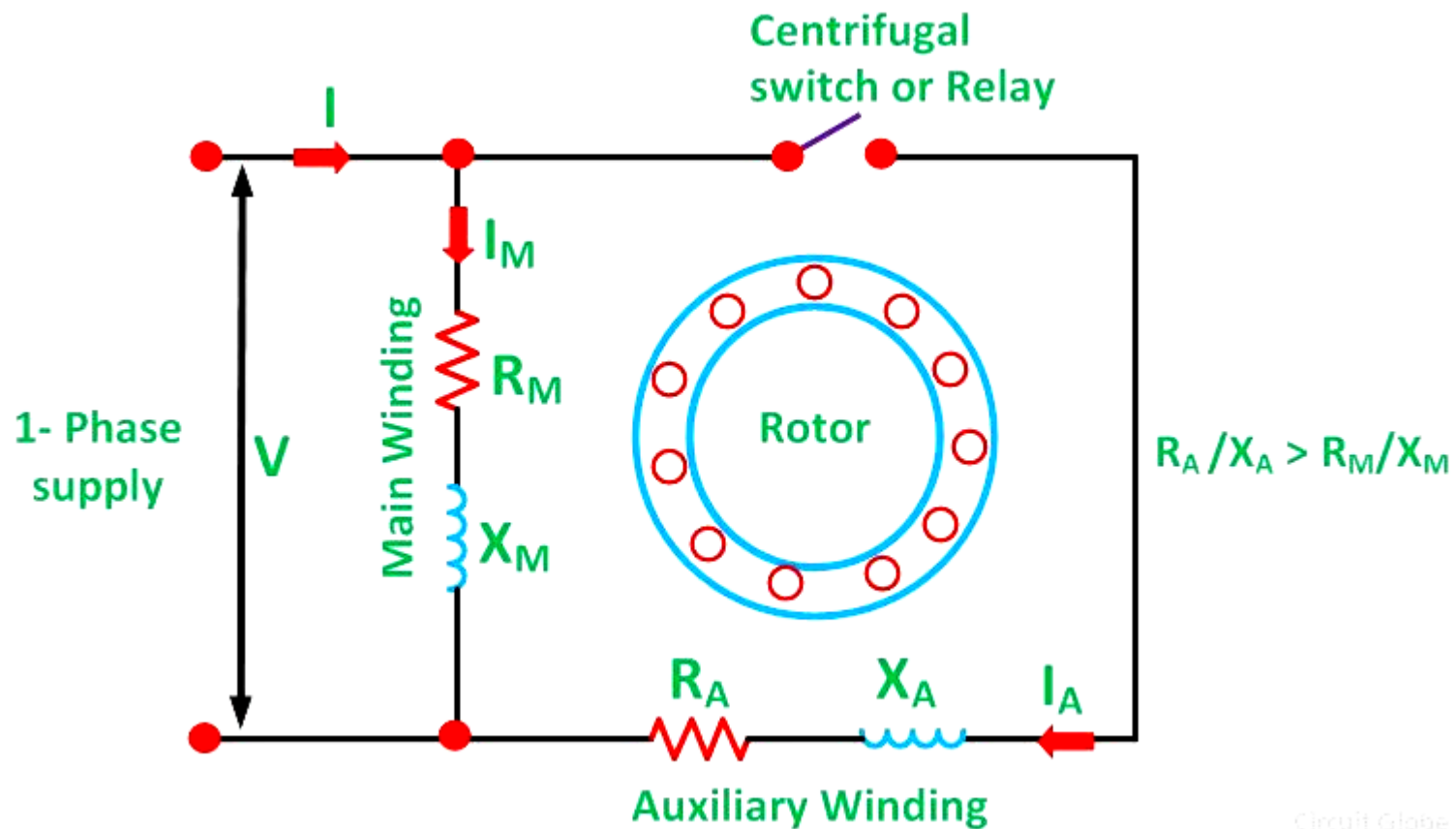



# CAPACITOR START IM

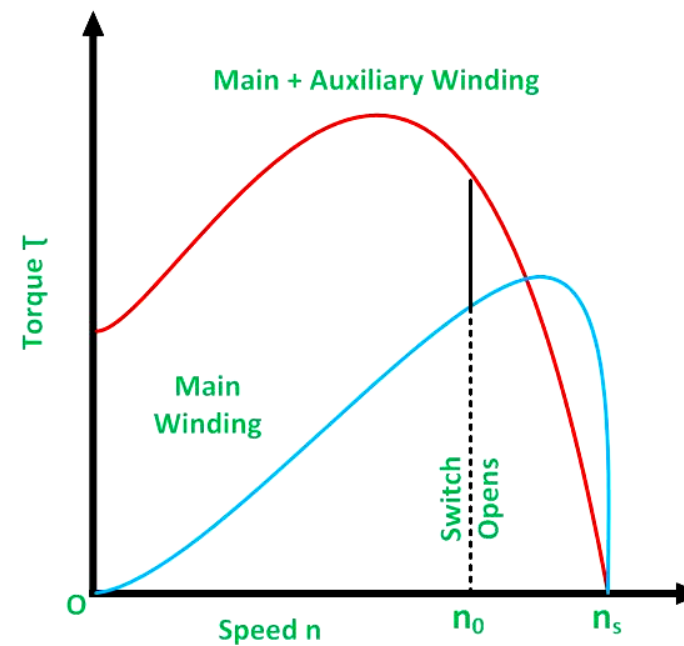
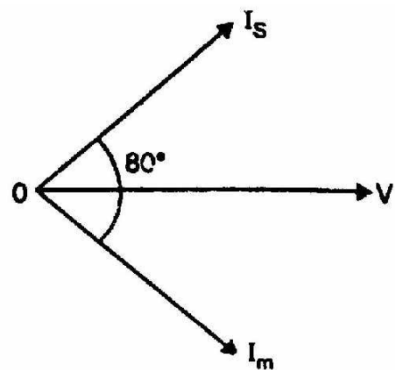
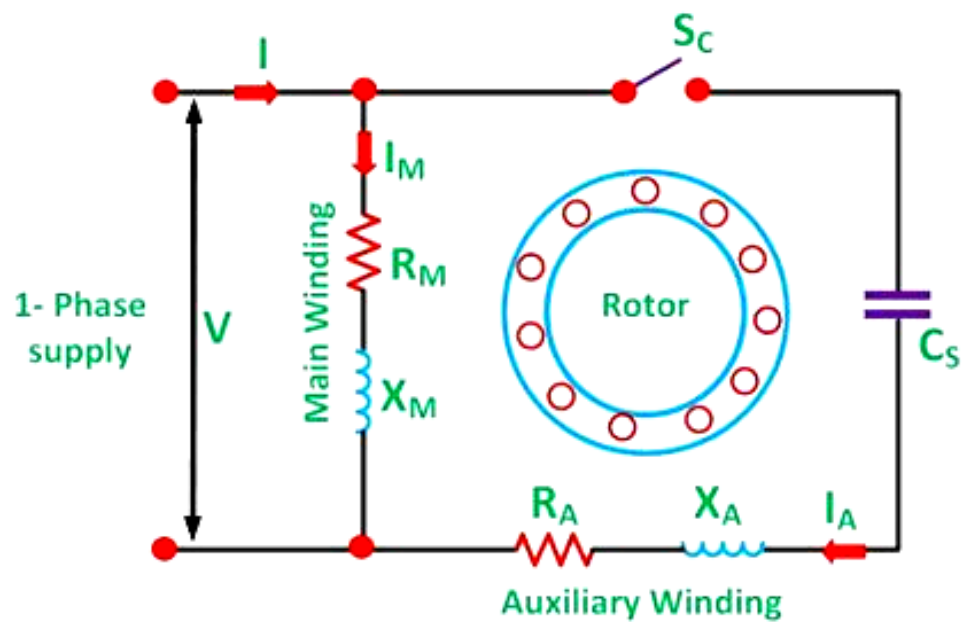

Circuit Globe





# CAPACITOR RUN IM

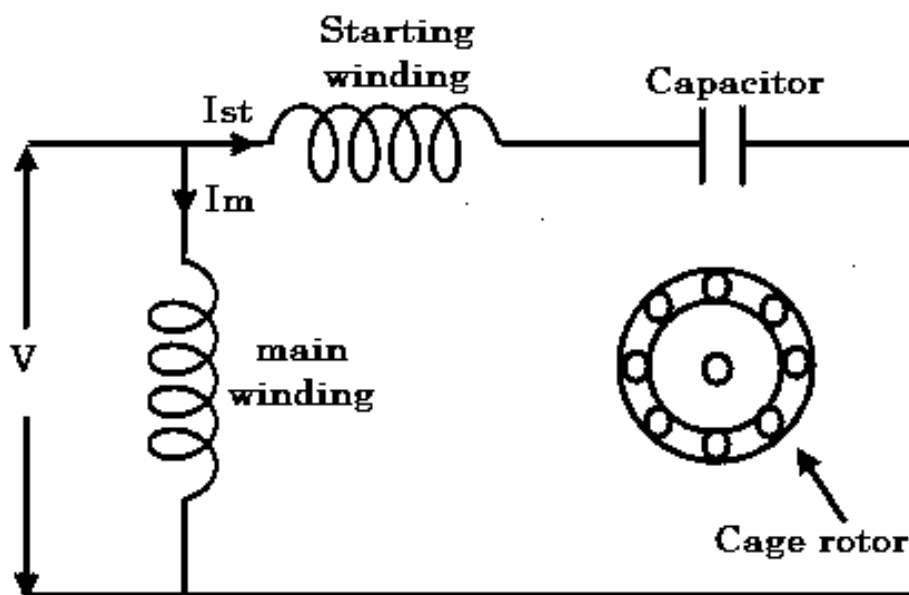

Circuit diagram of capacitor run motor

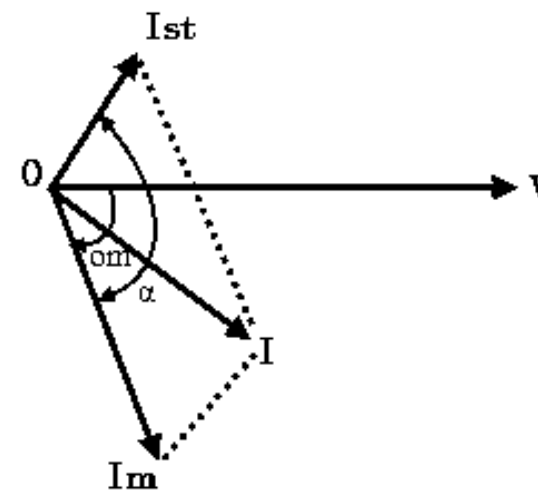

Phasor diagram



# CAPACITOR START & CAPACITOR RUN IM

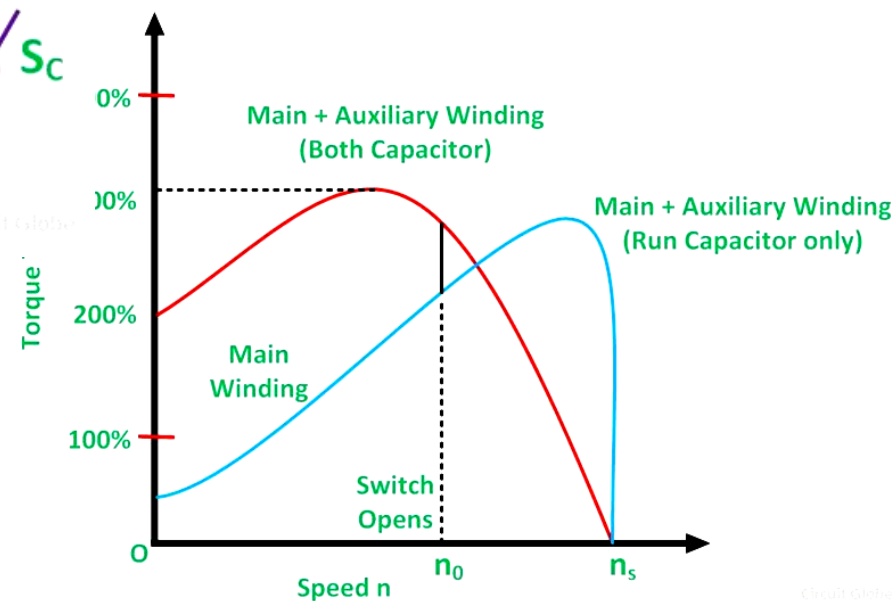
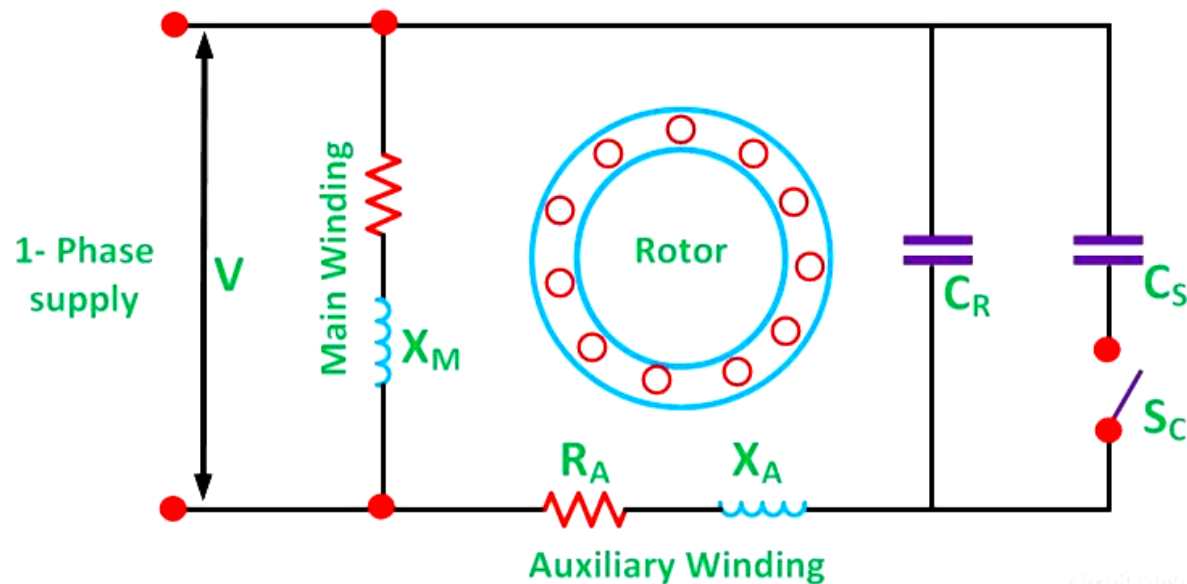



# SHADED POLE IM

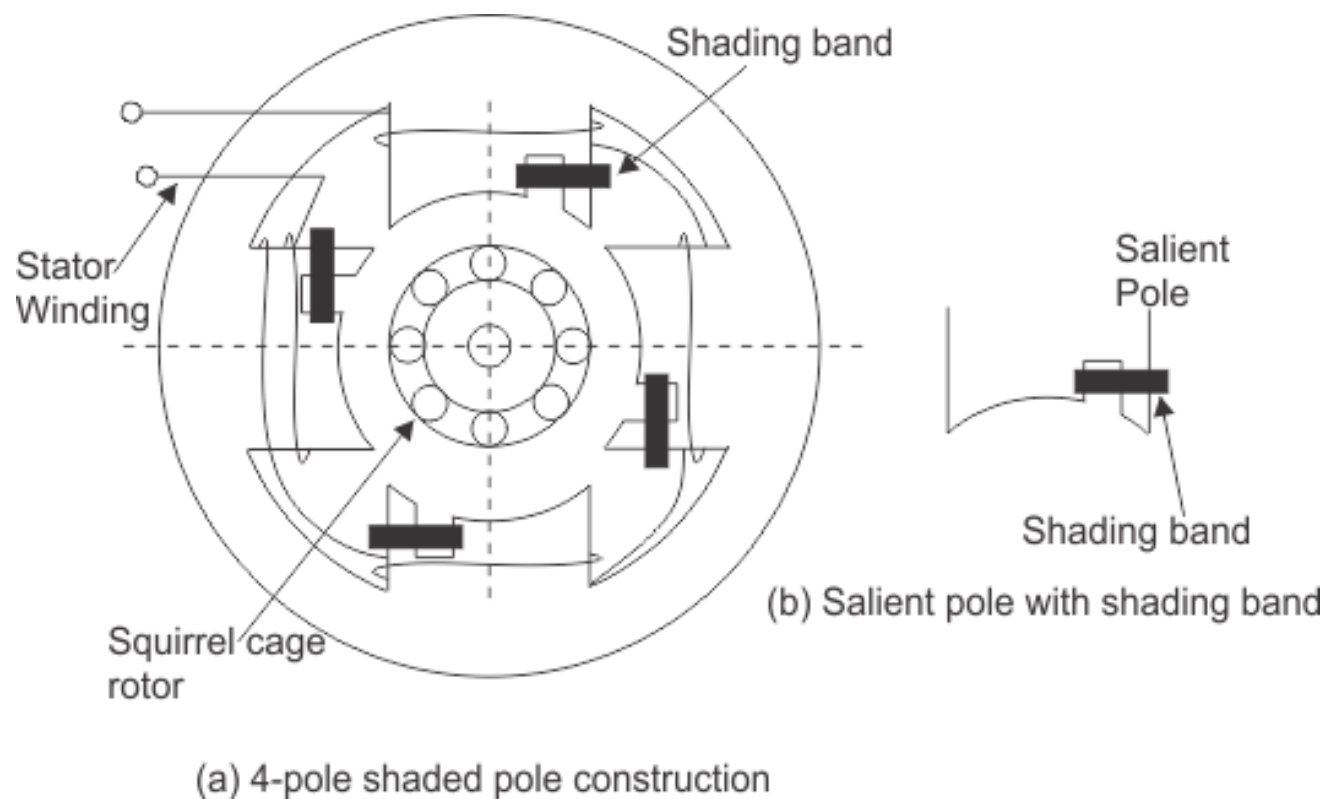



# Assessment 2

1. A centrifugal switch is used to disconnect 'starting winding when motor has
- a) Picked up 10% speed
  - b) Picked up 20% speed
  - c) Picked up 5 – 10% speed
  - d) Picked up 50 – 70% speed





# REFERENCES

1. Bhattacharya. S.K, “Basic Electrical and Electronics Engineering”, Pearson Education , (2017)
2. Muthu Subramanian R, Salivahanan S,“ Basic Electrical and Electronics Engineering”, Tata McGraw Hill Publishers, (2009)
3. V.Mittle“ Basic Electrical Engineering”, Tata McGraw Hill Publishers, (2017)
4. Nagrath. I.J, “Electronics: Analog and Digital”, Prentice Hall India Pvt. Ltd., (2013)

## THANK YOU