



SNS COLLEGE OF ENGINEERING

Kurumbapalayam (Po), Coimbatore – 641 107

An Autonomous Institution

Accredited by NBA – AICTE and Accredited by NAAC – UGC with 'A' Grade

Approved by AICTE, New Delhi & Affiliated to Anna University, Chennai

DEPARTMENT OF ELECTRICAL AND ELECTRONICS ENGINEERING

COURSE NAME : 19EE01 BASIC ELECTRICAL AND ELECTRONICS ENGINEERING

I YEAR /I SEMESTER MECHANICAL & MECHATRONICS ENGINEERING

Unit 2 – Electrical Machines

DC Motor Construction and Working principle



DC MOTORS

- Why do we need motors?
- What action motor do?
- How can I create the motor?
- Why motor rotates in circular motion?

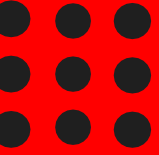



DC MOTOR CONSTRUCTION

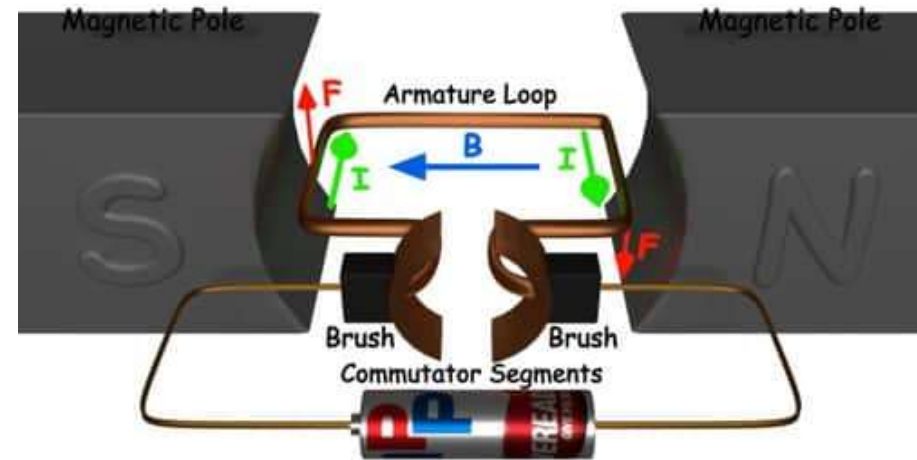
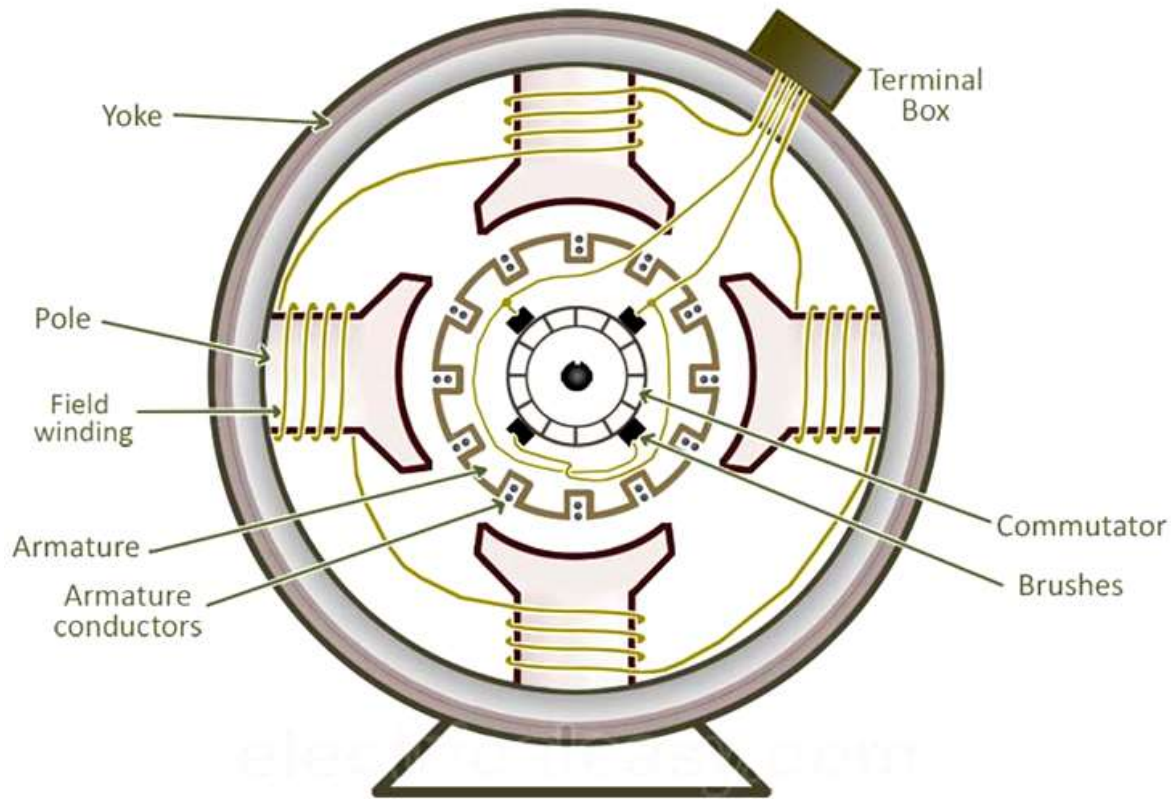
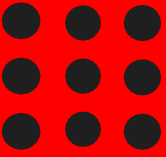



WORKING PRINCIPLE

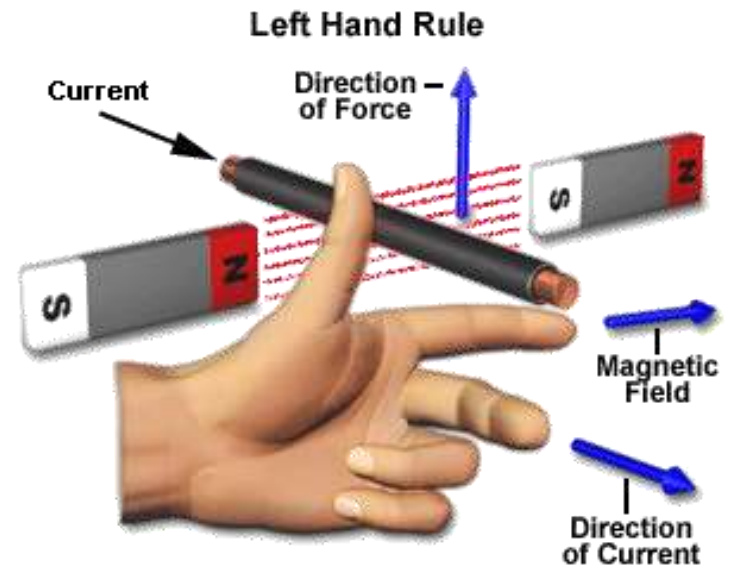
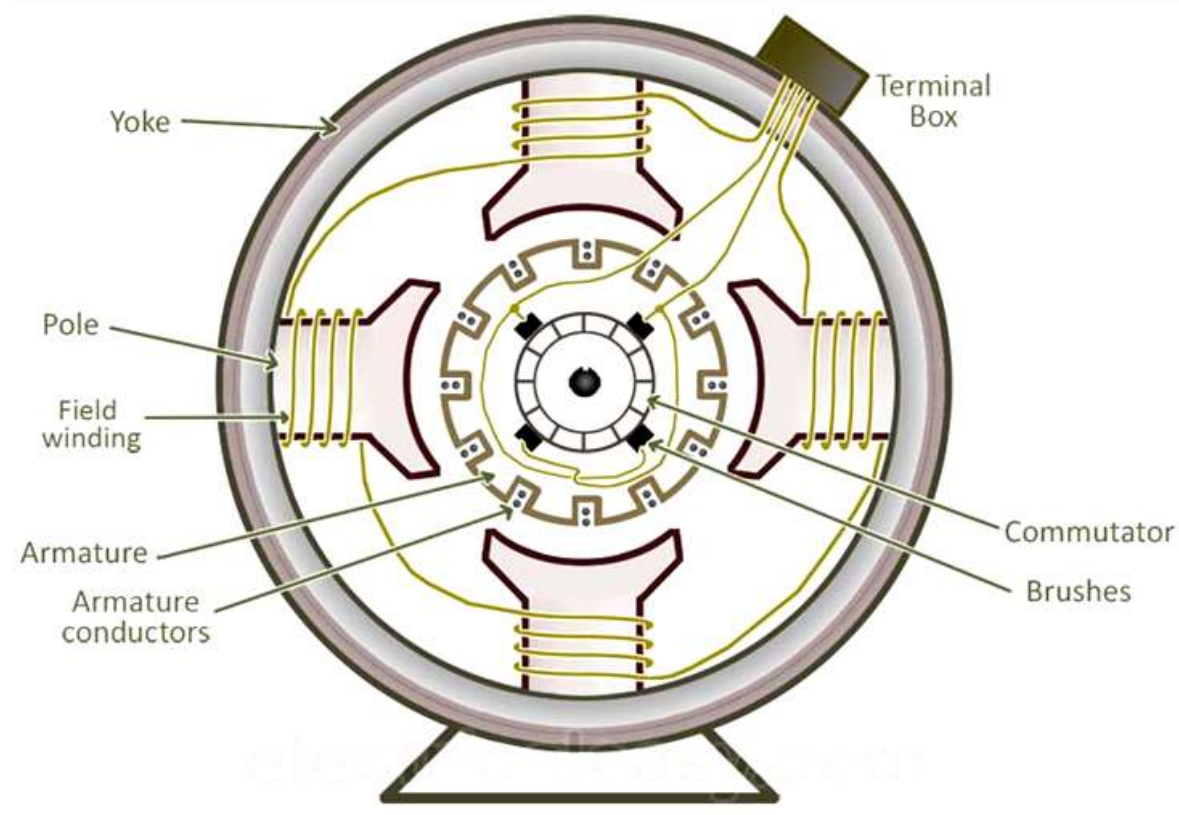
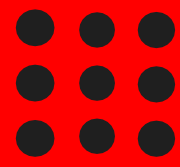



MOTORING ACTION

- If a current carrying conductor is placed in a magnetic field perpendicularly, then the conductor experiences a force in the direction mutually perpendicular to both the direction of field and the current carrying conductor.

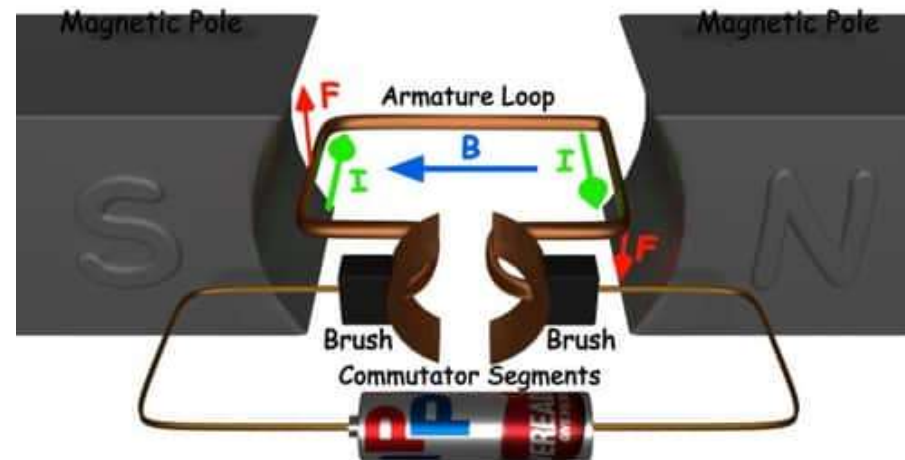



ASSESSMENT 1

1.State the principle of DC Motor





TORQUE PRODUCTION

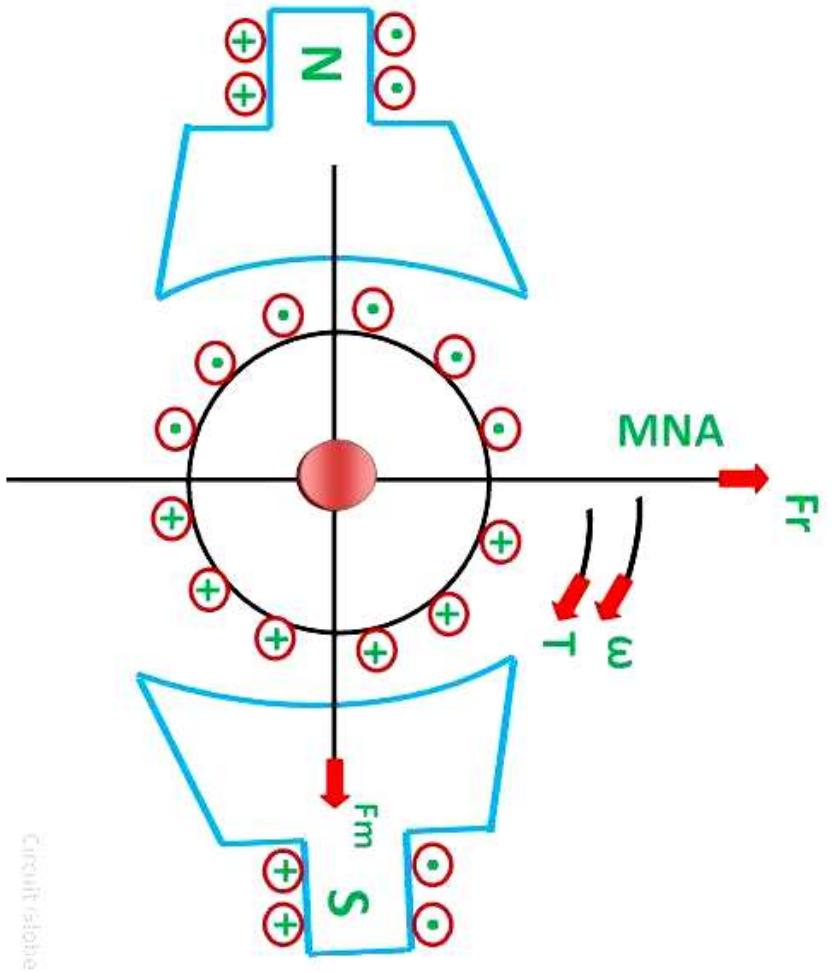
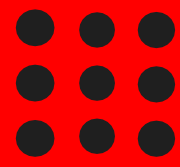

Two Forces

Supporting & Cancelling





SHUNT MOTOR

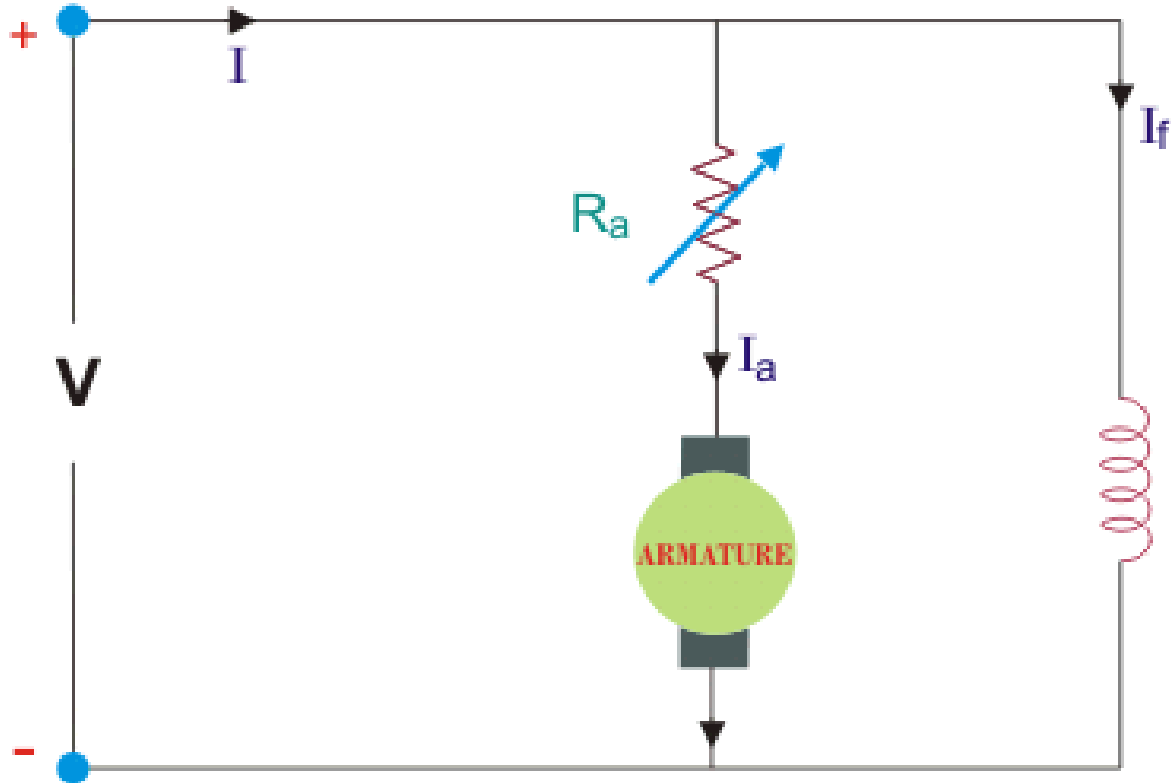
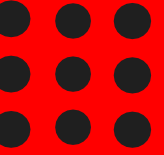

Derive the voltage equation for DC Shunt Motor





SERIES MOTOR

Derive the voltage equation for DC Series Motor

➤ Series DC motor

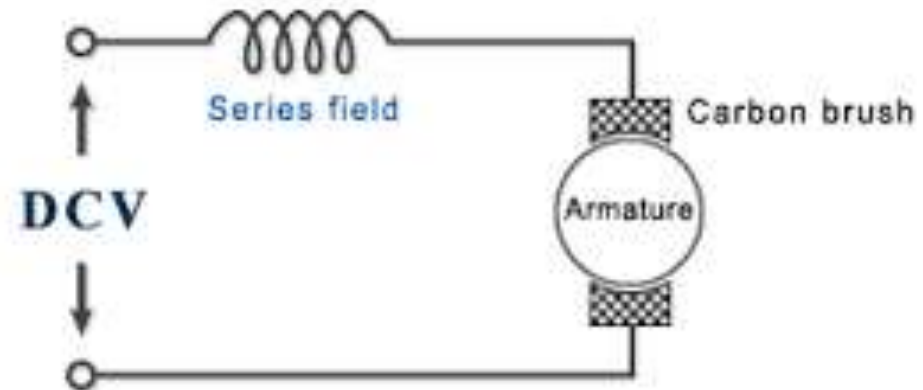



COMPOUND MOTOR

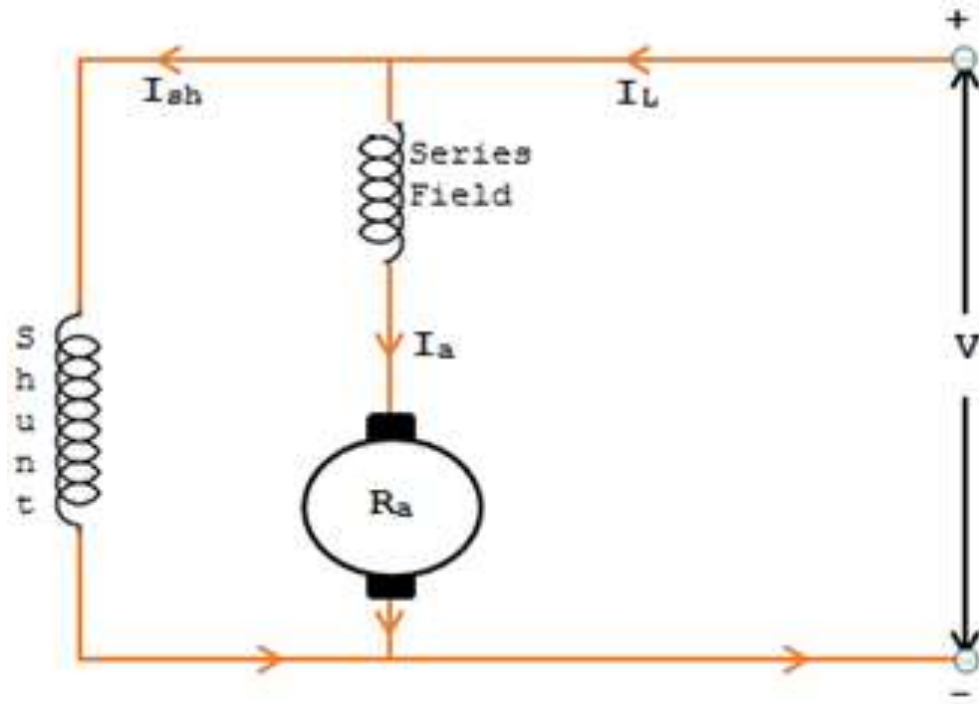

Derive the voltage equation for DC Compound Motor



Assessment 2

1. Compare DC Shunt Motor and DC Series Motor.





REFERENCES

1. Bhattacharya. S.K, “Basic Electrical and Electronics Engineering”, Pearson Education , (2017)
2. Muthu Subramanian R, Salivahanan S,“ Basic Electrical and Electronics Engineering”, Tata McGraw Hill Publishers, (2009)
3. V.Mittle“ Basic Electrical Engineering”, Tata McGraw Hill Publishers, (2017)
4. Nagrath. I.J, “Electronics: Analog and Digital”, Prentice Hall India Pvt. Ltd., (2013)

THANK YOU