



SNS COLLEGE OF ENGINEERING

Kurumbapalayam(Po), Coimbatore – 641 107

An Autonomous Institution

Accredited by NAAC-UGC with 'A' Grade

Approved by AICTE, Recognized by UGC & Affiliated to Anna University, Chennai

19EC701 - ADHOC NETWORKS

Unit -2 – DATALINK LAYER – CONTENTION BASED PROTOCOLS WITH SCHEDULING

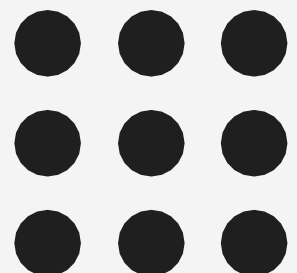



Contention-based Protocols with Scheduling Mechanisms

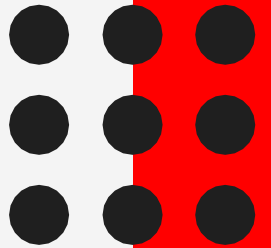

DPS: Distributed Priority Scheduling and MAC in Ad Hoc Networks :

- Provide differentiated QoS levels to different wireless applications in ad hoc networks
- Achievable by QoS-sensitive MAC and network layer scheduling
- Distributed scheduling problem with local information
- Basic mechanisms:
 - Piggyback information
 - Head-of-line (HoL) packet as the packet with the highest priority (lowest index)
 - RTS, CTS : carry current packet info
 - DATA, ACK: carry next head-of-line info

Contention-based Protocols with Scheduling Mechanisms

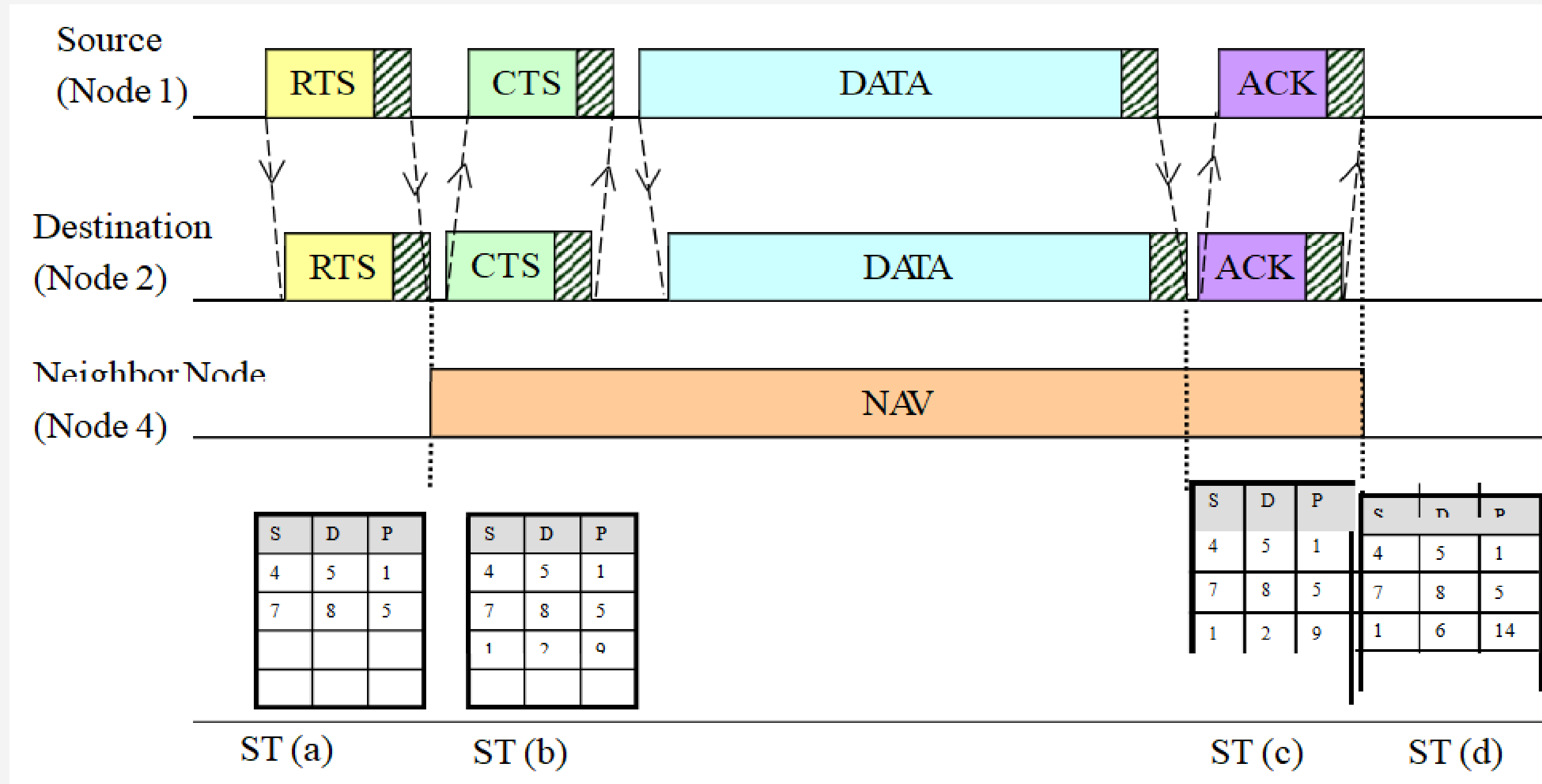
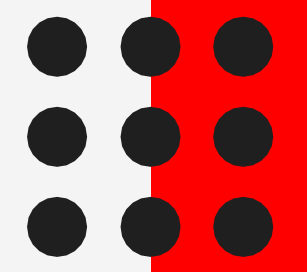



Contention-based Protocols with Scheduling Mechanisms

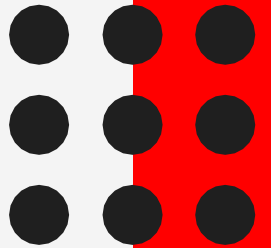

Distributed Wireless Ordering Protocol (DWOP):

- DWOP based on the DSP, ensure that packet access the medium according to the order specified by an ideal reference schedule such as FIFO
- Each node builds up a scheduling table (ST) ordered according to the overheard arrival times
- A node is made eligible to contend for the channel only if its locally queued packet has a smaller arrival time compared to all other arrival times in its ST
- Scheduling problems: Information asymmetry and Perceived collisions



Contention-based Protocols with Scheduling Mechanisms

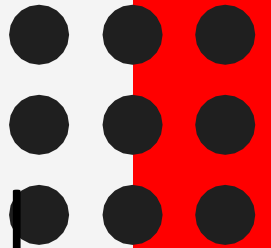

- Information asymmetry: a transmitting node might not be aware of the arrival times of packets queued at another node which is not within its transmission range
 - Solution: a receiver find that the sender is transmitting out of order, an out-of-order notification is piggy-backed by the receiver on the control packet (CTS/ACK)
- Perceived collisions: the ACK packet collides at the node, the corresponding entry in the ST will never be removed
 - Solution: when a node observes that its rank remains fixed while packets whose PR are below the priority of its packet are being transmitted, it deletes the oldest entry from its ST

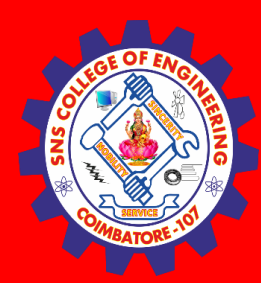

Assessment

List out the advantage and disadvantages of Contention based protocol with scheduling?





THANK YOU