



SNS COLLEGE OF ENGINEERING

Kurumbapalayam (Po), Coimbatore – 641 107

An Autonomous Institution

Accredited by NBA – AICTE and Accredited by NAAC – UGC with 'A' Grade

Approved by AICTE, New Delhi & Affiliated to Anna University, Chennai

DEPARTMENT OF ELECTRICAL AND ELECTRONICS ENGINEERING

COURSE NAME : 19EC309 ELECTRICAL MACHINES AND POWER SYSTEMS

II YEAR / 03 SEMESTER MECH & MCT

Unit 3 – INDUCTION MOTORS

Construction ,Working, Types & T-N Characteristics of Three Phase Induction Motor

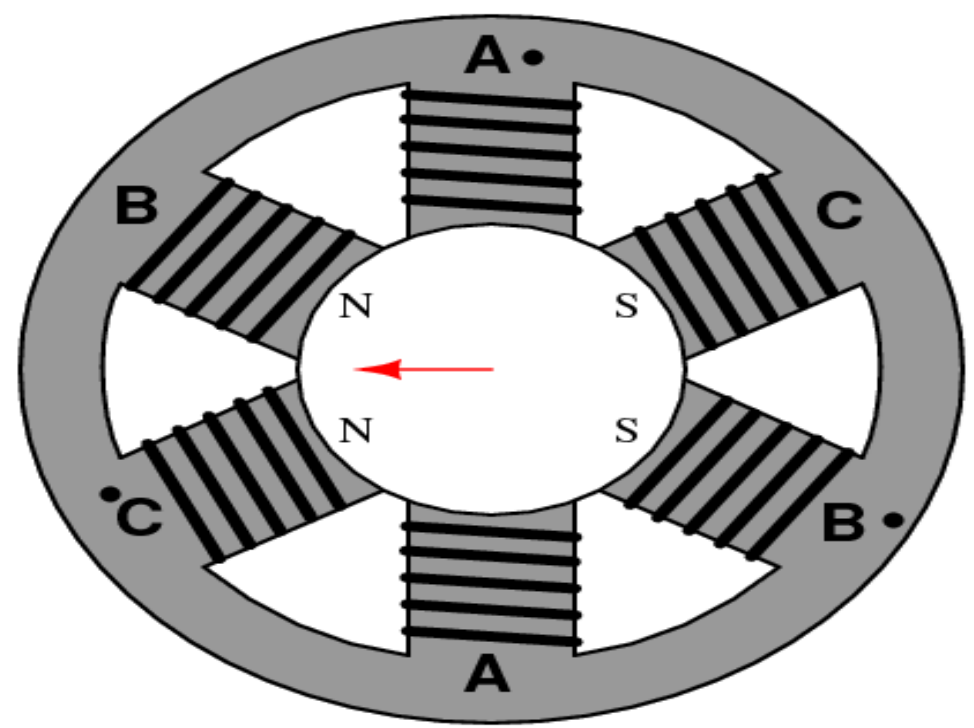
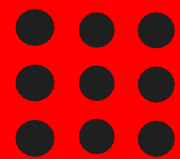

Induction Motor



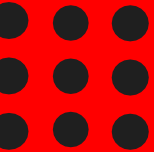

DC MOTORS | JUST TO REMIND YOU

Structure

- ❑ The **stator** is the outside stationary part of the motor.
- ❑ The rotor is the inner rotating part.
- ❑ In the animation:
 - ❖ **Red** represents a magnet or winding with a **North polarization**,
 - ❖ **Green** represents a magnet or winding with a **South polarization**.
 - ❖ Opposite, red and green, polarities attract.

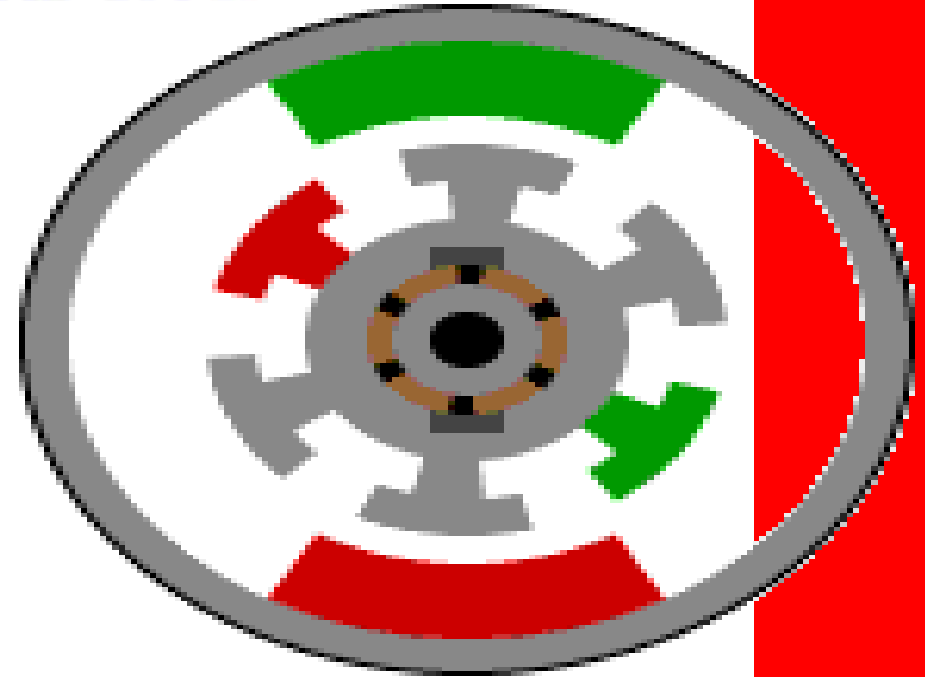

Operation

- ❑ As the rotor reaches alignment, the brushes move across the commutator contacts and energize the next winding.
- ❑ In the animation:
 - ❖ The commutator contacts are brown,
 - ❖ The brushes are dark grey.
 - ❖ A yellow spark shows when the brushes switch to the next winding.





AC MACHINES CONSTRUCTION

Just Like dc Machines, ac Machines also consist of

□ **Stator**, and

□ **Rotor**.

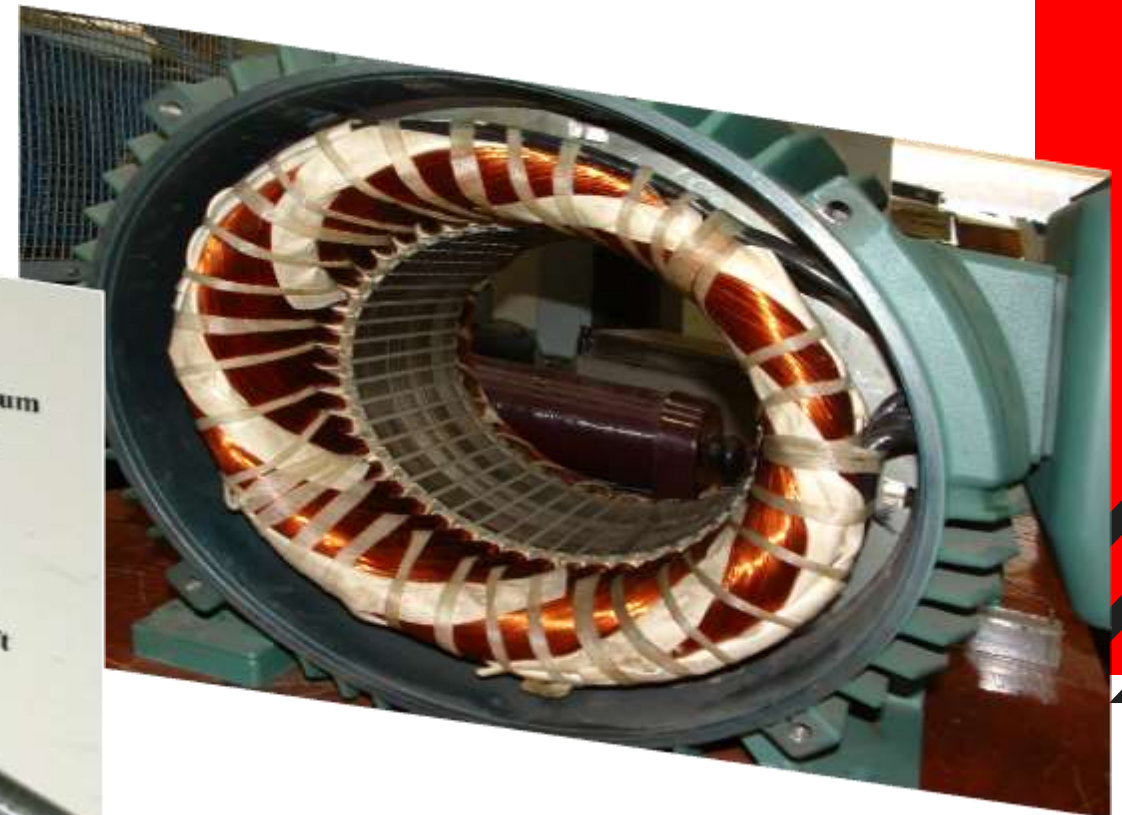
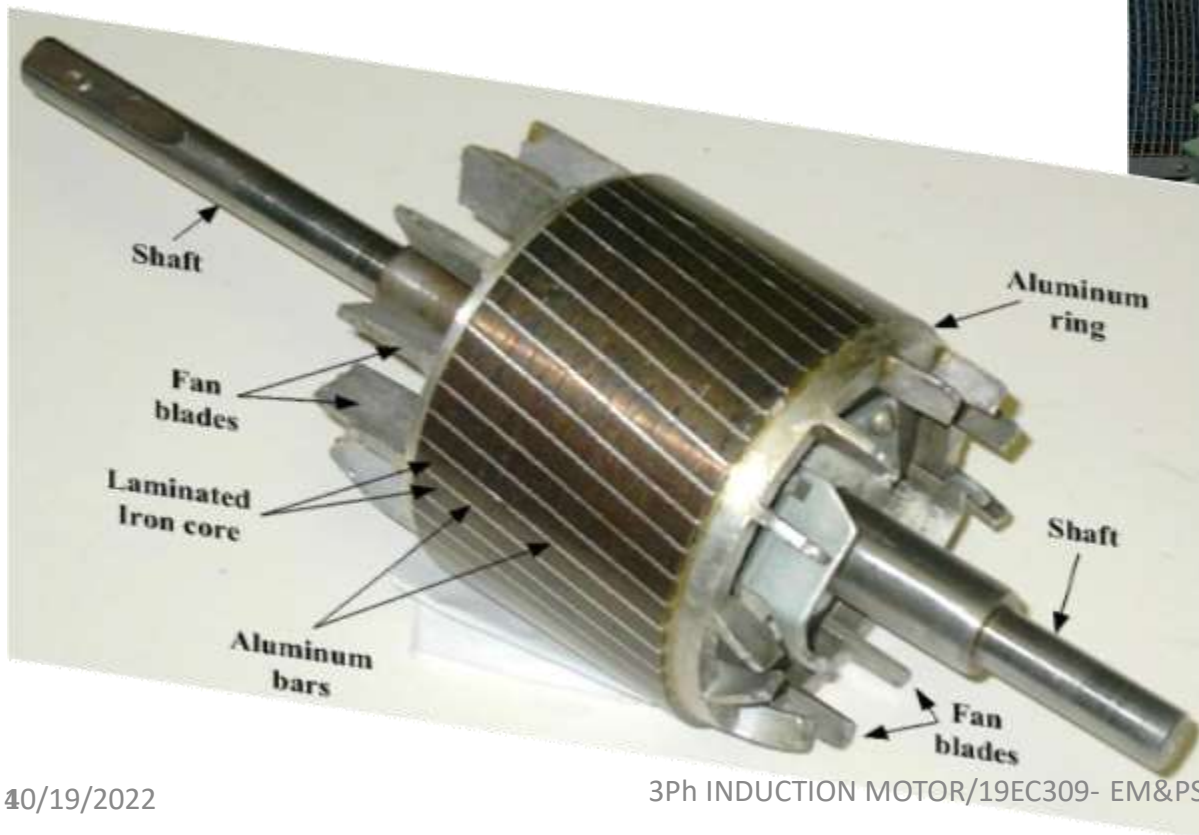



The Stator:

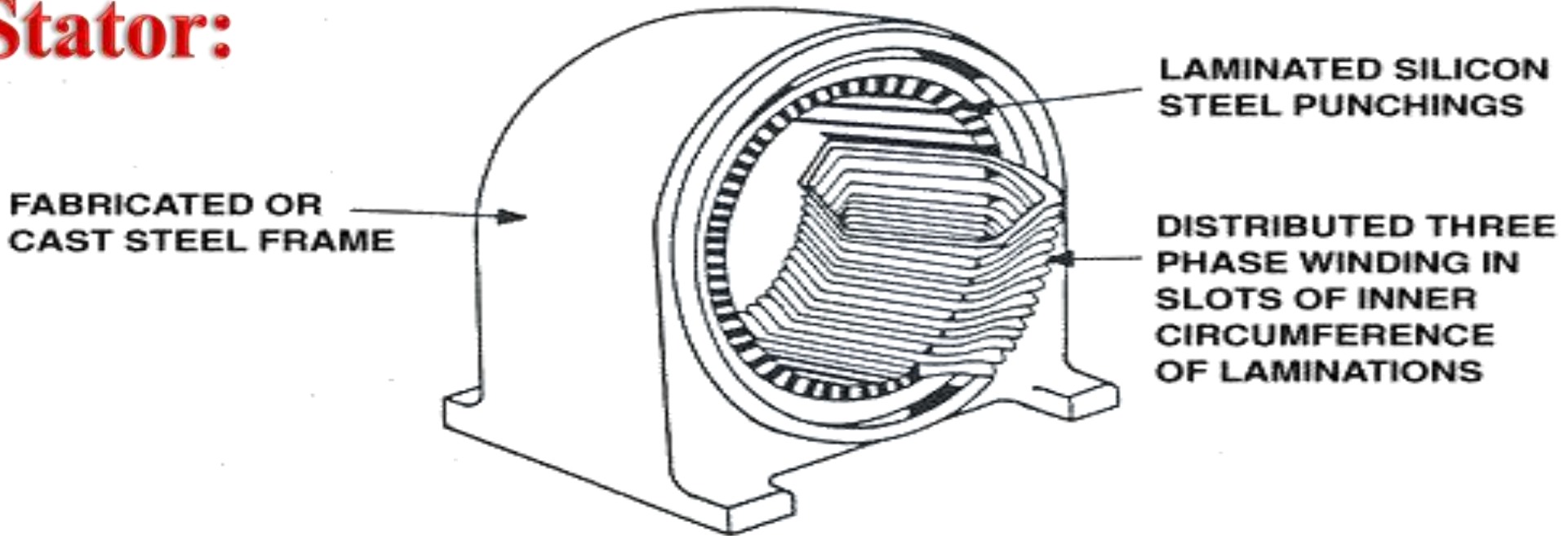

- ❑ The outer stationary steel frame enclosing a hollow, cylindrical core. (Frame – Si & Al Alloy)
- ❑ A large number of circular **silicon steel (core)** laminations (0.35mm – 0.65mm thickness) with slots cut in the inner circumference.
- ❑ **Three phase windings mutually displaced by 120° are wound in these slots.**
- ❑ The greater the number of poles, the lesser is the speed and vice-versa.
- ❑ **Three phase supply induces rotating magnetic field.**
- ❑ Air gap between the stator and rotor ranges 0.4mm to 4mm, determines the power of the motor



The Rotor is the inner rotating section

❑ **Squirrel Cage** is the most common form of rotor:

- ❖ Laminated cylindrical core with parallel slots at the outer periphery
- ❖ Copper or aluminium bars are placed in the slots
- ❖ All the bars are welded at each end by metal rings called “End rings”
- ❖ **End rings** are sometimes castellated to facilitate cooling.
- ❖ It is not connected to the supply and operates on the transformer principle

❖ **Advantages:** This is a simple and robust construction

❖ **Disadvantage:** Low starting torque as it is not possible to add external resistance.

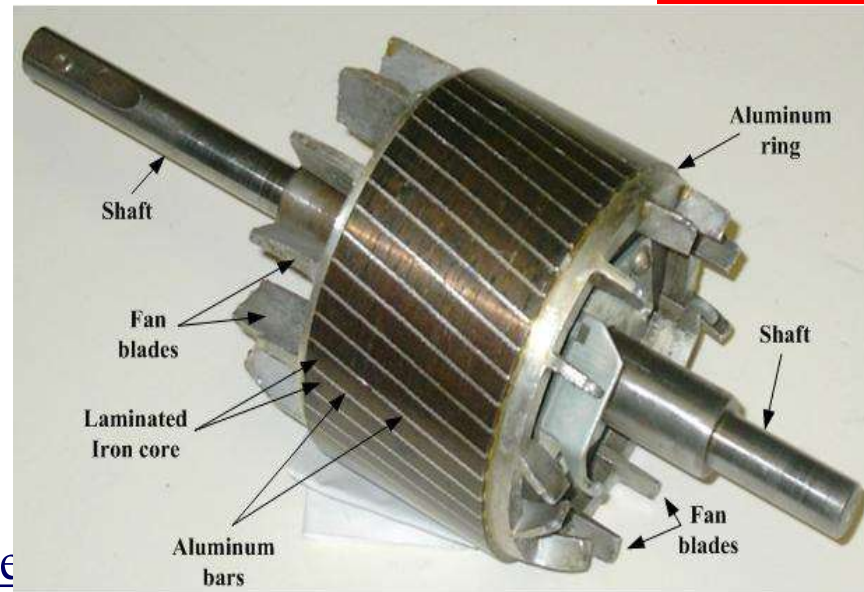

❑ **Wound**

- ❖ Laminated cylindrical core
- ❖ Has star connected three phase winding
- ❖ Open ends are connected to three separate insulated slip rings(phosphor-bronze or brass)
- ❖ External resistances are connected to increase the starting torque.

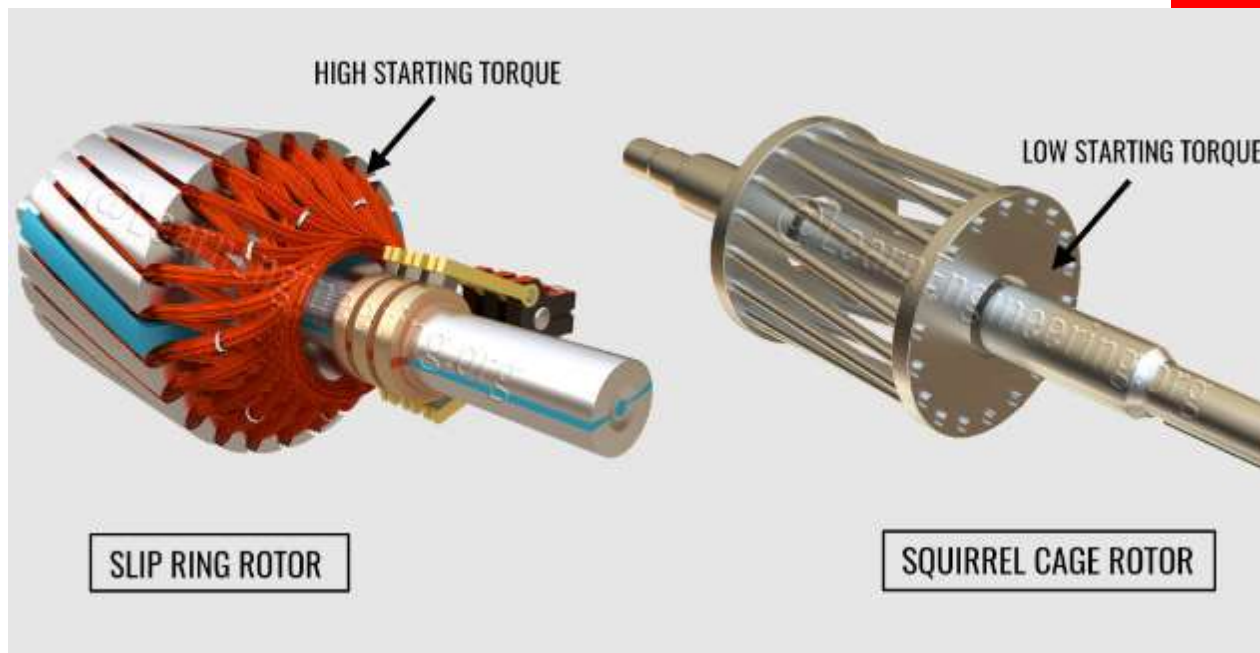



FUNDAMENTAL PRINCIPLE OF OPERATION

ROTATING SINUSOIDAL WINDING

The fundamental principle of operation

Is:

- ❑ The generation of a rotating magnetic field,
- ❑ This causes the rotor to turn at a speed that depends on the speed of rotation of the magnetic field

A uniform rotating magnetic field is produced in the air gap between the rotor and stator by applying balanced 3 phase supply.

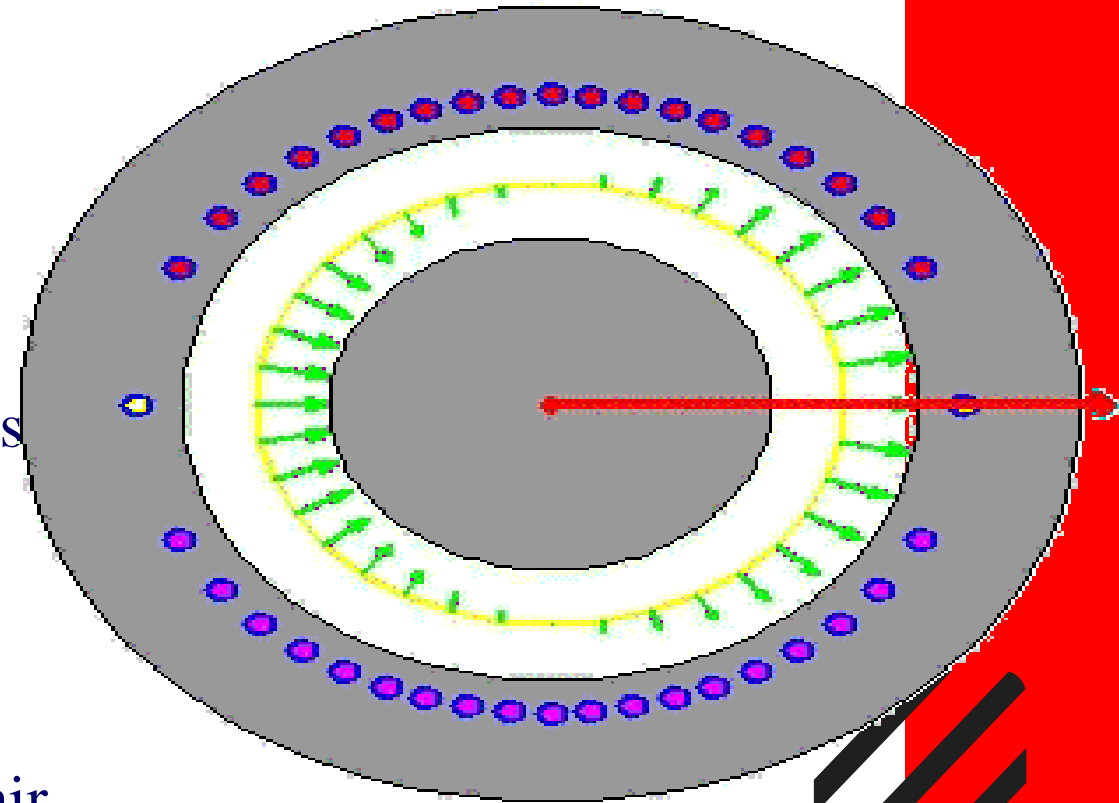

FLUX DENSITY DISTRIBUTION



PRINCIPLE OF OPERATION

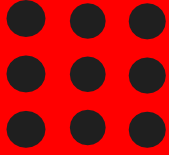

- ❑ The stator supports windings **a-a**, **b-b** and **c-c**, which are geometrically spaced 120° apart.
- ❑ Therefore, the currents generated by a 3-phase source are also spaced by 120° .

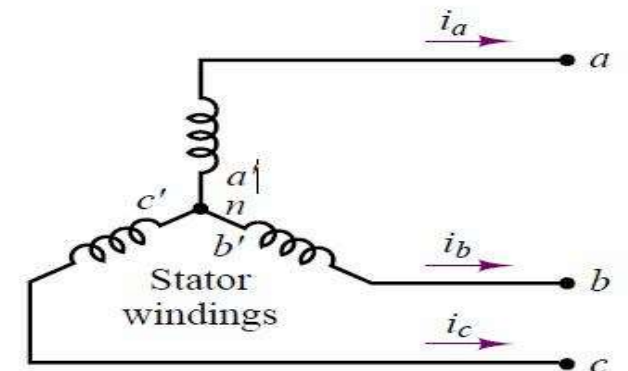
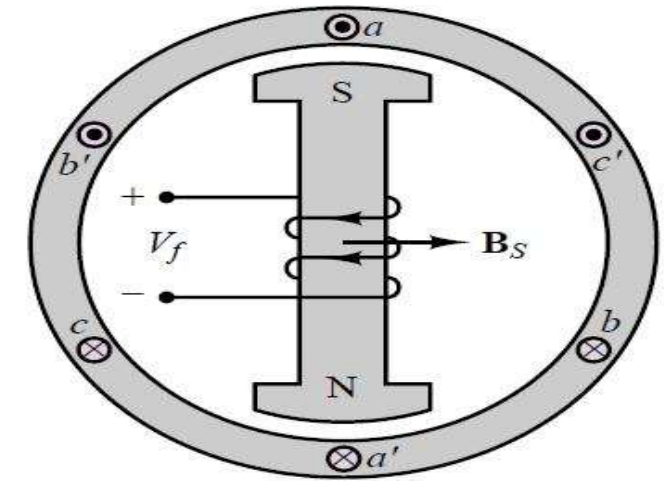
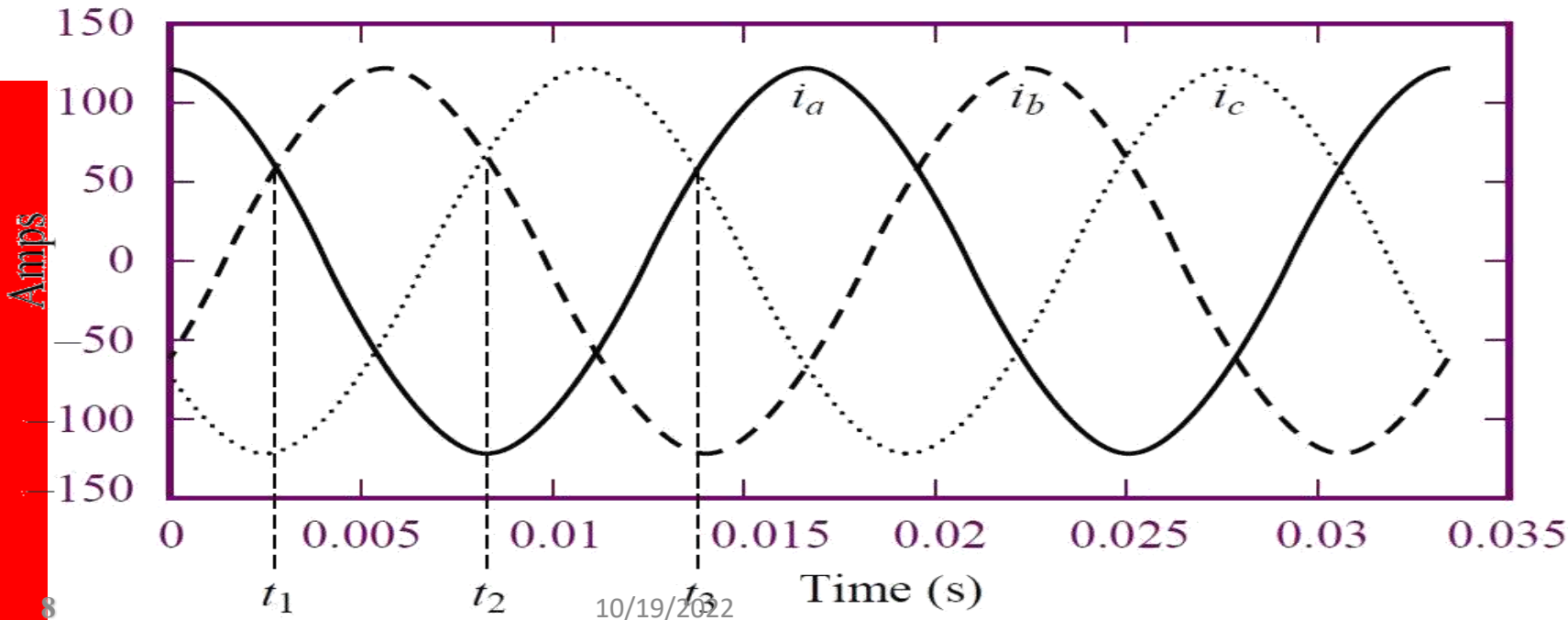

Amps

10/19/2022





Since the resultant flux is generated by the currents, the speed of rotation of the flux must be related to the frequency of the sinusoidal phase currents.

The number of magnetic poles resulting from the stator winding configuration is two. However, it is possible to configure the windings so that they have more poles.

In general,

The speed of the rotating magnetic field is determined by the frequency of the excitation current, **f**, and

By the number of poles present in the stator, **p**, according to the equation

$$n_s = \frac{120}{p} f \text{ rev/min}$$

$$\omega_s = \frac{2\pi n_s}{60} = \frac{2\pi f}{p} \text{ rev/min}$$

where n_s (or ω_s) is usually called the *synchronous speed*.

ROTATING SINUSOIDAL WINDING

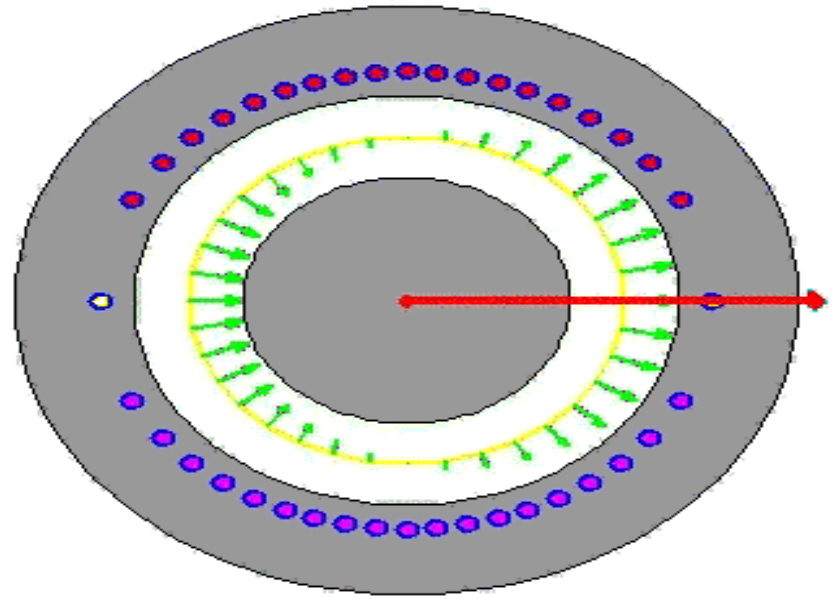

FLUX DENSITY DISTRIBUTION

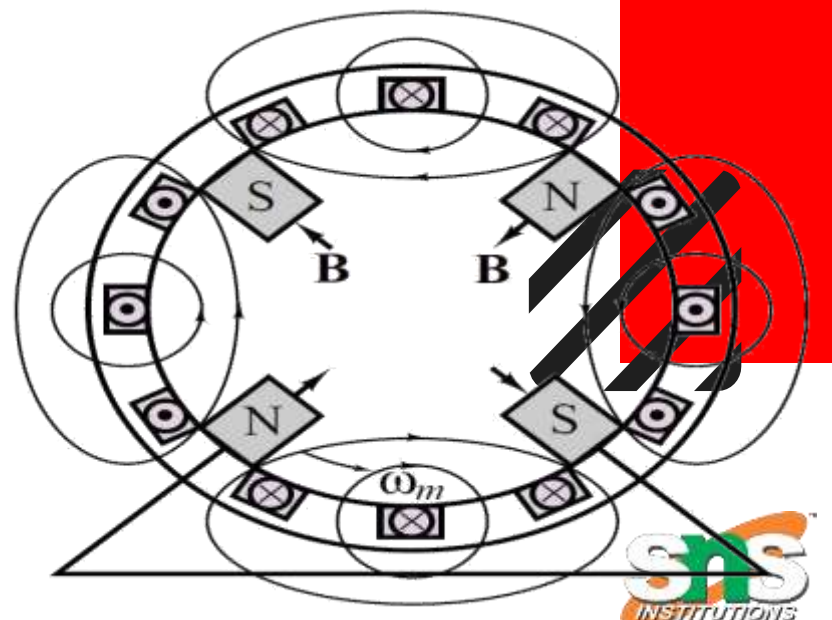

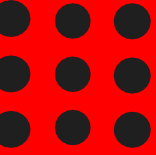

- ❑ The stator magnetic field rotates in an AC machine, and
 - ❖ therefore the rotor cannot “catch up” with the stator field and is in constant pursuit of it.
 - ❖ The speed of rotation of the rotor will therefore depend on the number of magnetic poles present in the stator and in the rotor.
- ❑ The magnitude of the torque produced is a function of the angle γ between the stator and rotor magnetic fields
- ❑ The number of stator and rotor poles must be identical if any torque is to be generated.





ROTATING SINUSOIDAL WINDING

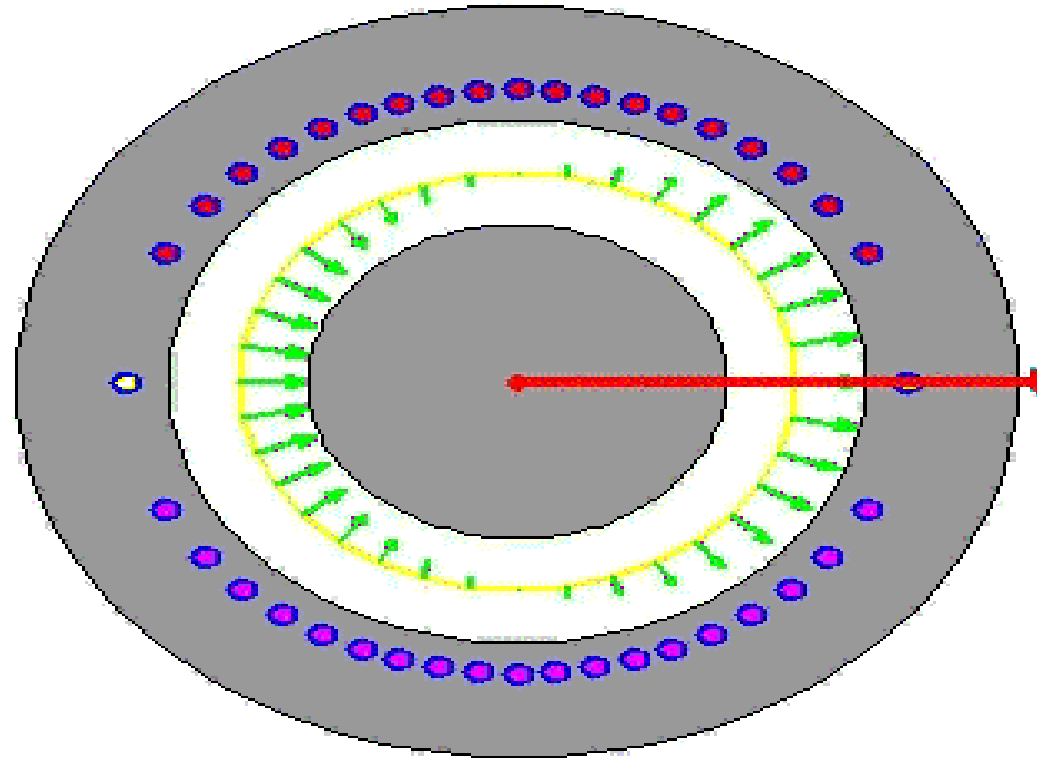

FLUX DENSITY DISTRIBUTION

It is important to generate a constant electromagnetic torque to avoid torque pulsations

Pulsations could lead to undesired mechanical vibration in the motor itself and in other mechanical components attached to the motor (e.g., mechanical loads, such as spindles or belt drives).



THREE PHASE CURRENTS

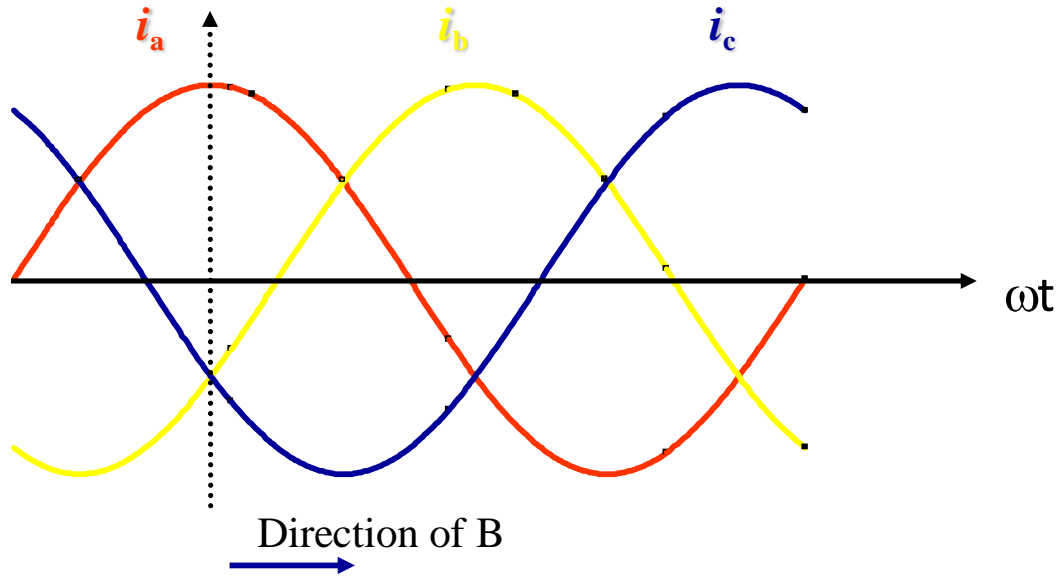

$$i_a = I_m \cos \omega t$$

$$i_b = I_m \cos (\omega t - 120^\circ)$$

$$i_c = I_m \cos (\omega t + 120^\circ)$$

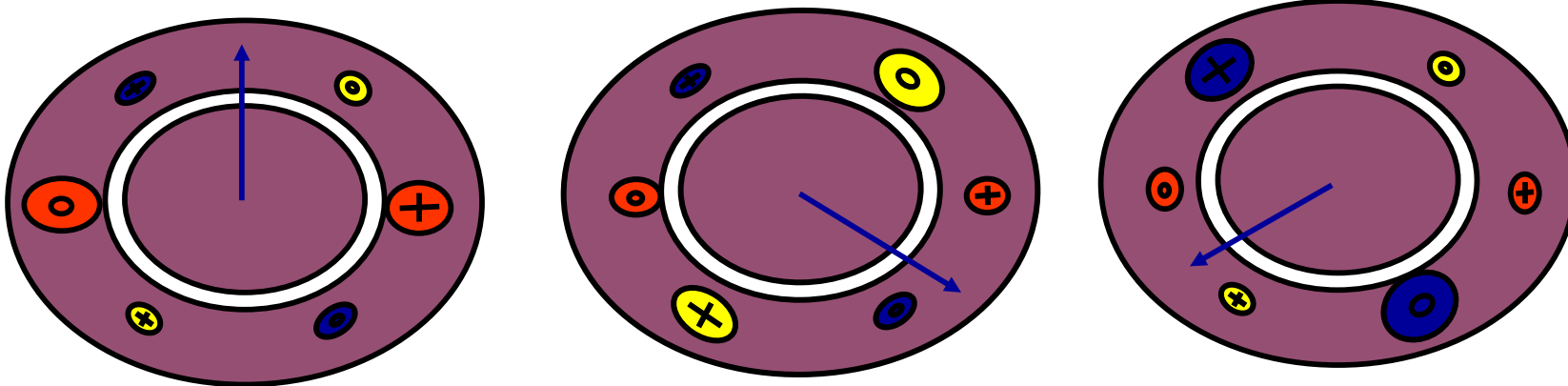

A Current Maximum

B Current Maximum

C Current Maximum

Time



ROTATING MAGNETIC FIELD

Assume that the current waveforms are as in the top Figure.

□ At the moment $t = 0$:

- ❖ Red phase current is at positive maximum
- ❖ Yellow and Blue phase currents are both at negative half-maximum.

Each of these currents produces a magnetic field. These fields interact to form the net field shown in the first sequence in the Figure.

The magnetic field resembles that associated with a two pole bar magnet. As a consequence the machine is called a 2-pole motor.

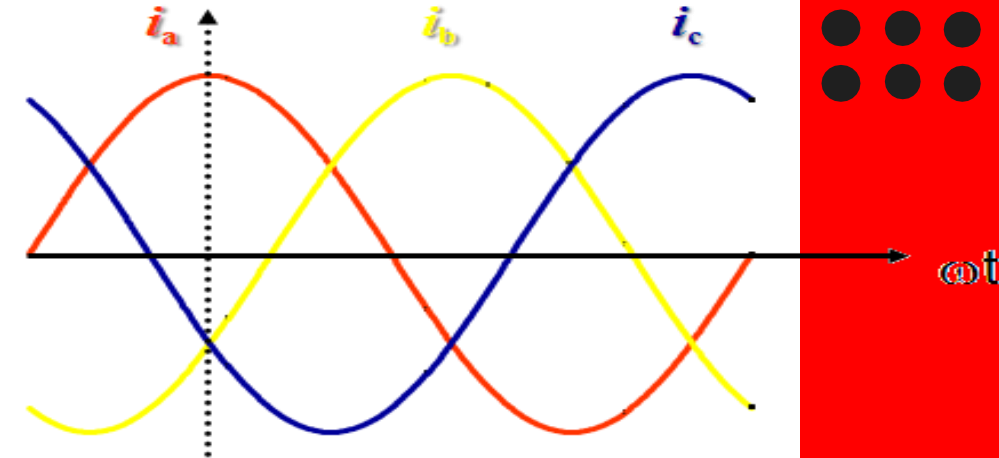

$t = 0$, red at positive maximum

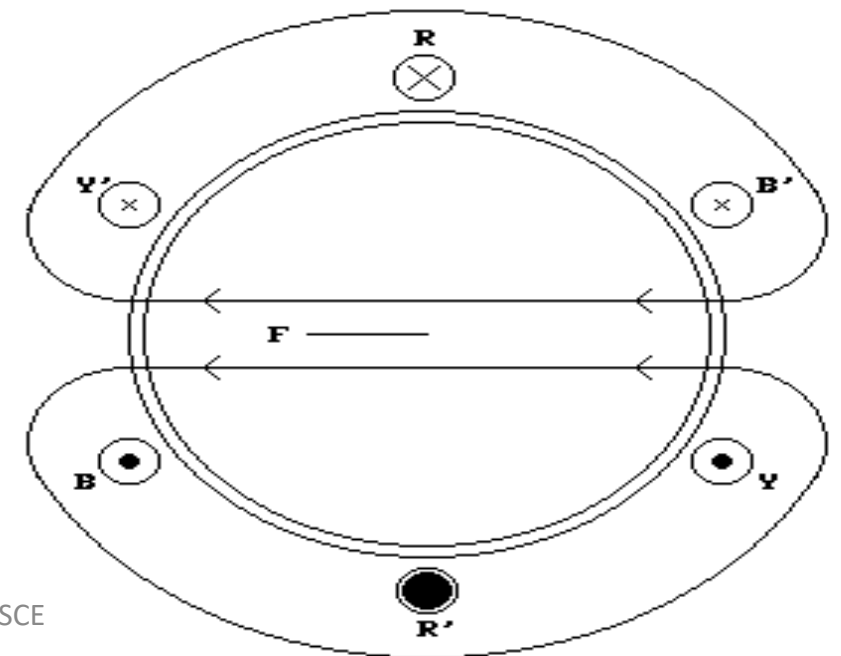



ROTATING MAGNETIC FIELD

As time increases the current distribution changes:

- ❑ The red current falls;
- ❑ The yellow current becomes less negative eventually becoming positive and
- ❑ The blue current approaches negative maximum.

As these changes take place the net field, which maintains a constant magnitude, rotates clockwise

Hence, the second sequence shows the position after 1/3rd cycle (120 electrical degrees):

- ❑ The yellow current is at positive maximum and
- ❑ Red and Blue current are both at negative half-maximum.

At this time, the field has rotated 120° from its original position.

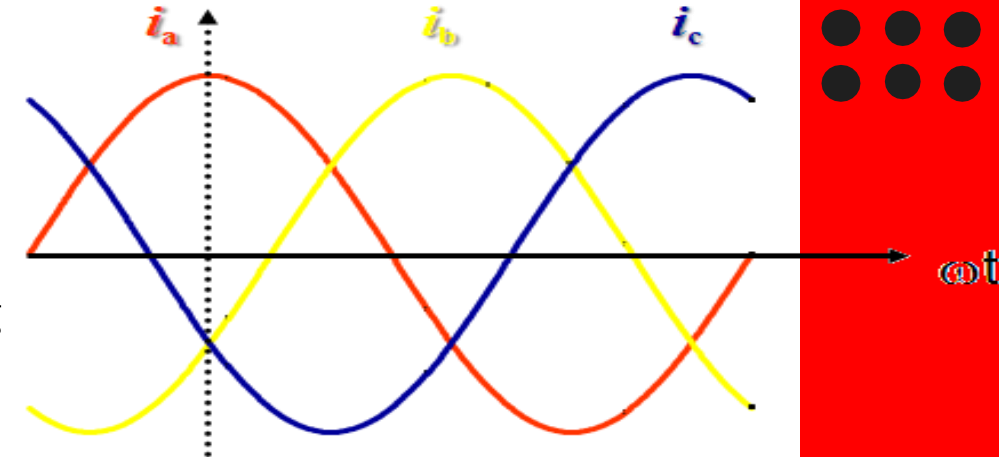

$t = 1/3f$, (1/3rd of a cycle later)
yellow at positive maximum

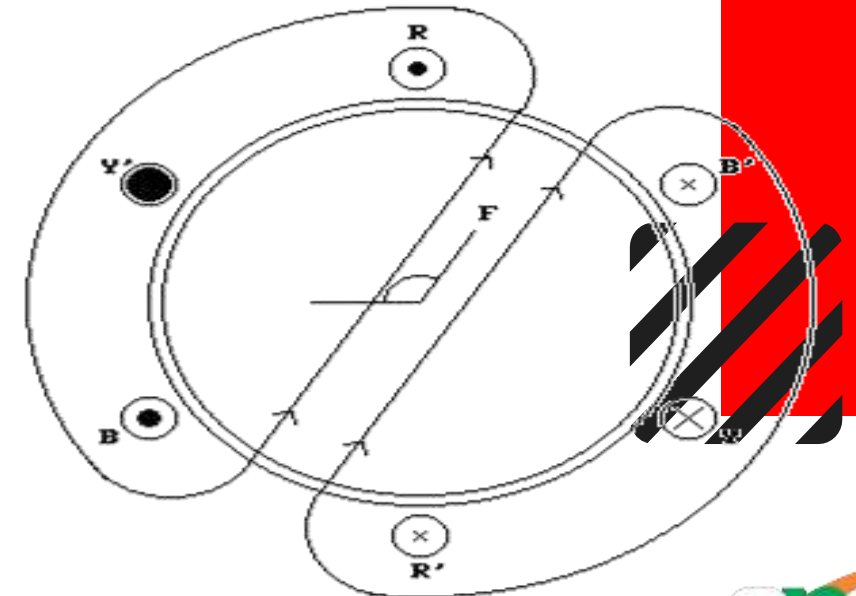

field in the air gap has moved clockwise through 120 degrees

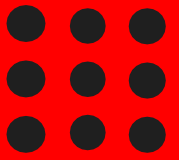



ROTATING MAGNETIC FIELD

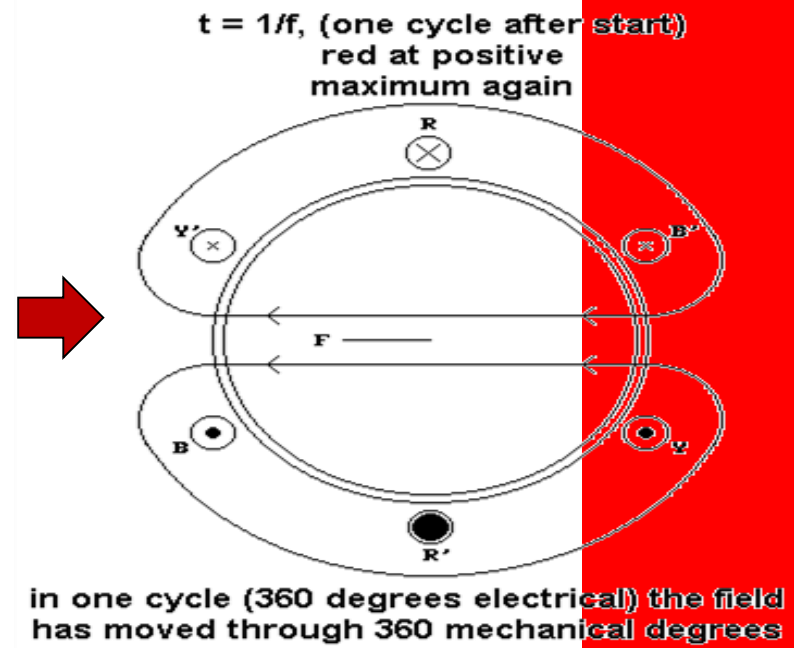
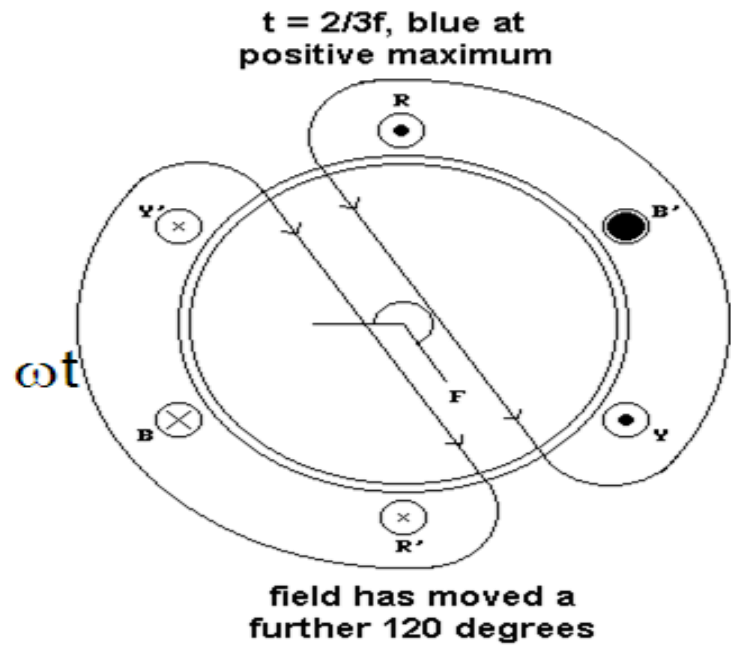
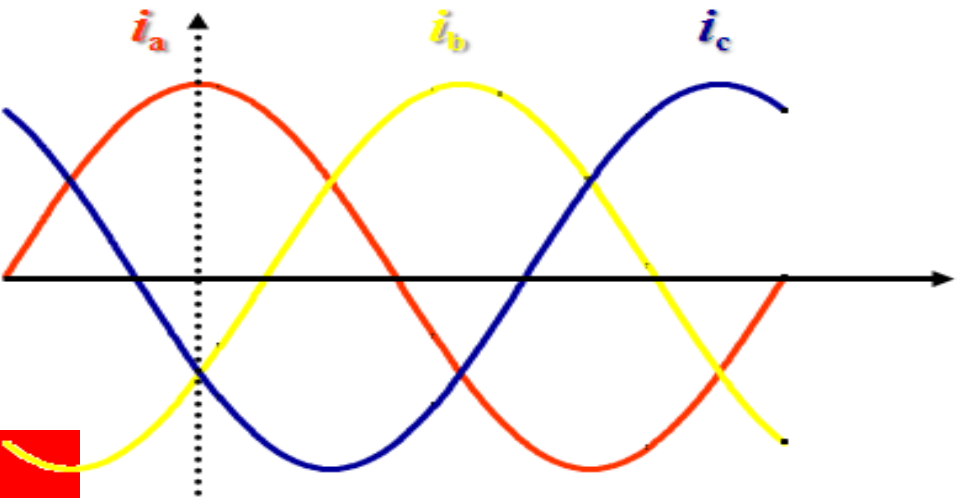
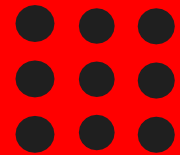

- ❑ After $2/3^{\text{rd}}$ cycle (third sequence) the field has moved a total of 240° and after one complete cycle (last sequence) the field has returned to its original position.
- ❑ The net field rotates at what is called the synchronous speed, n_s .
- ❑ This speed in revolutions per second is equal to the frequency, f , in hertz (Hz) or cycles per second, of the stator currents.





ROTOR SLIP

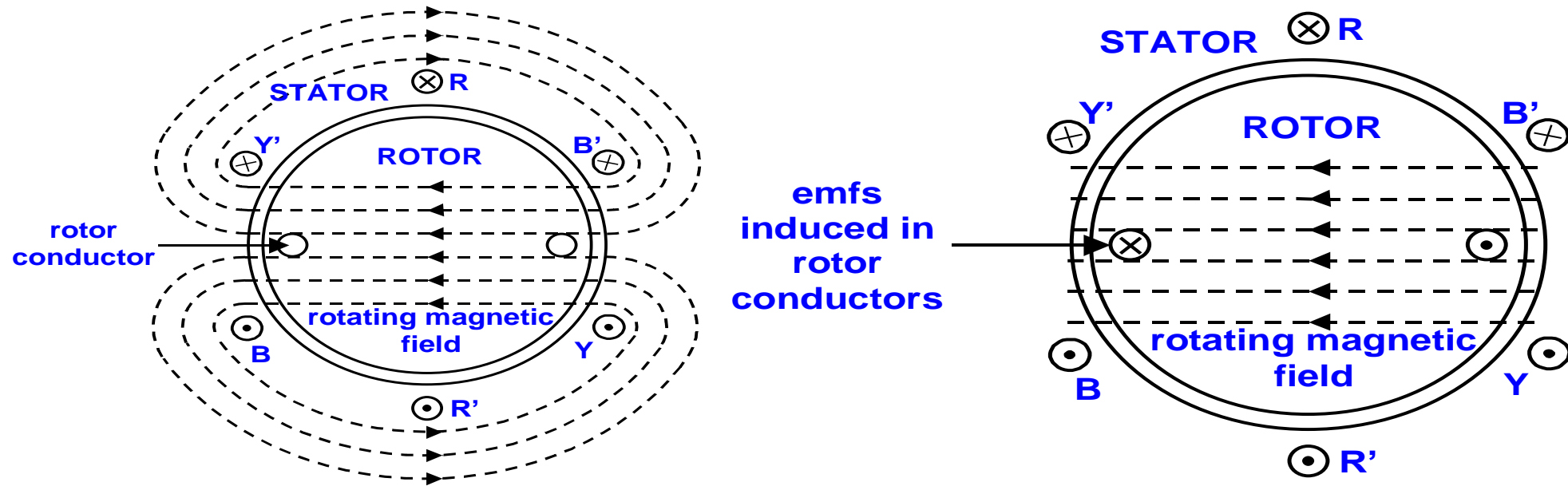

Consider a simple rotor, with one short circuited coil, inserted within the stator:

- Initially, the rotor is stationary.
- The moment the stator supply is switched on currents start to flow and the rotating magnetic field is established.
- The relative motion between the moving field and the stationary rotor conductors induces emf in the stationary rotor conductors (in accordance with Faraday's Law)



ROTOR SLIP

- ❑ Current start flowing in the conductors as they are short circuited by the end rings.
- ❑ These currents create their own magnetic fields, which interact with the rotating stator field to produce forces on the individual conductors and a net rotor torque

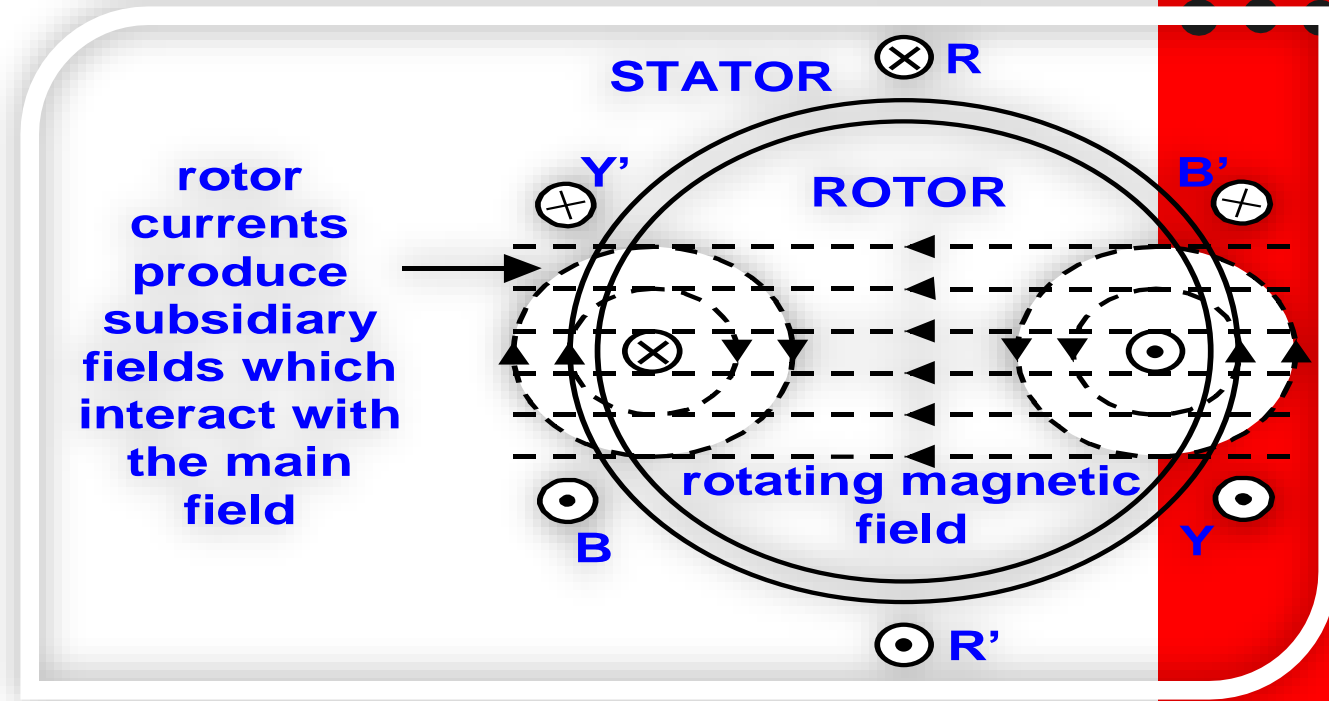

- ❑ The rotor starts to accelerate lowering the relative speed between the rotating field and rotor conductors.
 - ❖ This reduces the induced emfs, conductor currents and subsidiary magnetic fields;
 - ❖ thus decreasing the forces on the conductors and electrical torque on the rotor.



rotor currents produce subsidiary fields which interact with the main field

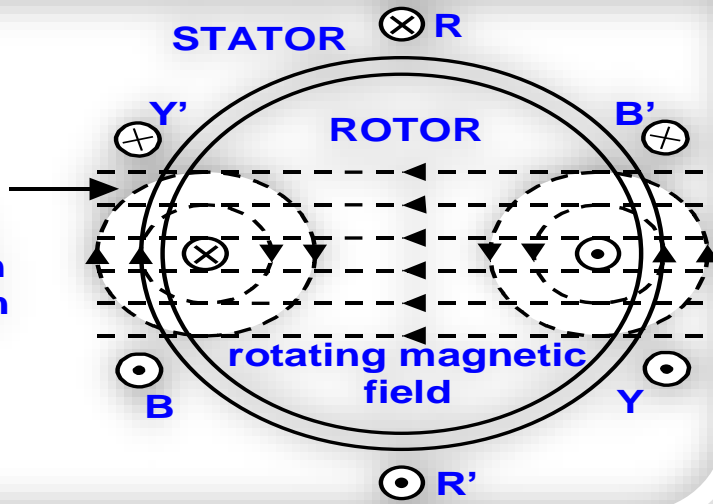

field is distorted exerting forces on the conductors and hence a rotor torque

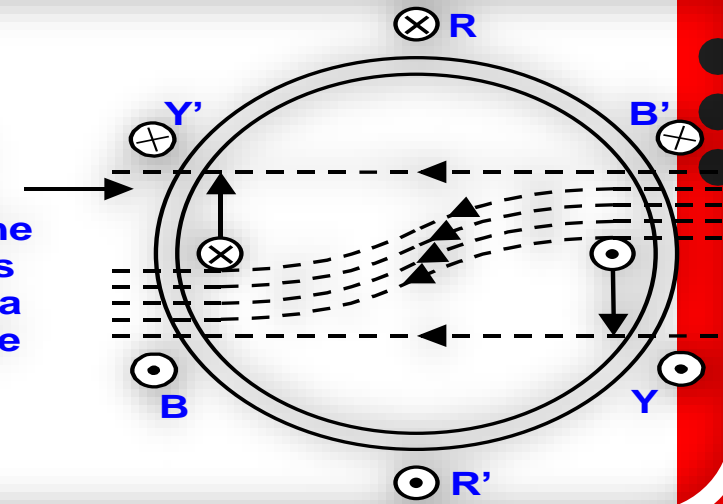

The rotor continues to accelerate until the electrical torque exactly equals the mechanical load torque on the shaft.

- ❖ At this point the rotor is running at a speed slightly slower than the rotating field.
- ❖ This small difference in speed is needed.
- ❖ In order to create an electrical torque there must be some distortion of the net field, which will only happen when currents flow in the rotor conductors.
- ❖ These currents depend on emfs being induced in the conductors, which in turn depend on there being a difference between the speed at which the conductors rotate and that of the rotating magnetic field.



rotor currents produce subsidiary fields which interact with the main field

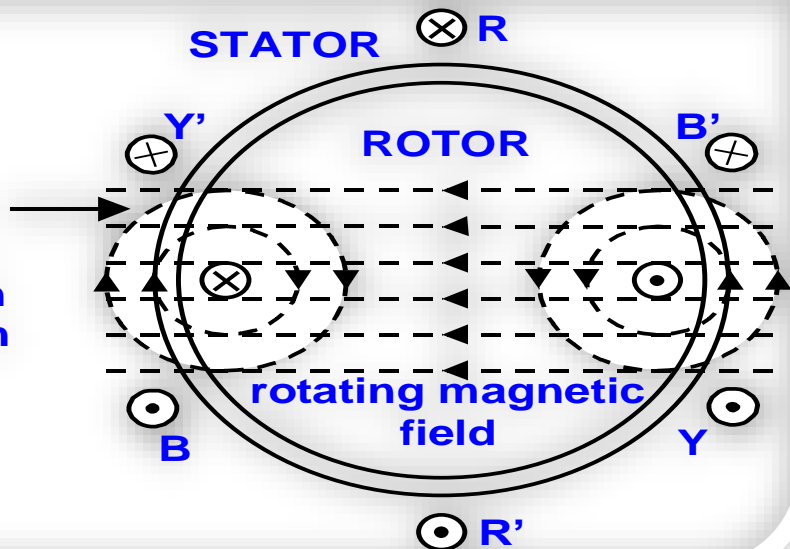

field is distorted exerting forces on the conductors and hence a rotor torque

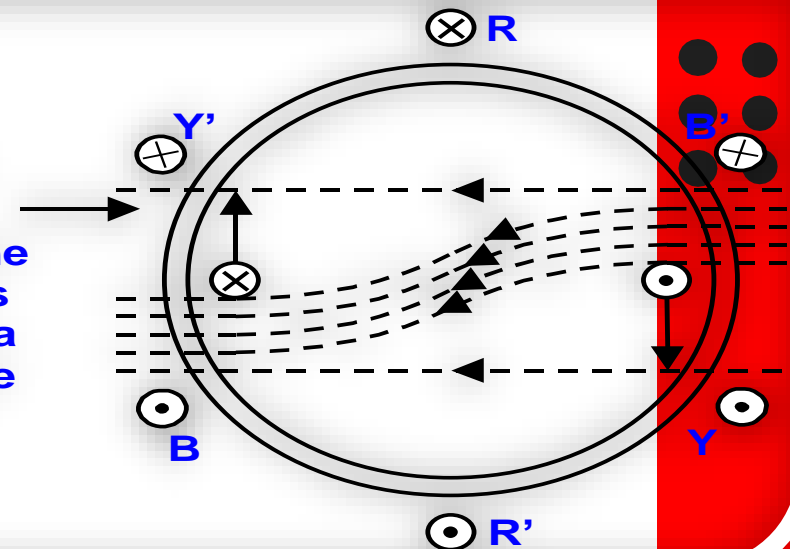

This difference in speed is expressed as a ratio known as the (per unit) slip.

Remembering that the rotational speed of magnetic field is known formally as the synchronous speed, the slip is defined as

$$\text{Slip} = \frac{(\text{synchronous speed, } n_s) - (\text{actual rotor speed, } n)}{(\text{synchronous speed, } n_s)}$$

For most machines the value of the slip varies between around 0.01 on no-load, (when the only torque required is to overcome friction at the bearings) and 0.10 at full load.



What will happen if the rotor reaches the speed of the stator flux?

- ❖ No relative speed between stator field and rotor conductor
- ❖ No induced current
- ❖ No torque

Is it practically possible?

No, Because friction will slow down the rotor

Hence the rotor speed is always less than the stator rotating field speed and the difference is called “Slip”

$$\text{Slip} = \frac{(\text{synchronous speed, } n_s) - (\text{actual rotor speed, } n)}{(\text{synchronous speed, } n_s)} = \frac{n_s - n}{n_s} = 1 - \frac{n}{n_s}$$

Note: For a stationary rotor the slip is 1; Generally the change in slip from no load to full load is 0.01 to 0.1 so the speed of the motor is constant.



TORQUE-SLIP CHARACTERISTICS

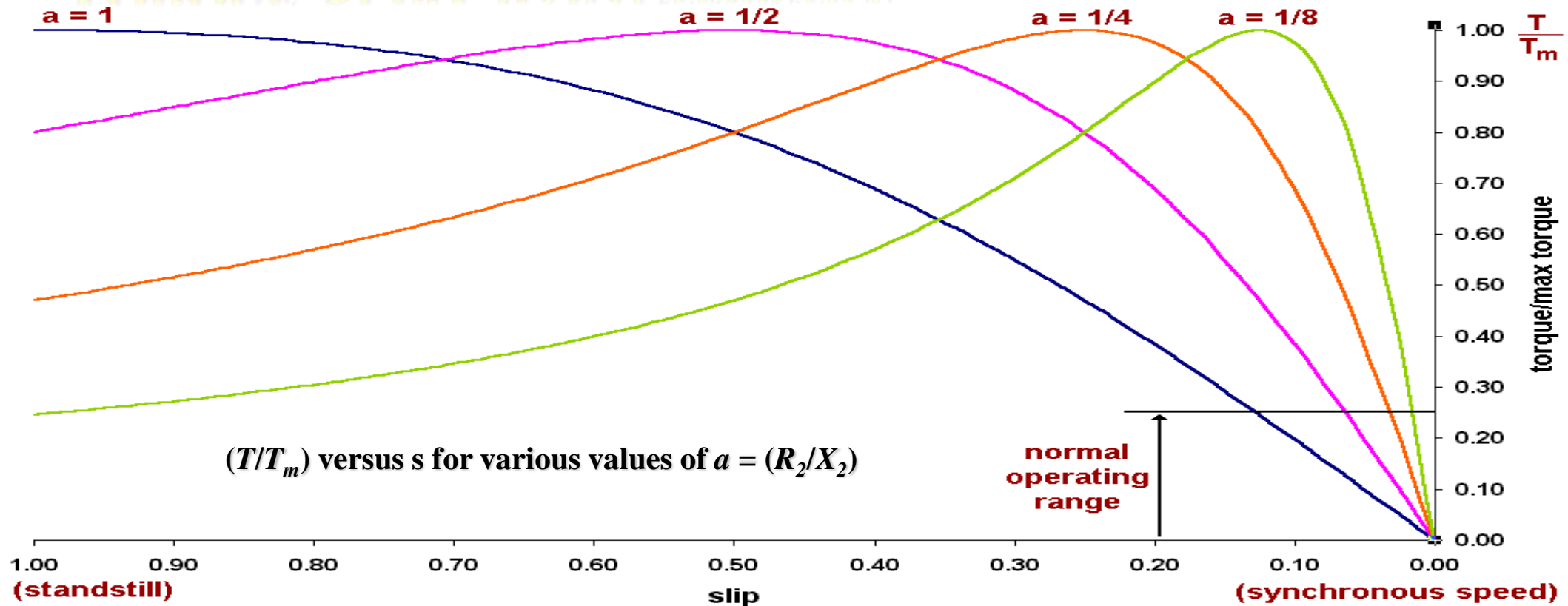

The graphs show that in steady state conditions induction motors with the smallest value of “ a ” run at practically constant speed over the normal operating range of the machine. Unfortunately, these machines generally have poor starting torques and for a motor to start it is necessary that **Starting torque > load torque**



TORQUE-SPEED CHARACTERISTICS

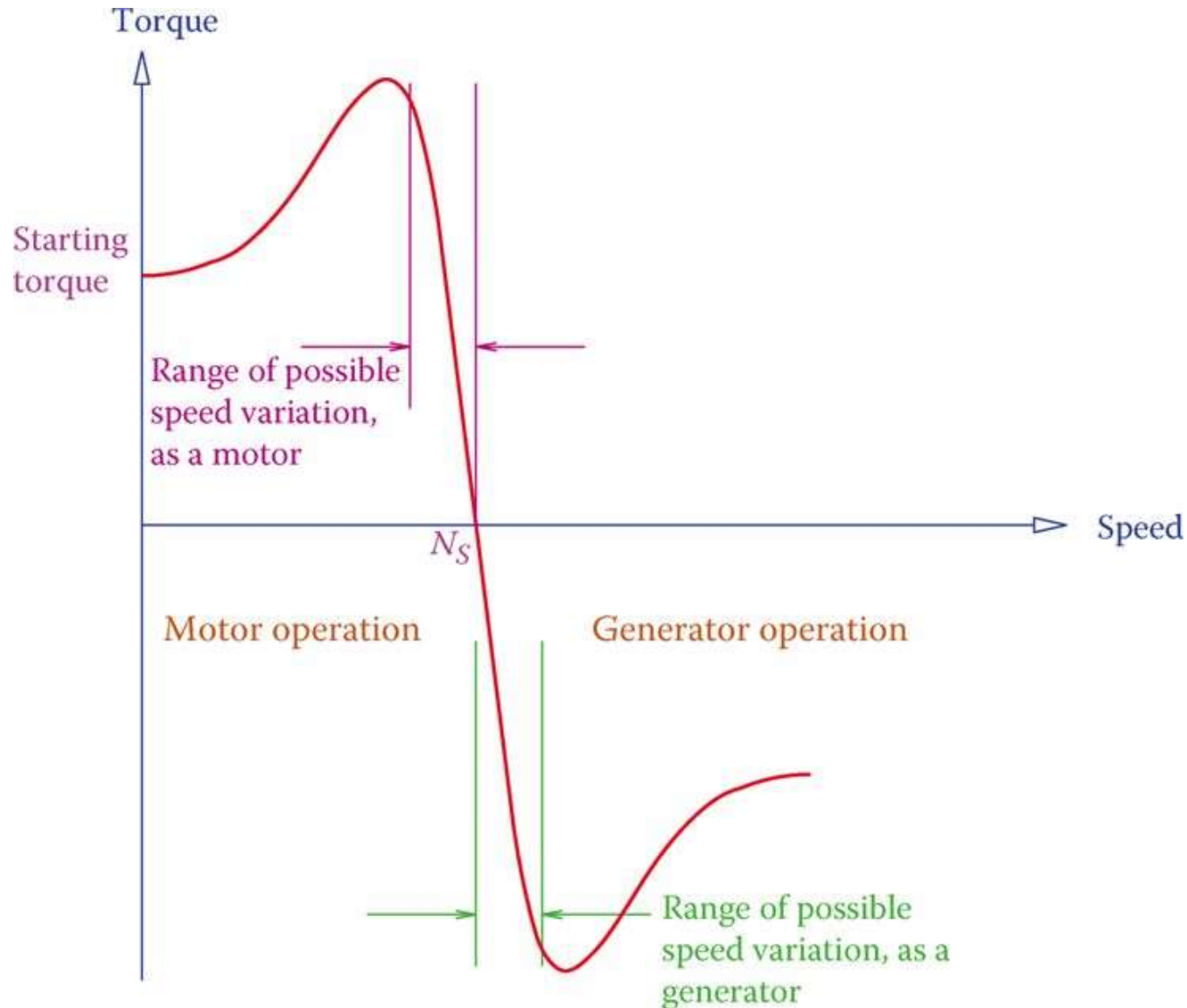

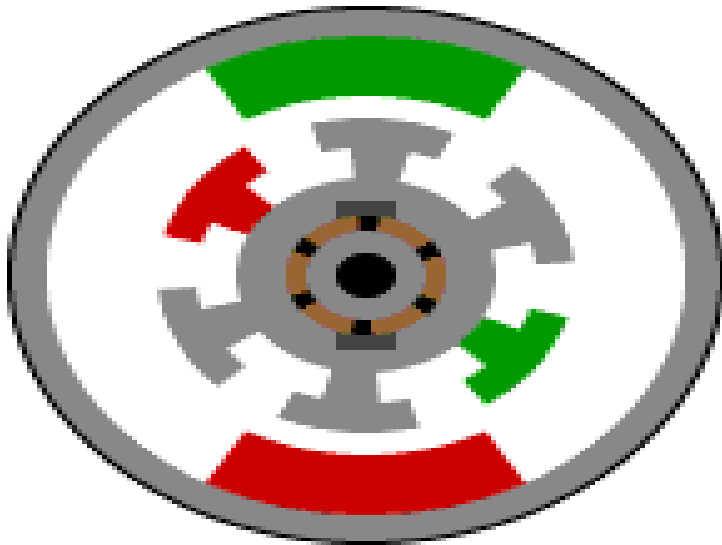

DC MOTORS

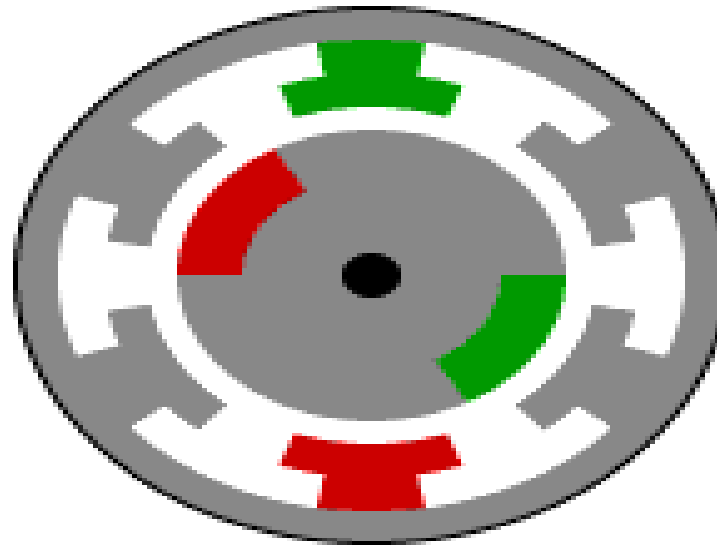

BRUSHLESS DC MOTORS

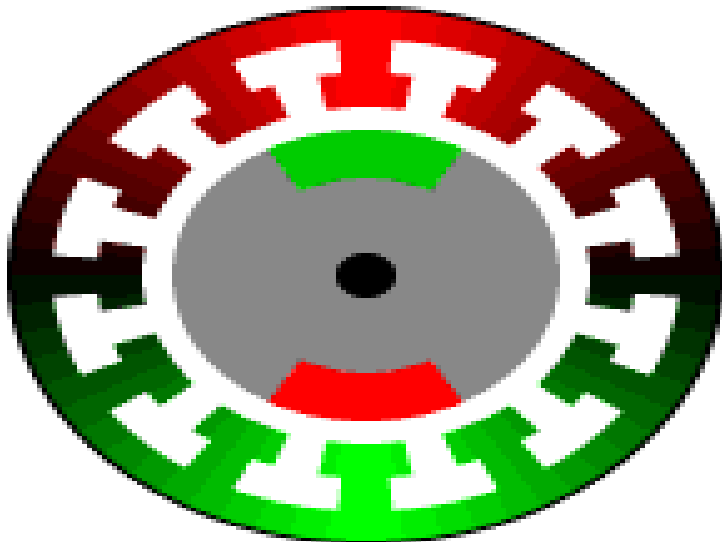

BRUSHLESS AC MOTORS

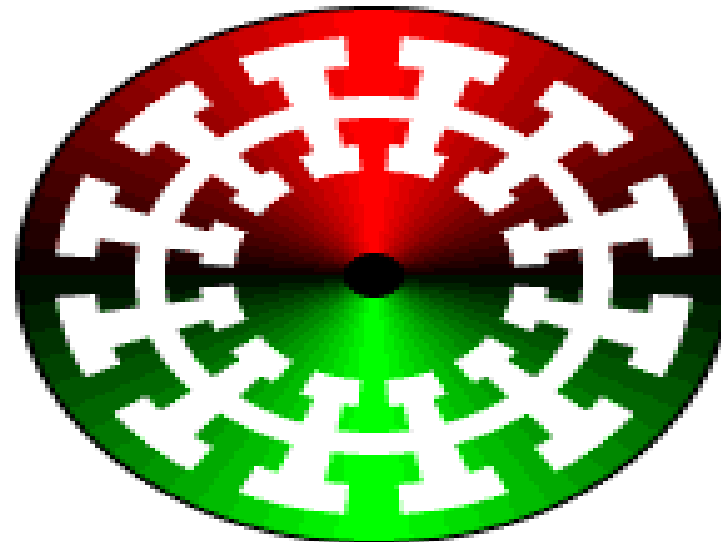

AC INDUCTION MOTOR

