

An Autonomous Institution

Accredited by NBA – AICTE and Accredited by NAAC – UGC with ‘A+’ Grade
Approved by AICTE, New Delhi & Affiliated to Anna University, Chennai

DEPARTMENT OF INFORMATION TECHNOLOGY

19CSB302 – COMPUTER NETWORKS

III YEAR V SEM

UNIT 1 – FUNDAMENTALS AND PHYSICAL LAYER

TOPIC 1 – Layering and Protocols (ISO/OSI Model)

We use the concept of **layers** in our daily life. As an example, consider two friends who communicate through postal mail. Transmitting a letter to a friend would be complex if there were multiple people from the post office.

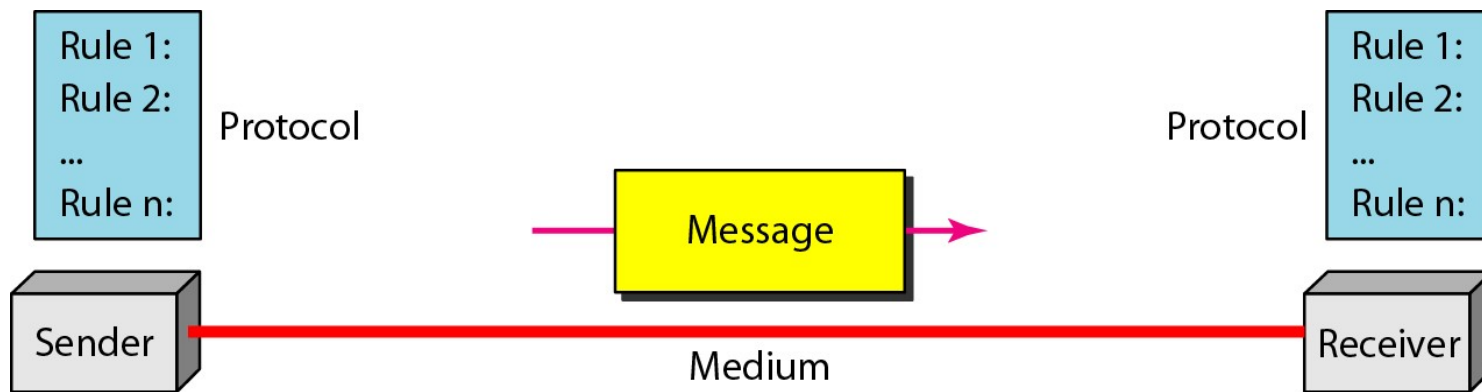

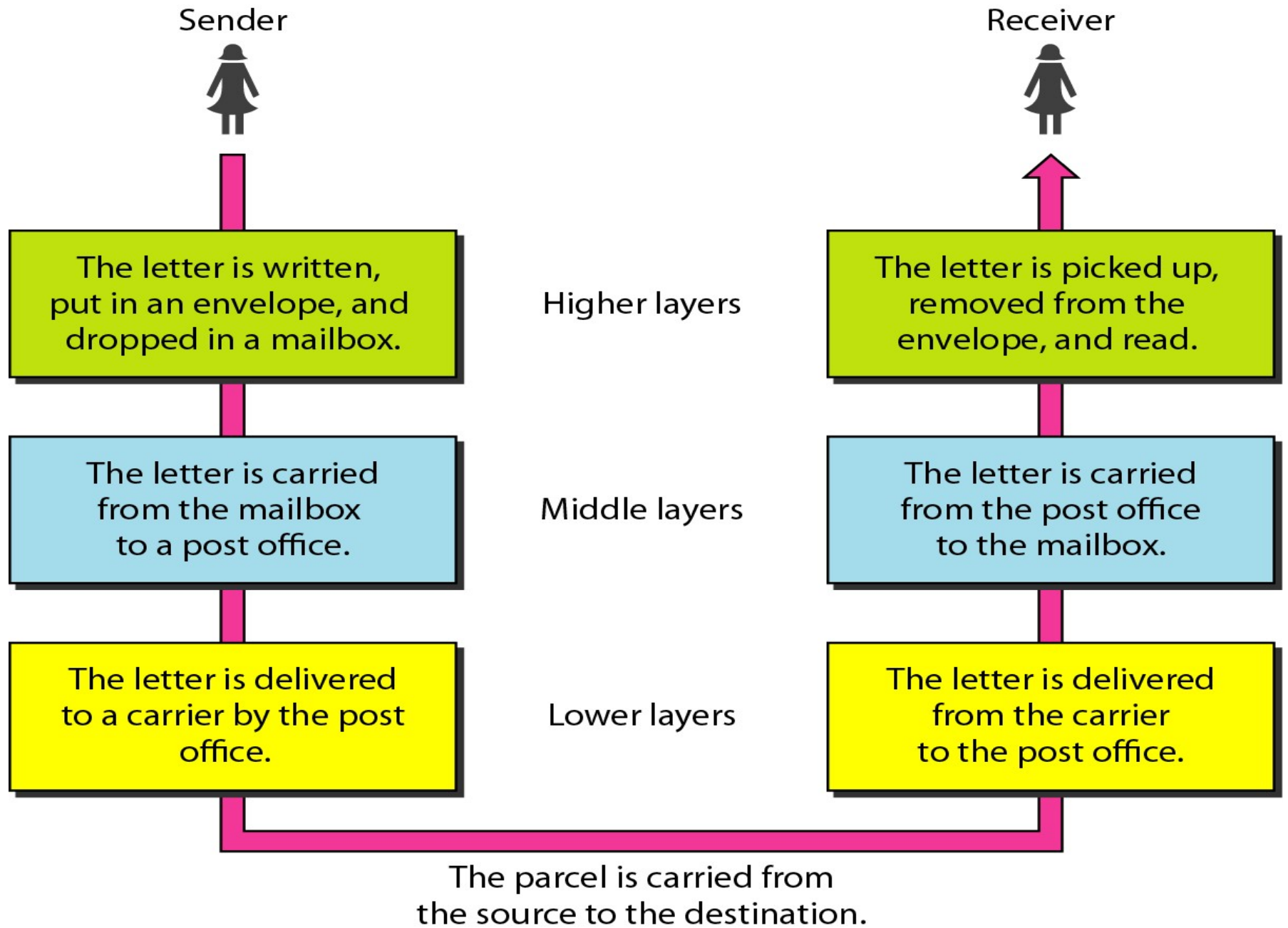

The OSI Model

Established in 1947, the International Standards Organization (ISO) is an international body dedicated to worldwide agreement on standards. An ISO standard that covers all aspects of communications is the Open Systems Interconnection (OSI) model, introduced in the late 1970s.

ISO is the organization.

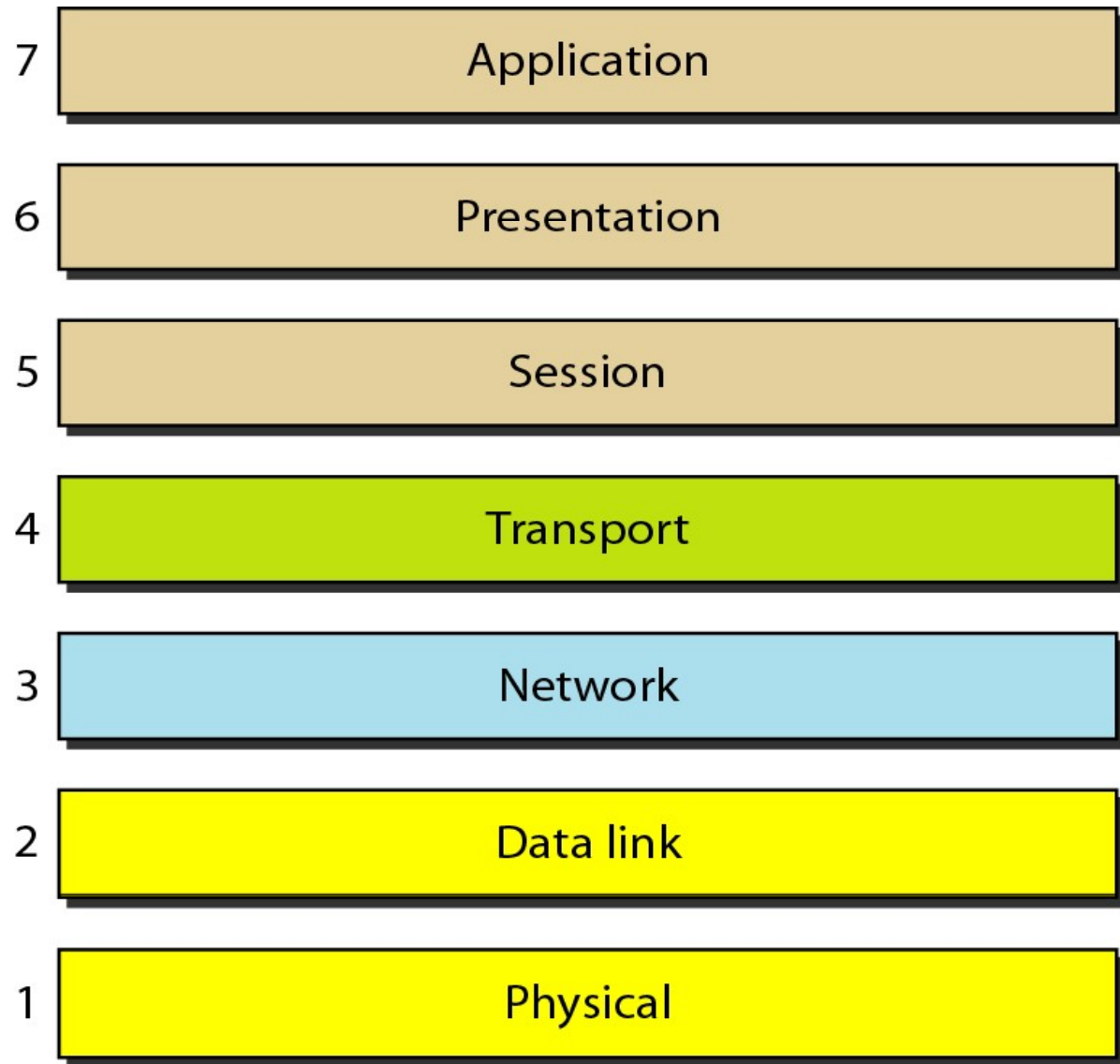

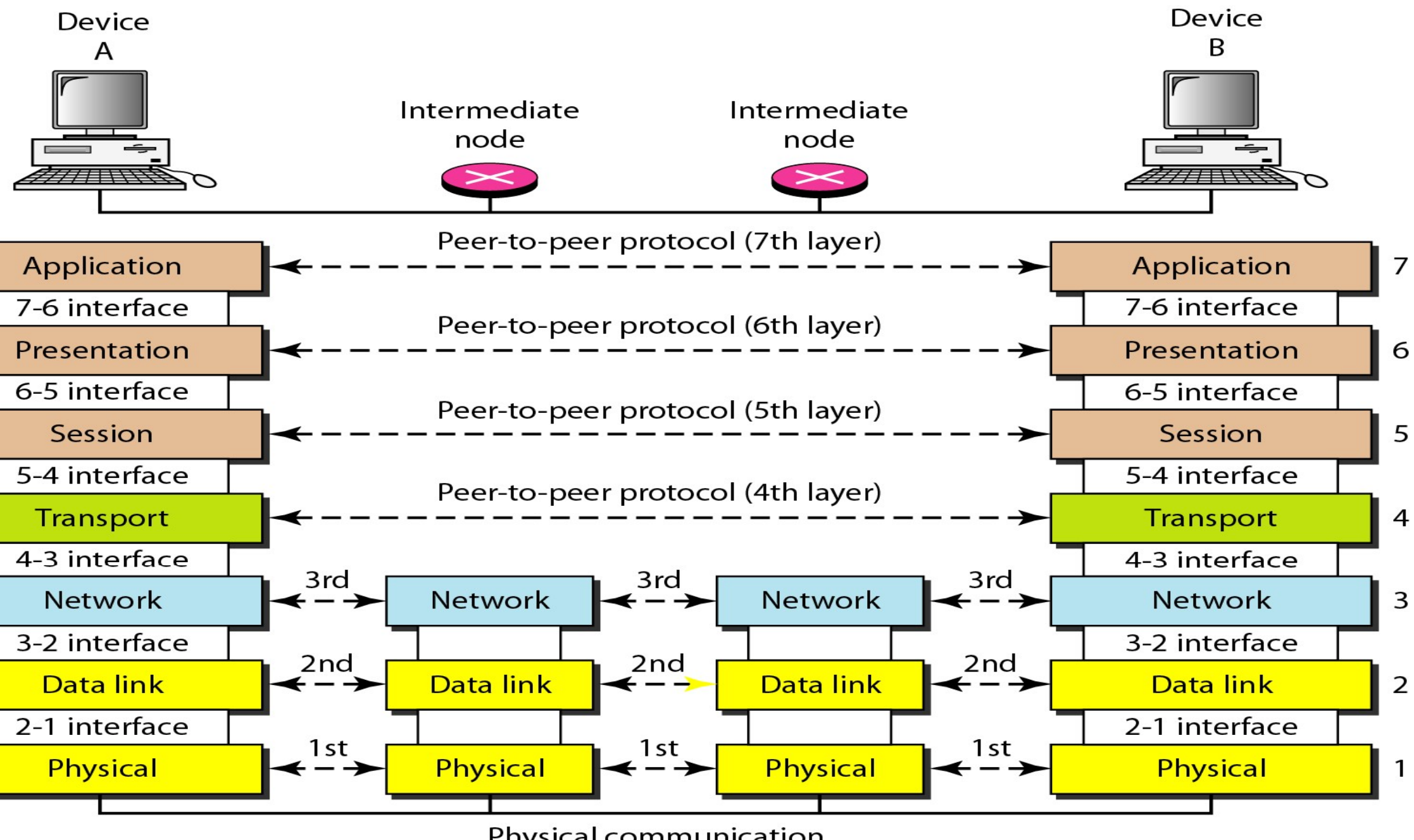

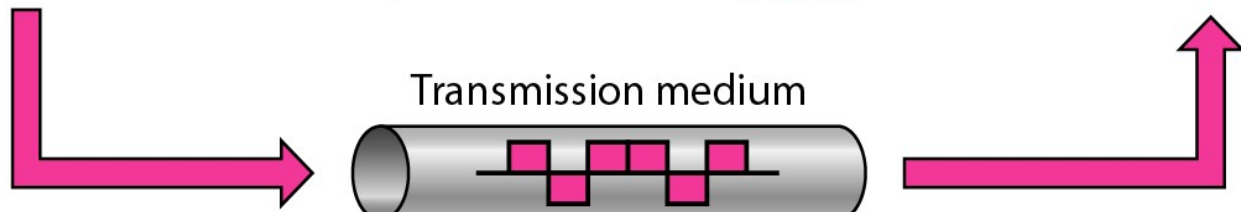
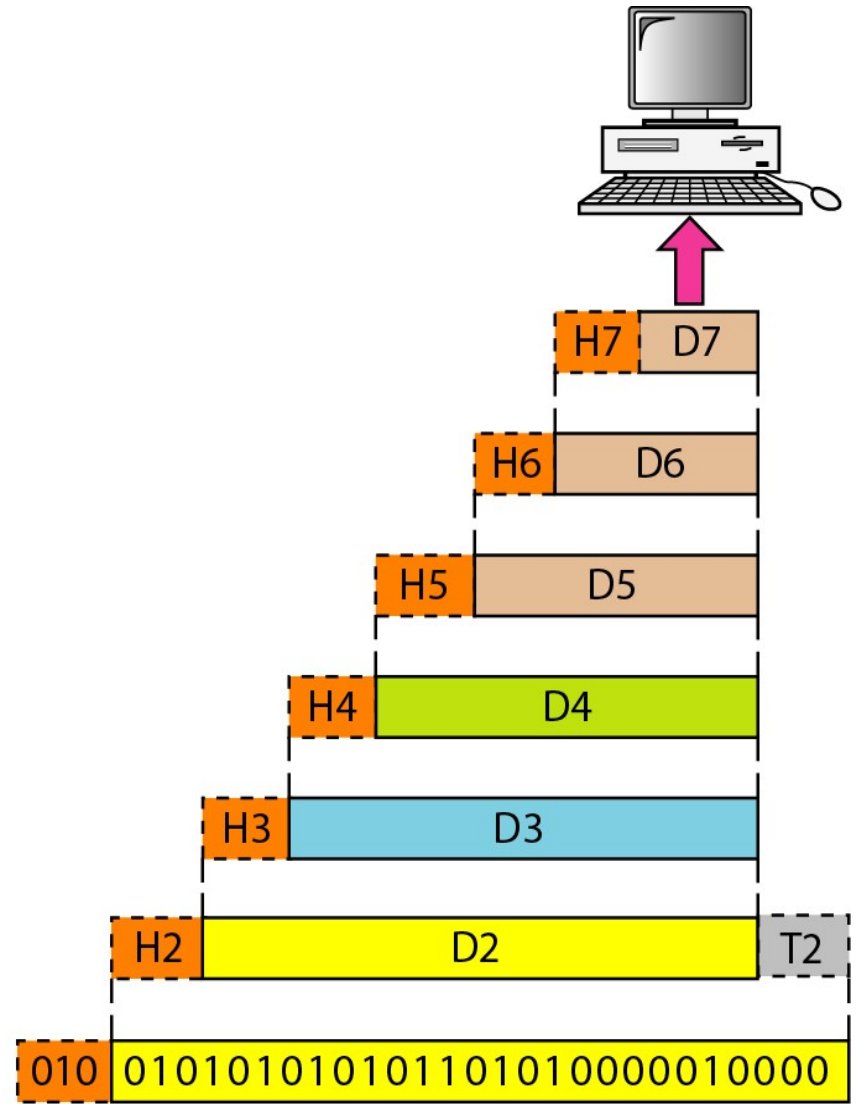
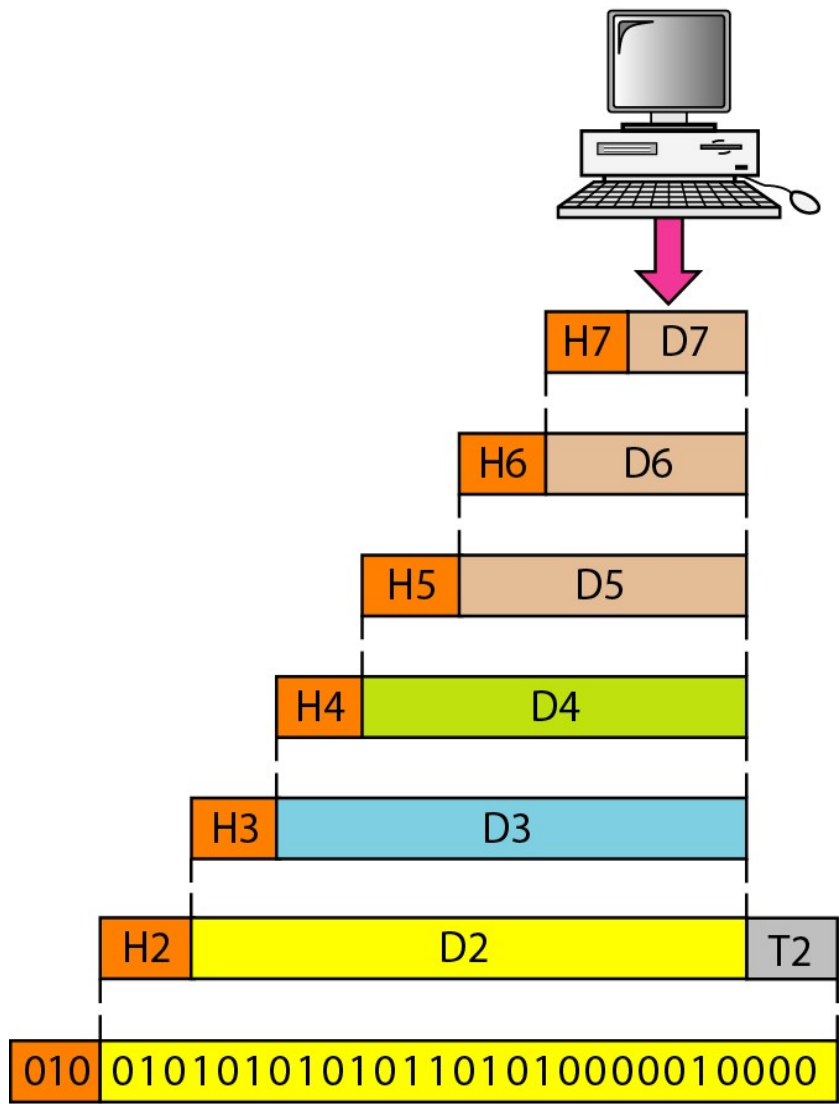

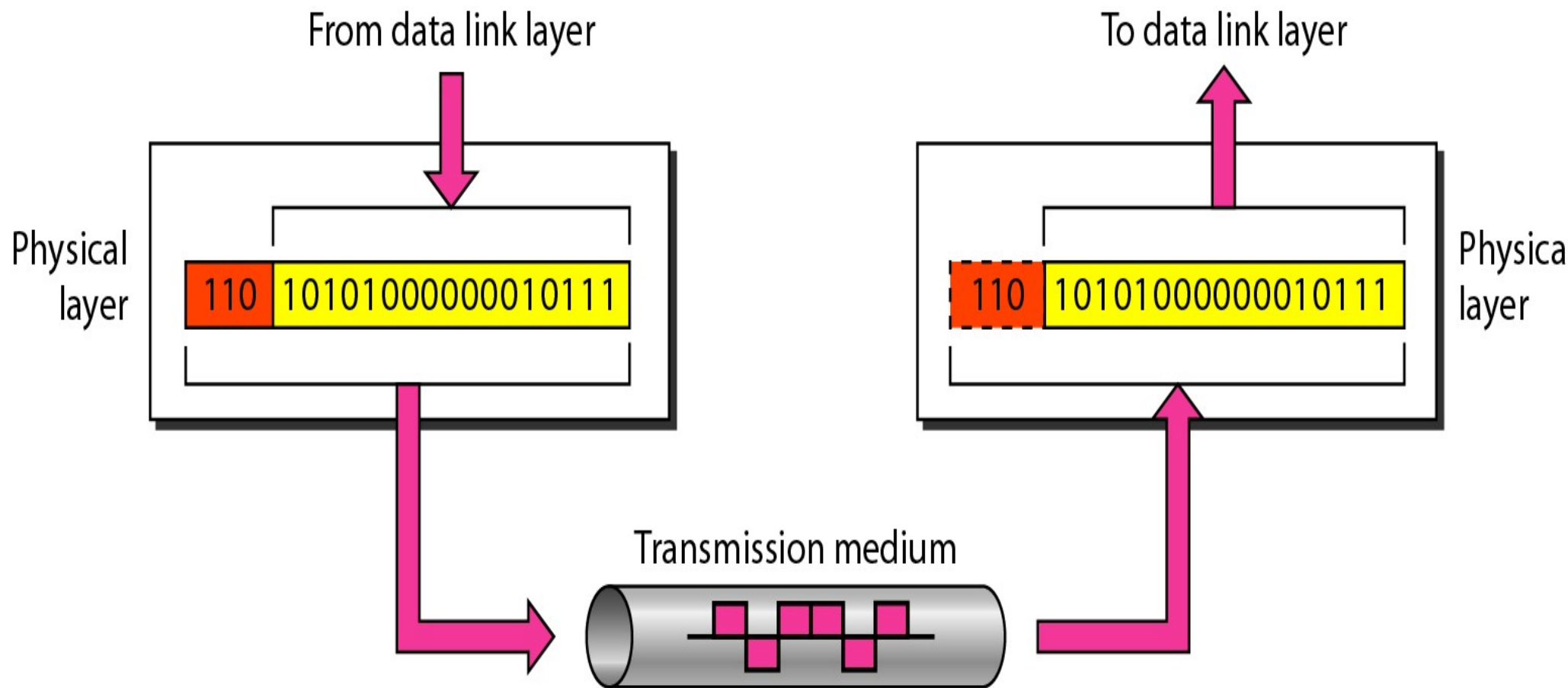

The physical layer is responsible for movements of individual bits from one hop (node) to the next.

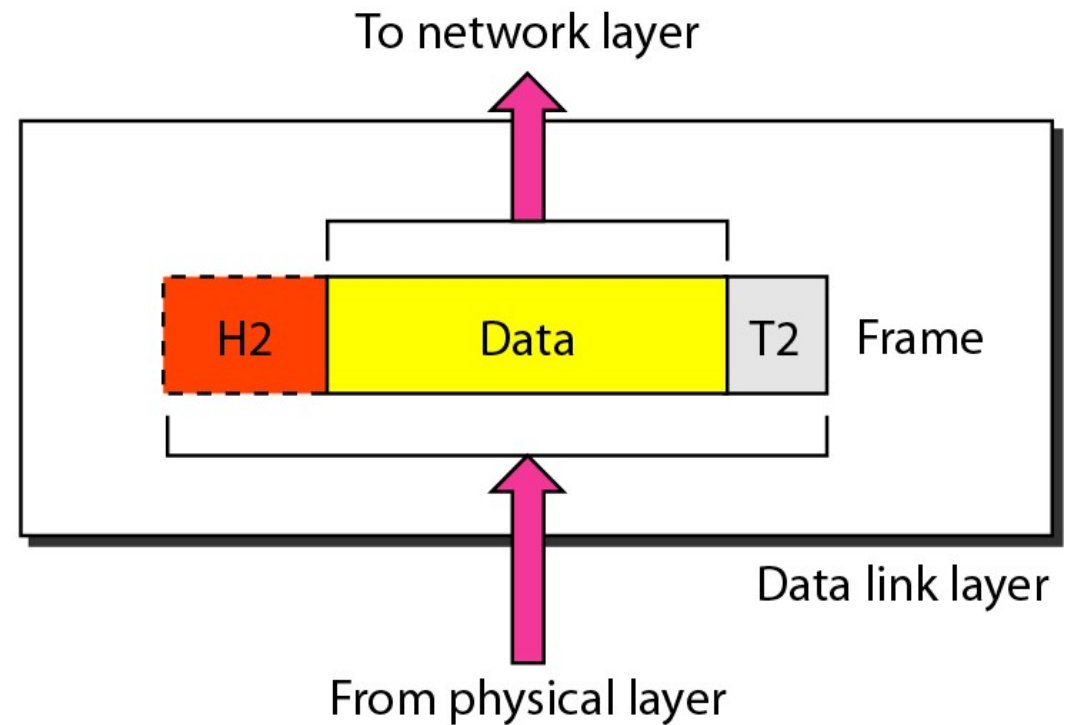
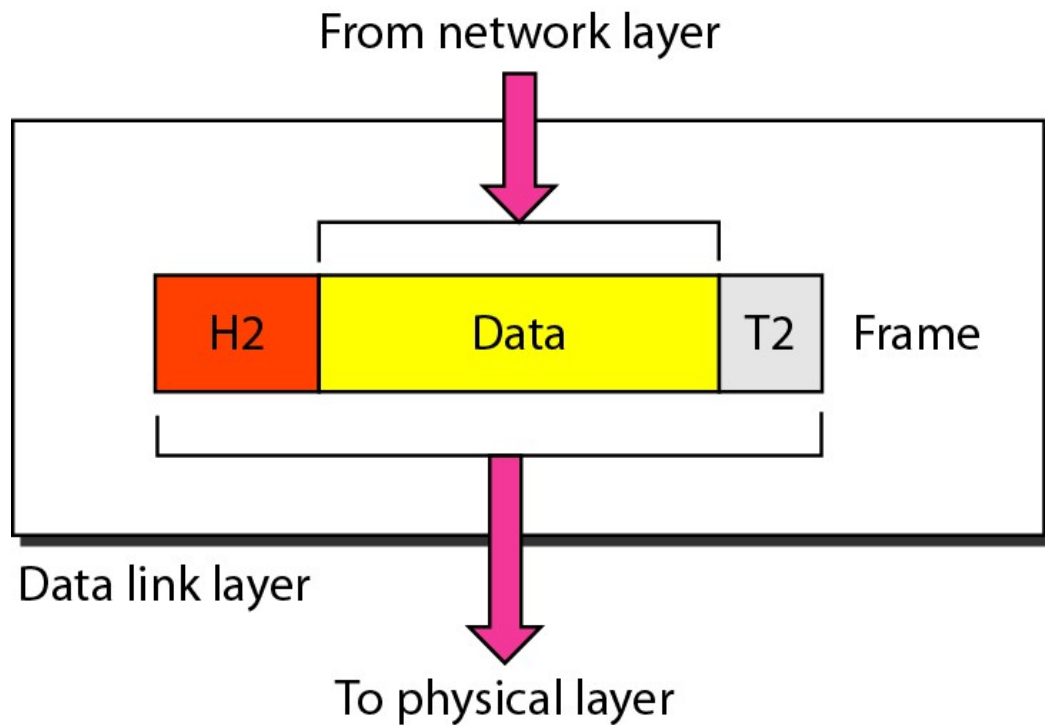

. The data link layer is responsible for moving frames from one hop (node) to the next

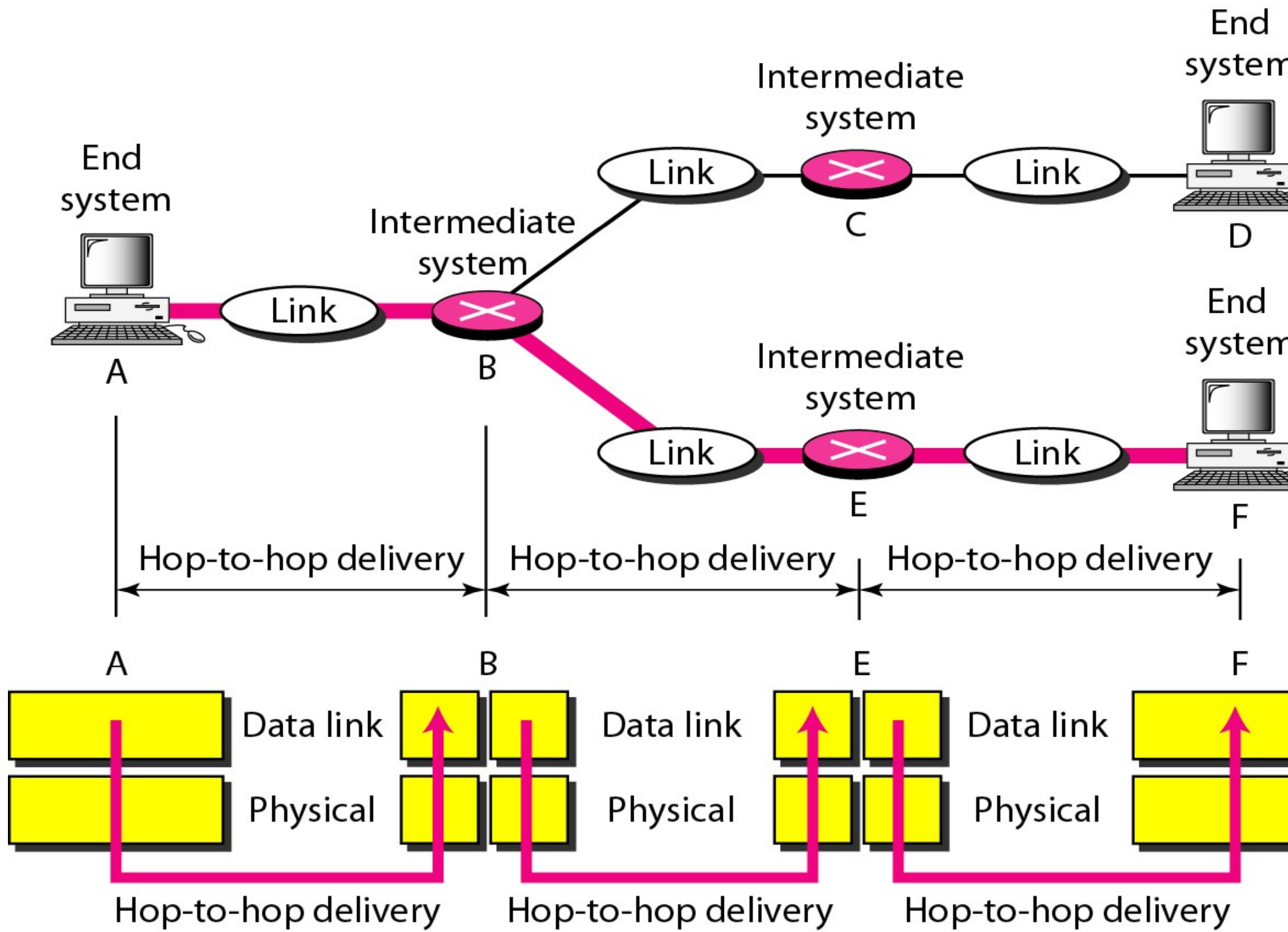

NETWORK layer

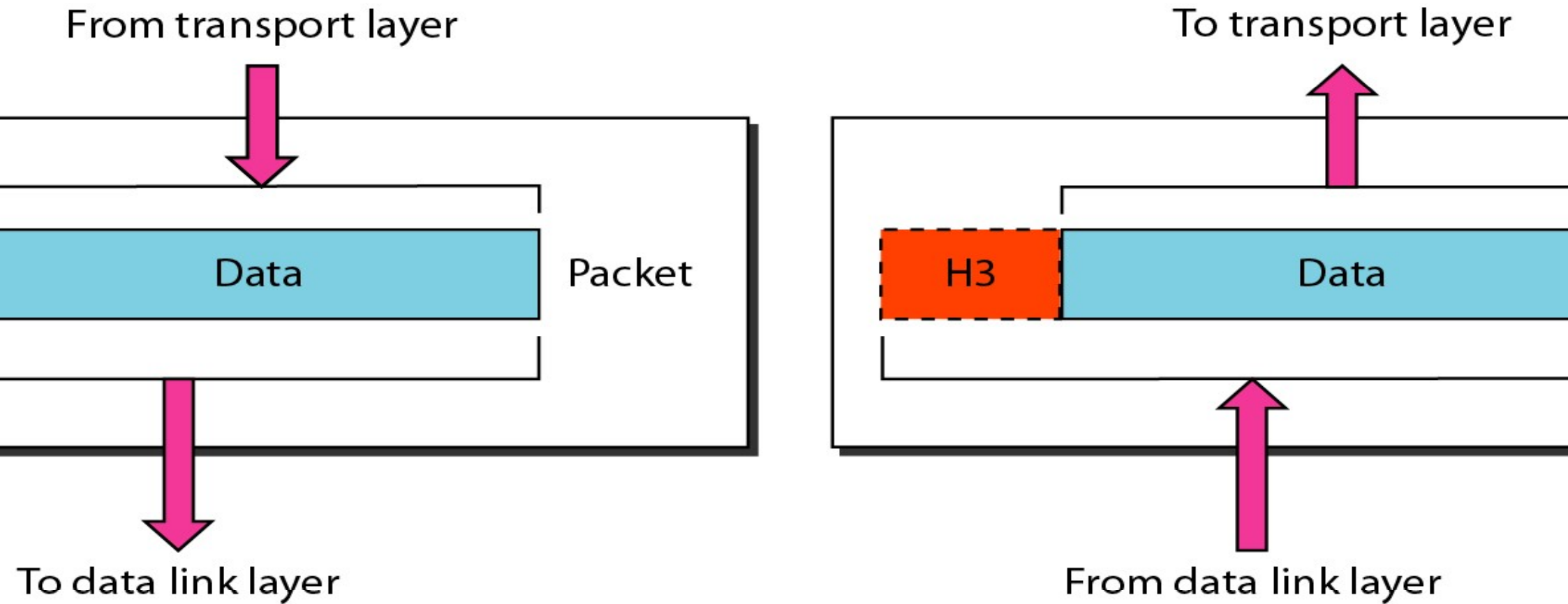

The network layer is responsible for the delivery of individual packets from the source host to the destination host.

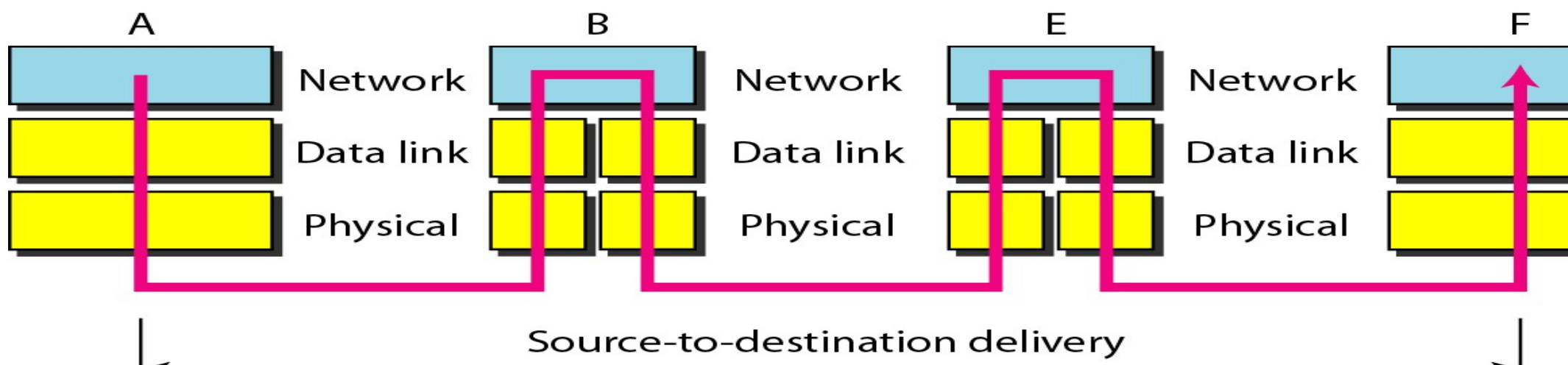
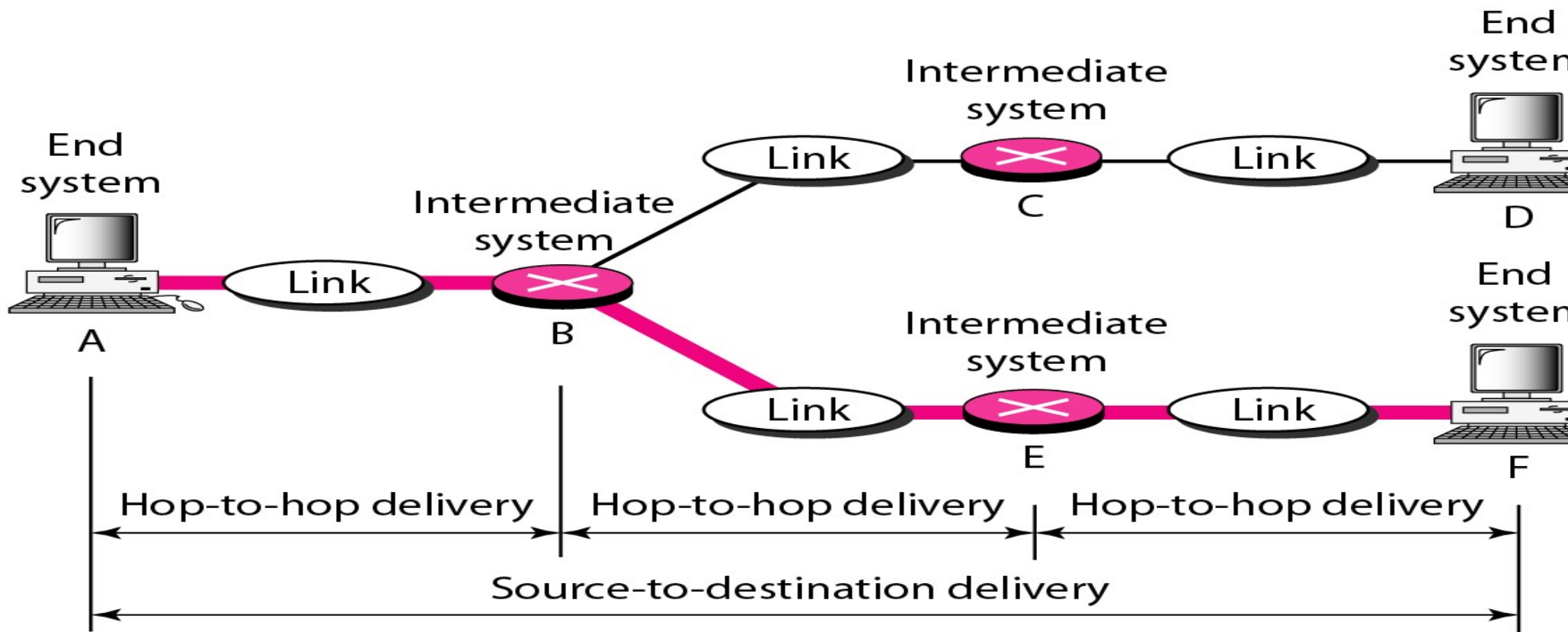

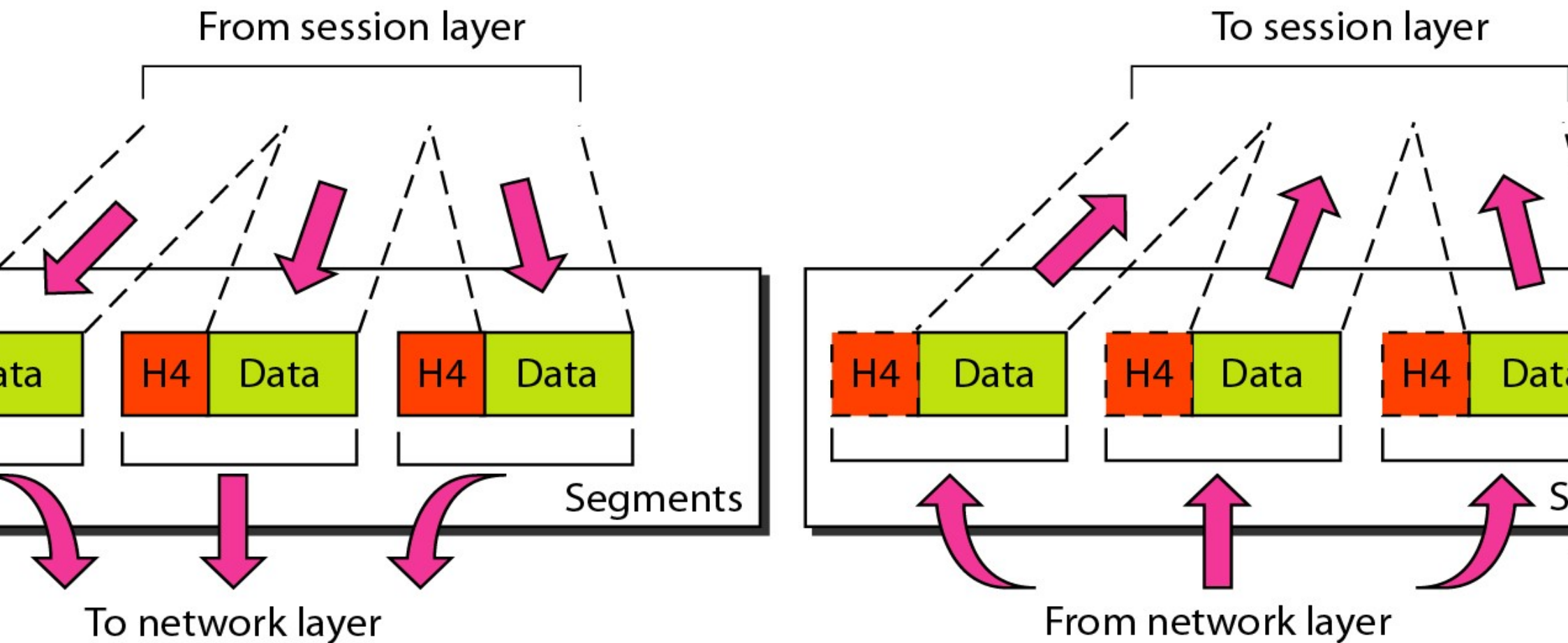

The transport layer is responsible for the delivery of a message from one process to another.

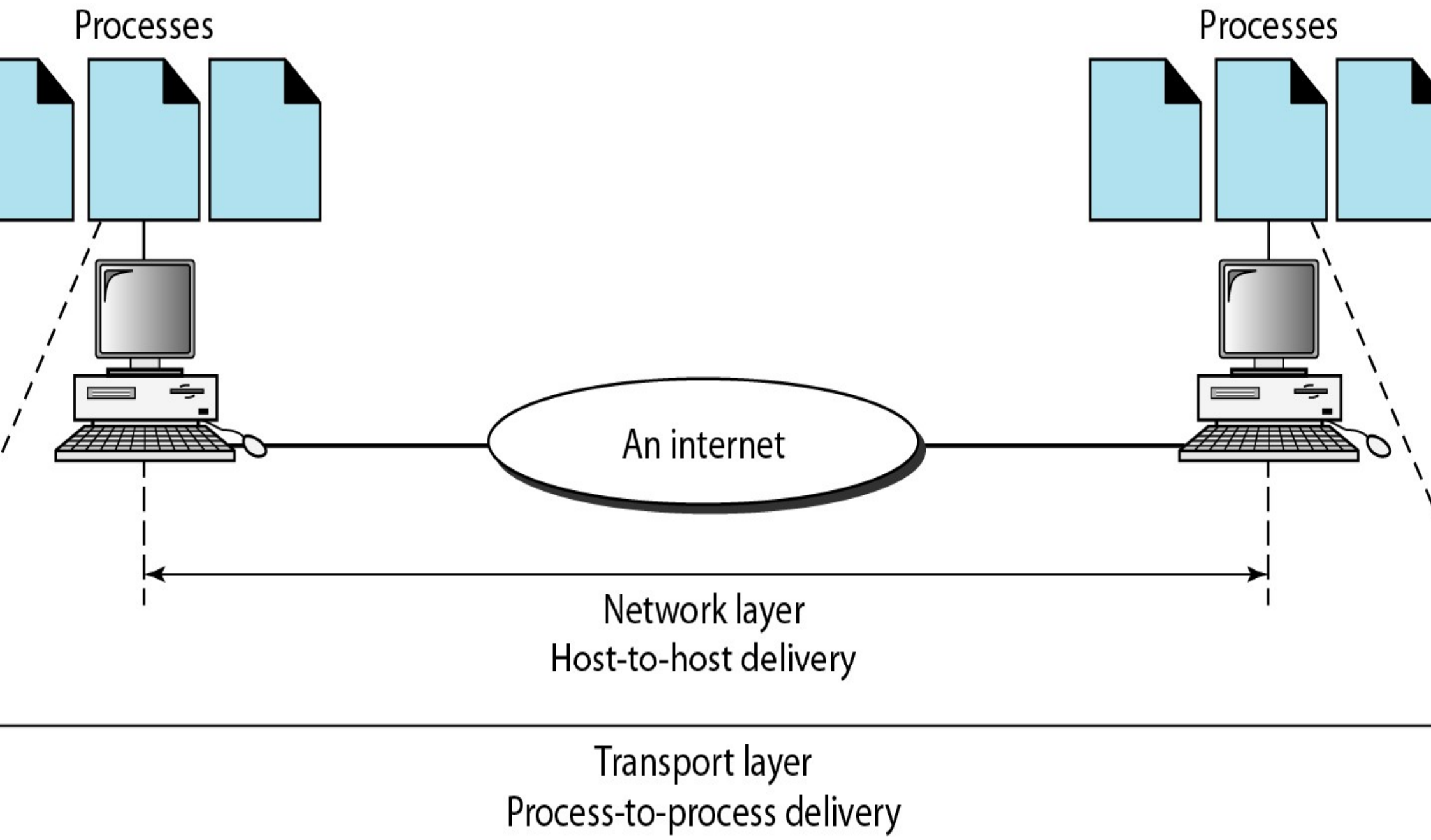

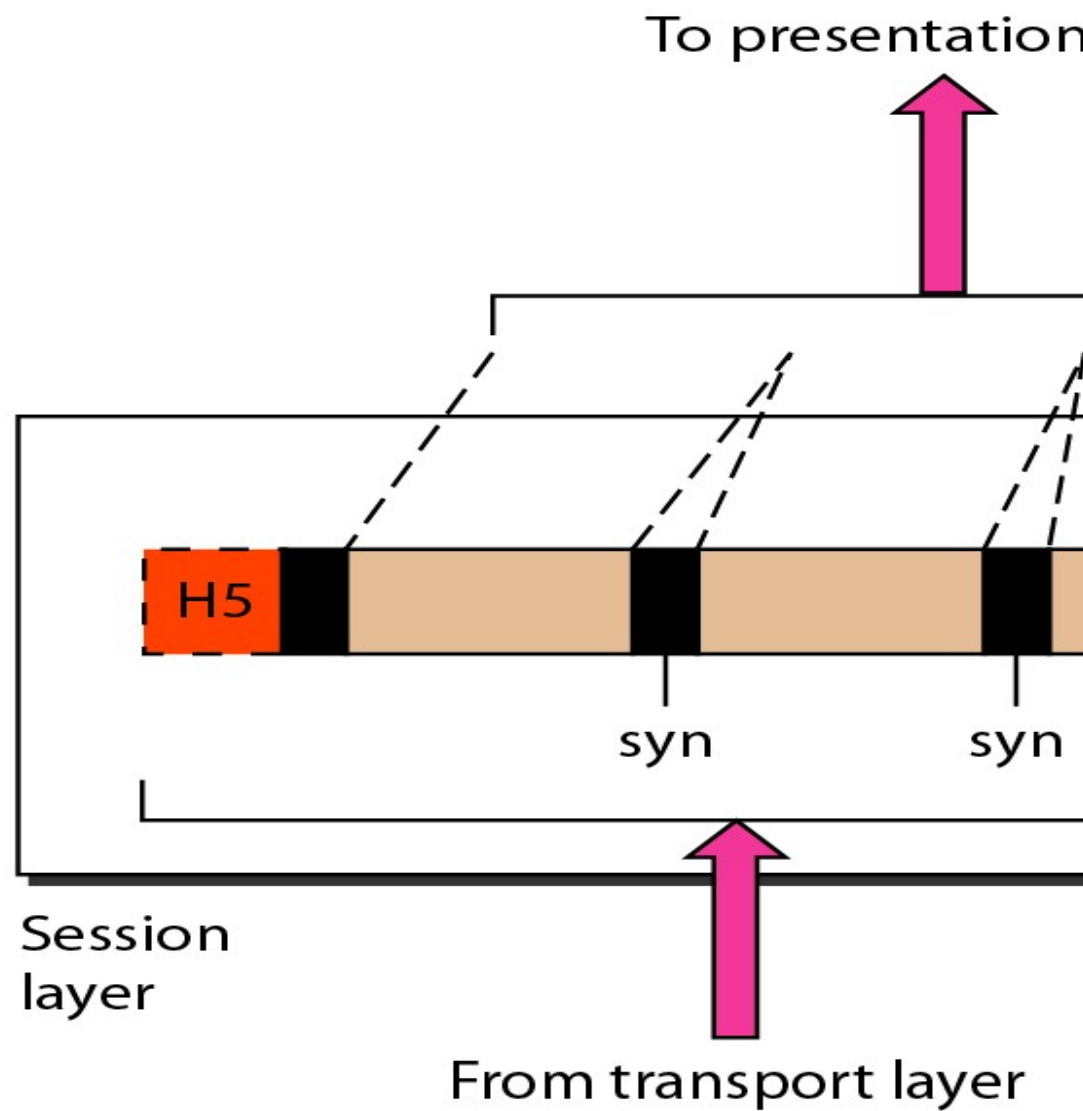
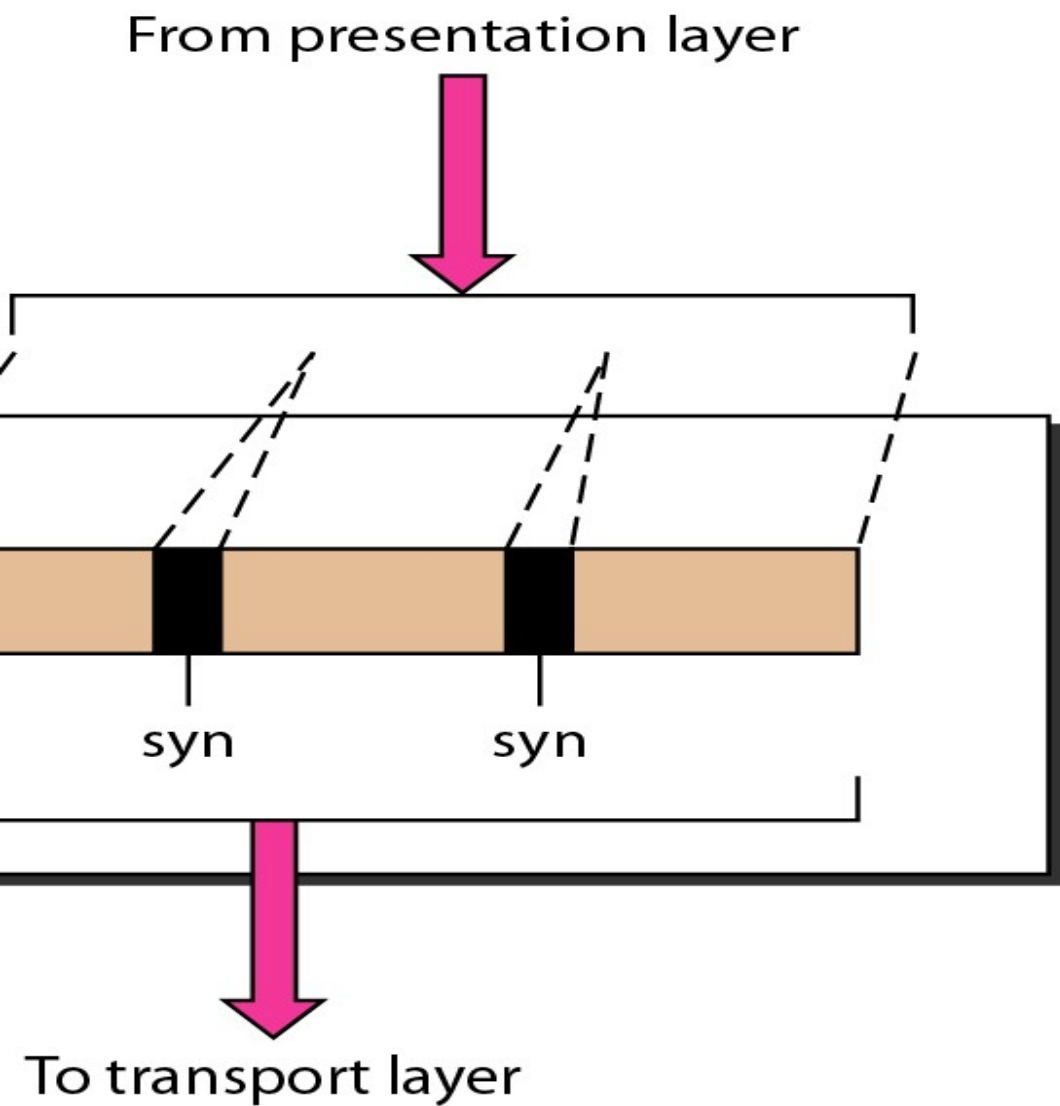

The session layer is responsible for dialog control and synchronization.

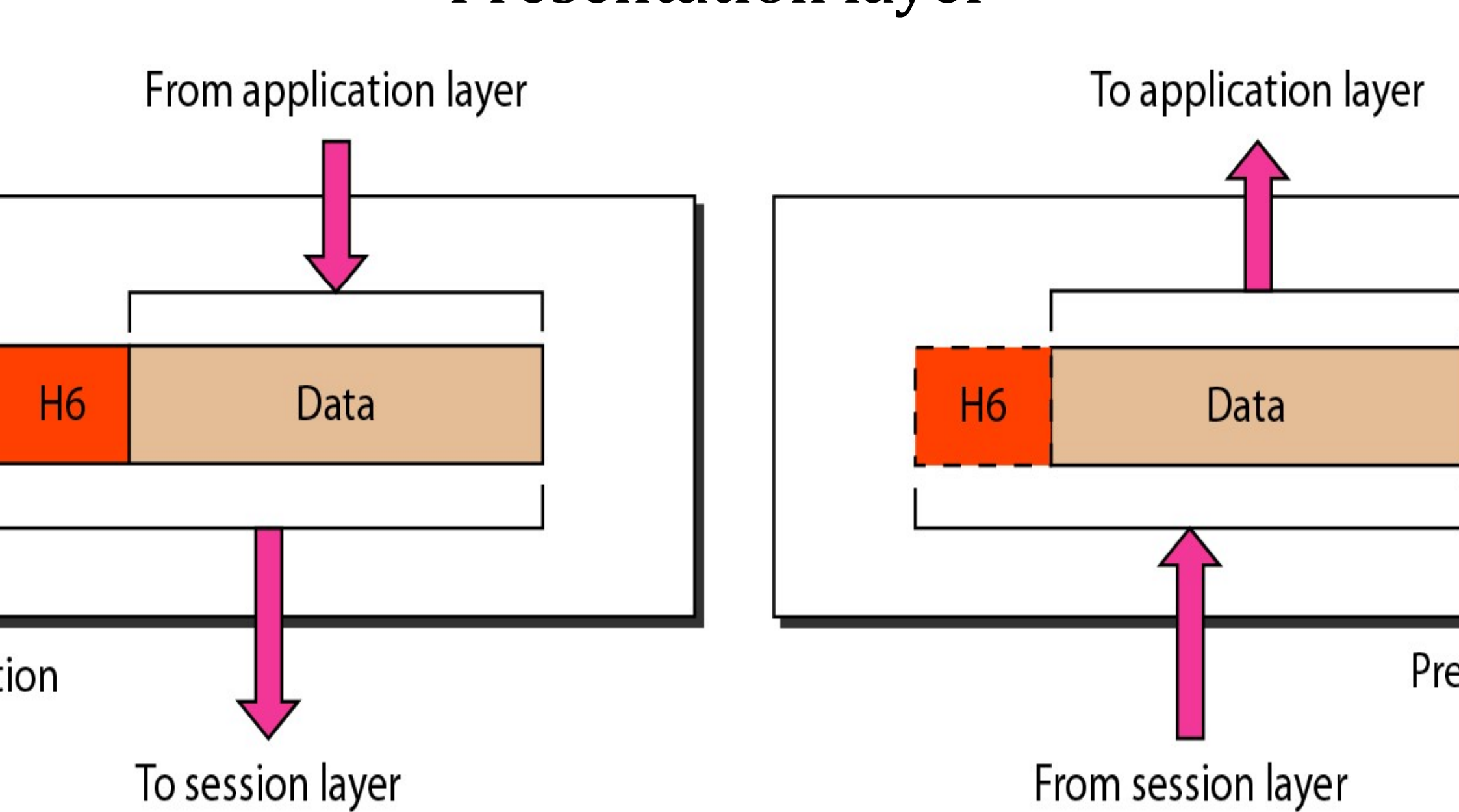

The presentation layer is responsible for translation, compression, and encryption.

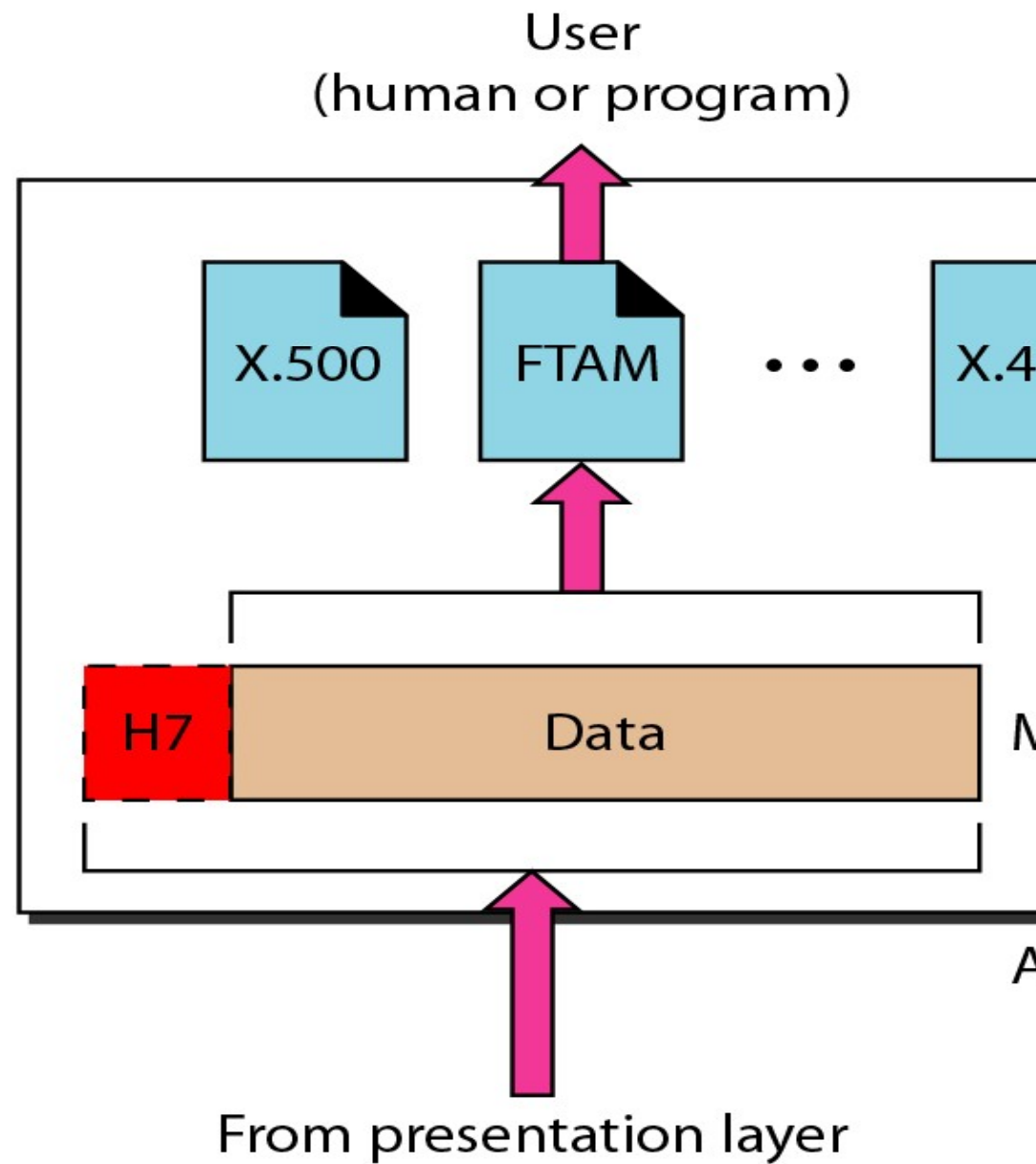
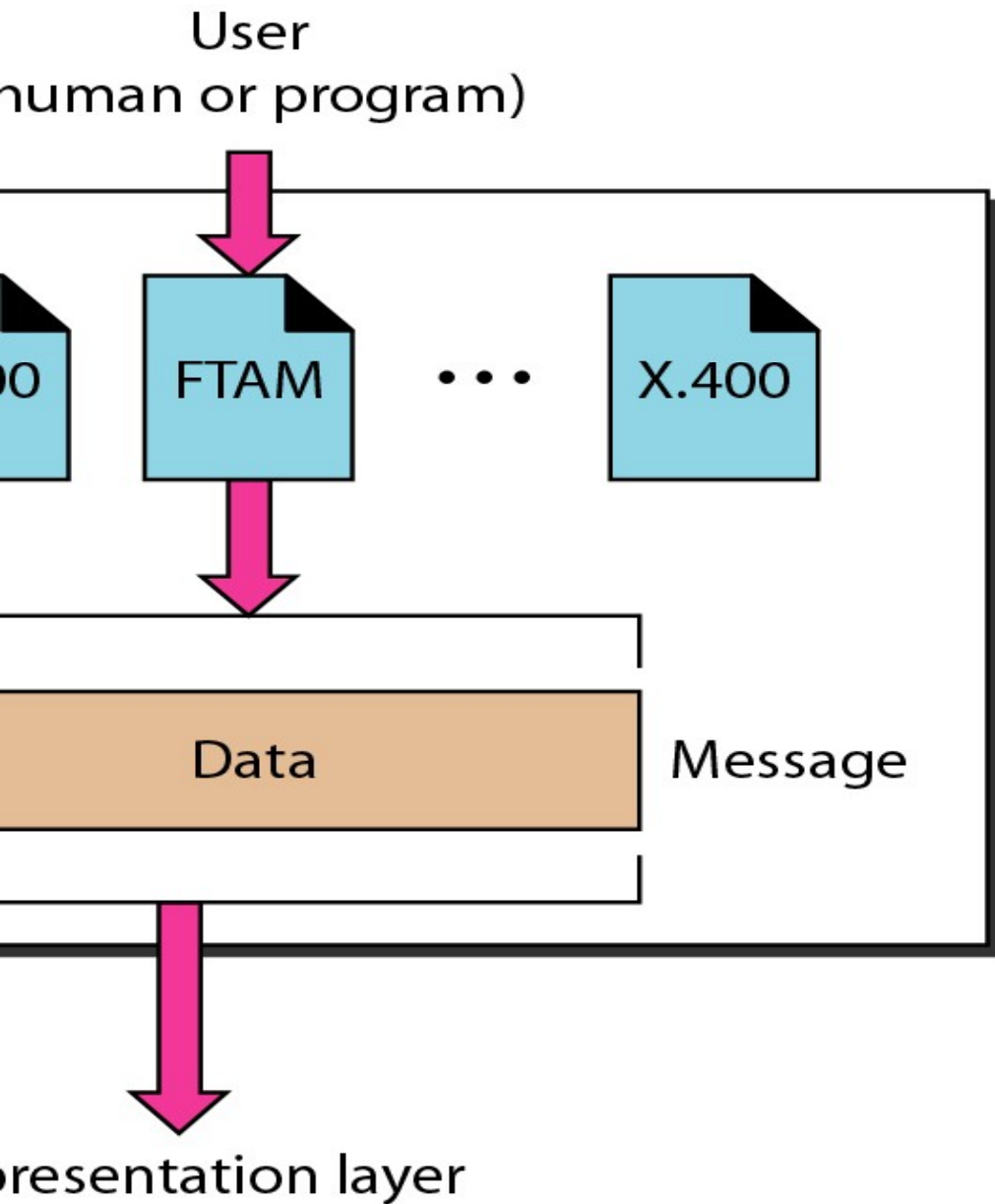

The application layer is responsible for providing services to the user.

Summary of layers

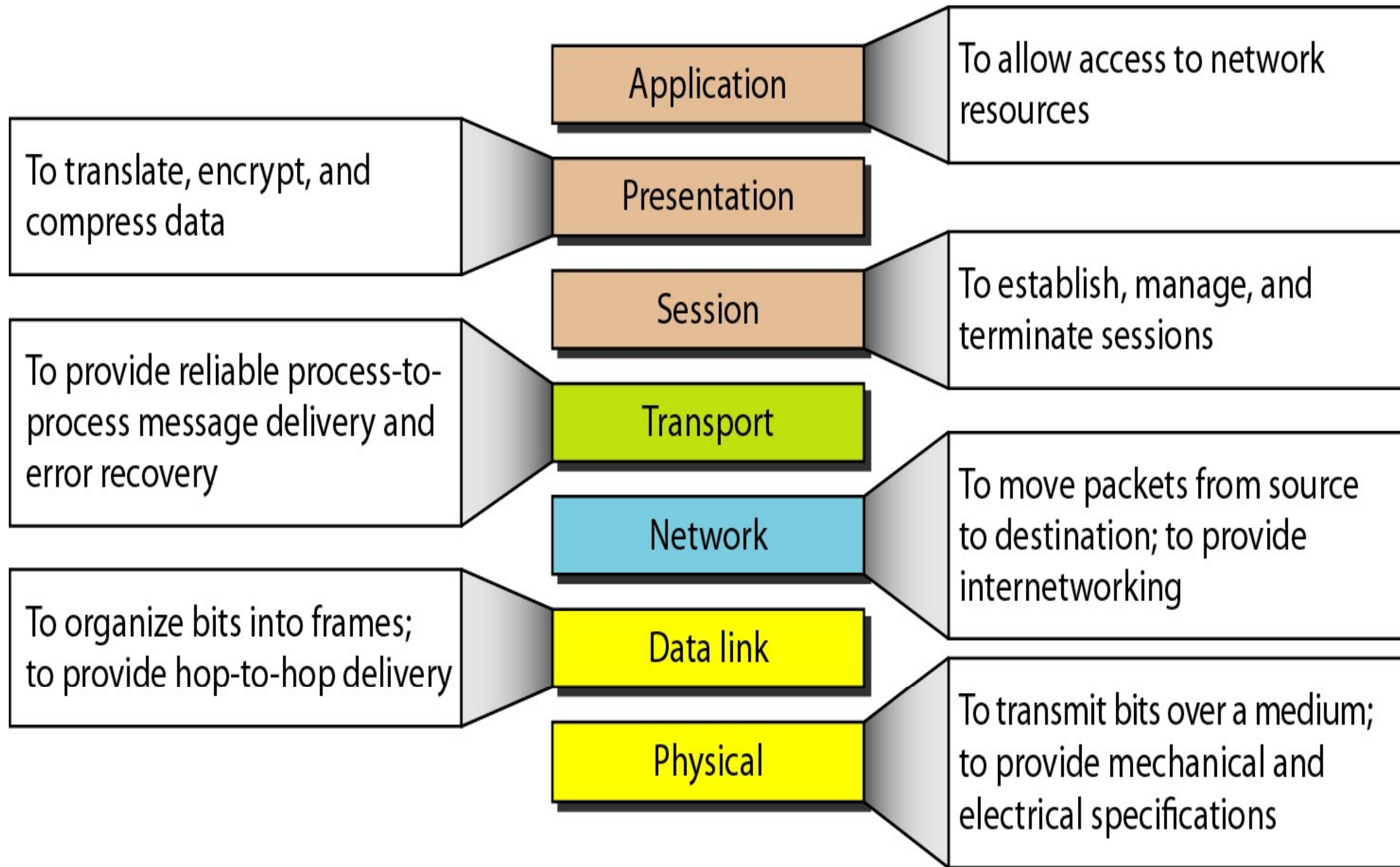

Physical layer is concerned with _____.

Data link layer takes the packets from _____ and
encapsulates them into frames for transmission.

Which of the following tasks is not done by data link layer?

Control

Control

coding

Thank You