



# **SNS COLLEGE OF TECHNOLOGY**

**Coimbatore-35**  
**An Autonomous Institution**

Accredited by NBA – AICTE and Accredited by NAAC – UGC with 'A+' Grade  
Approved by AICTE, New Delhi & Affiliated to Anna University, Chennai



## **DEPARTMENT OF INFORMATION TECHNOLOGY**

### **DATASTRUCTURES**

**II YEAR III SEM**

**UNIT 1**

**TREE ADT**



*Draw a Tree ,Mark its part and tell in which way it grows?*

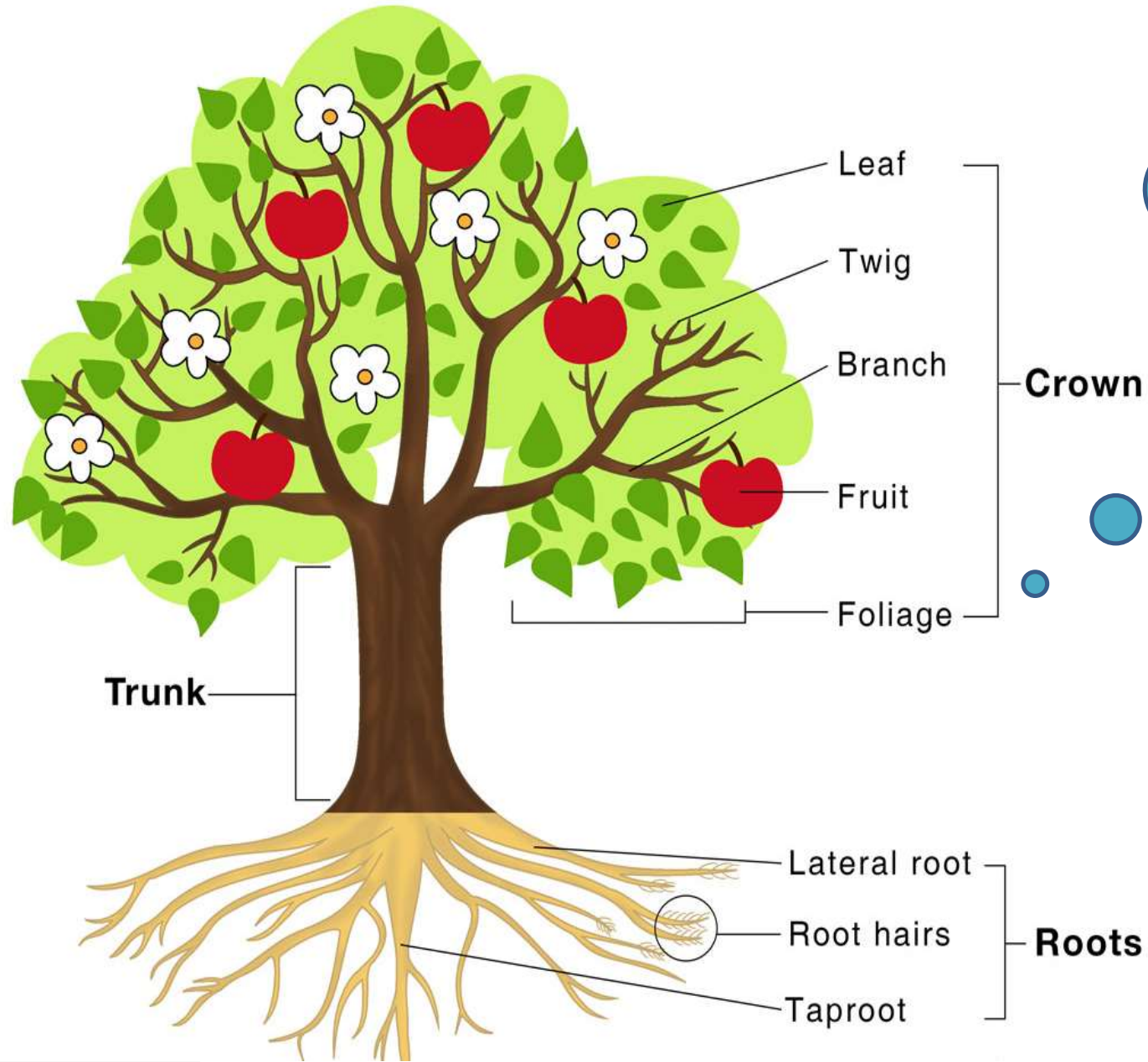

**BOTTOM TO TOP**



# TREE DATASTRUCTURE



✓ Collection of data  
(Node)

✓ Parent Child  
Relationship

✓ Hierarchical structure  
recursively

✓ 2D Datastructure

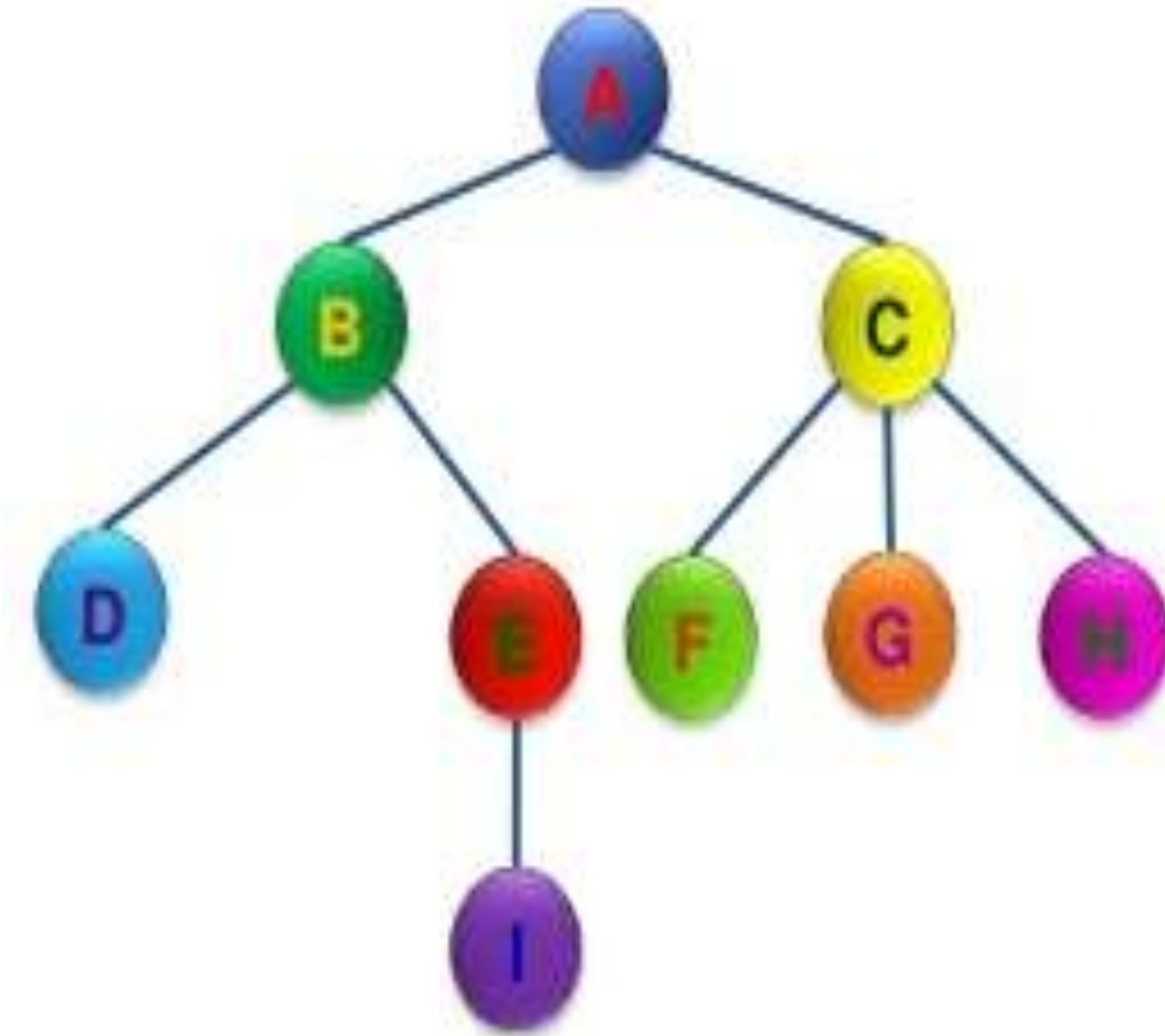
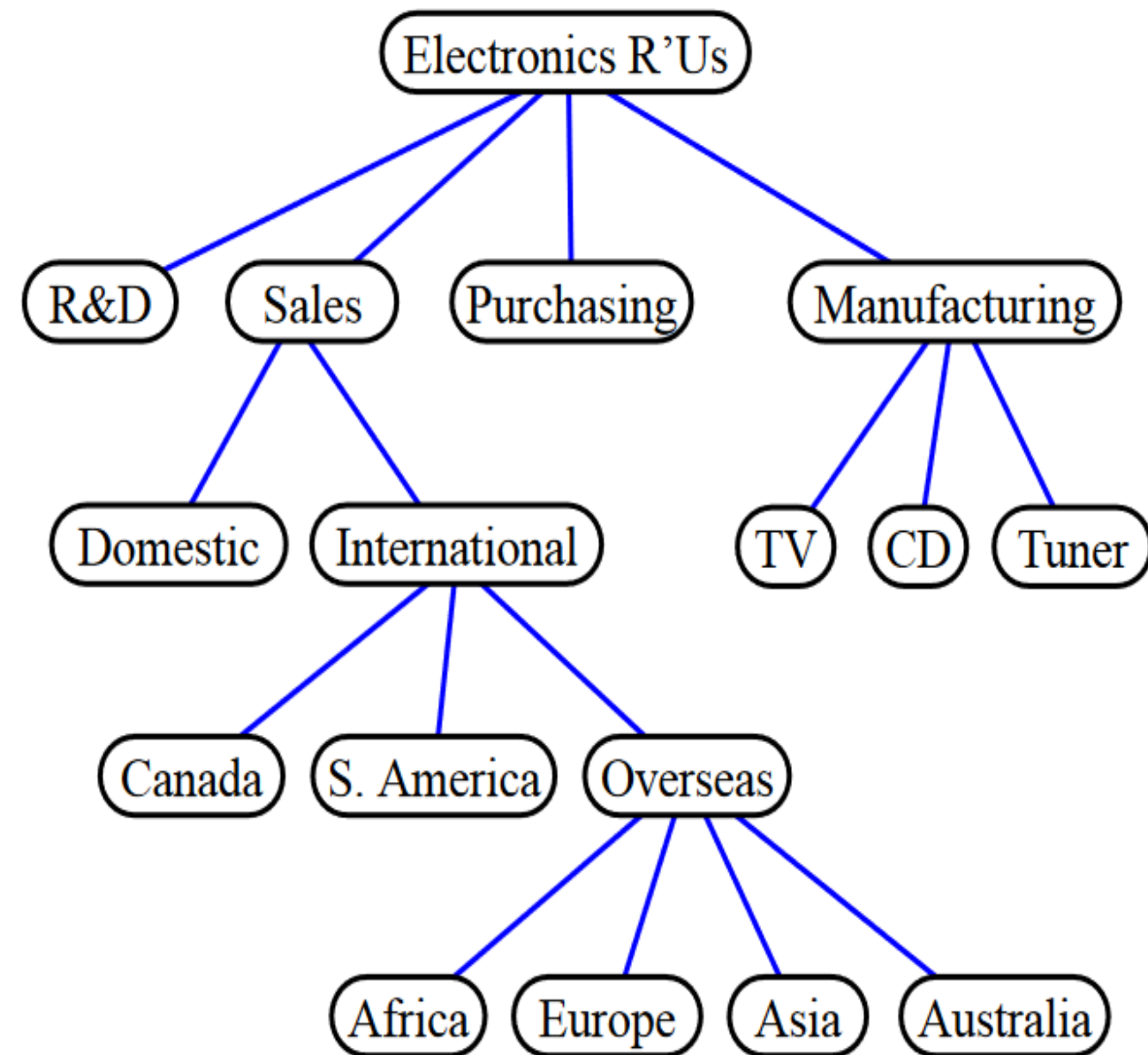

Picture Source : [quora.com](https://www.quora.com)





# TERMINOLOGIES

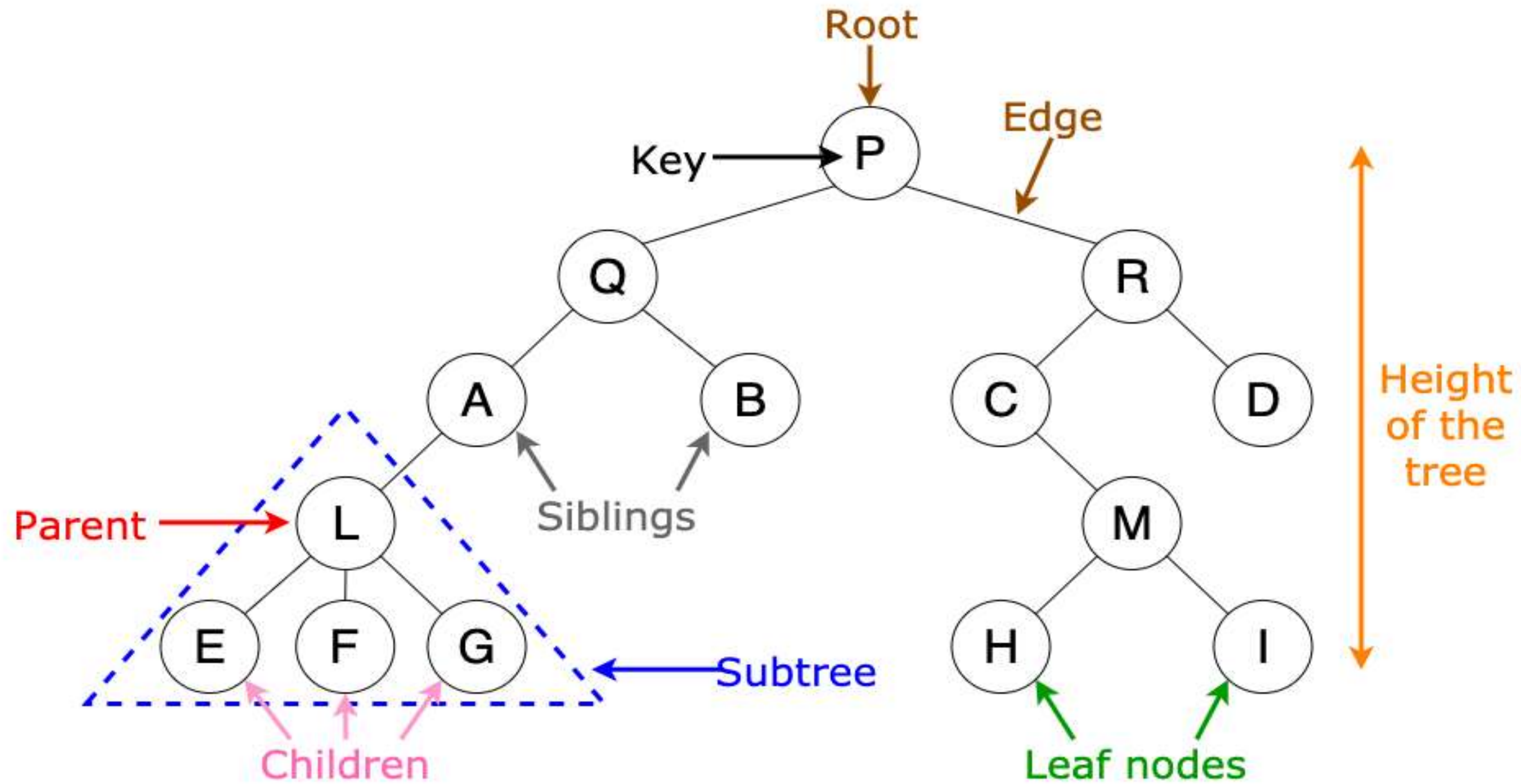

Picture Source : [geeksforgeeks.org](https://www.geeksforgeeks.org/)

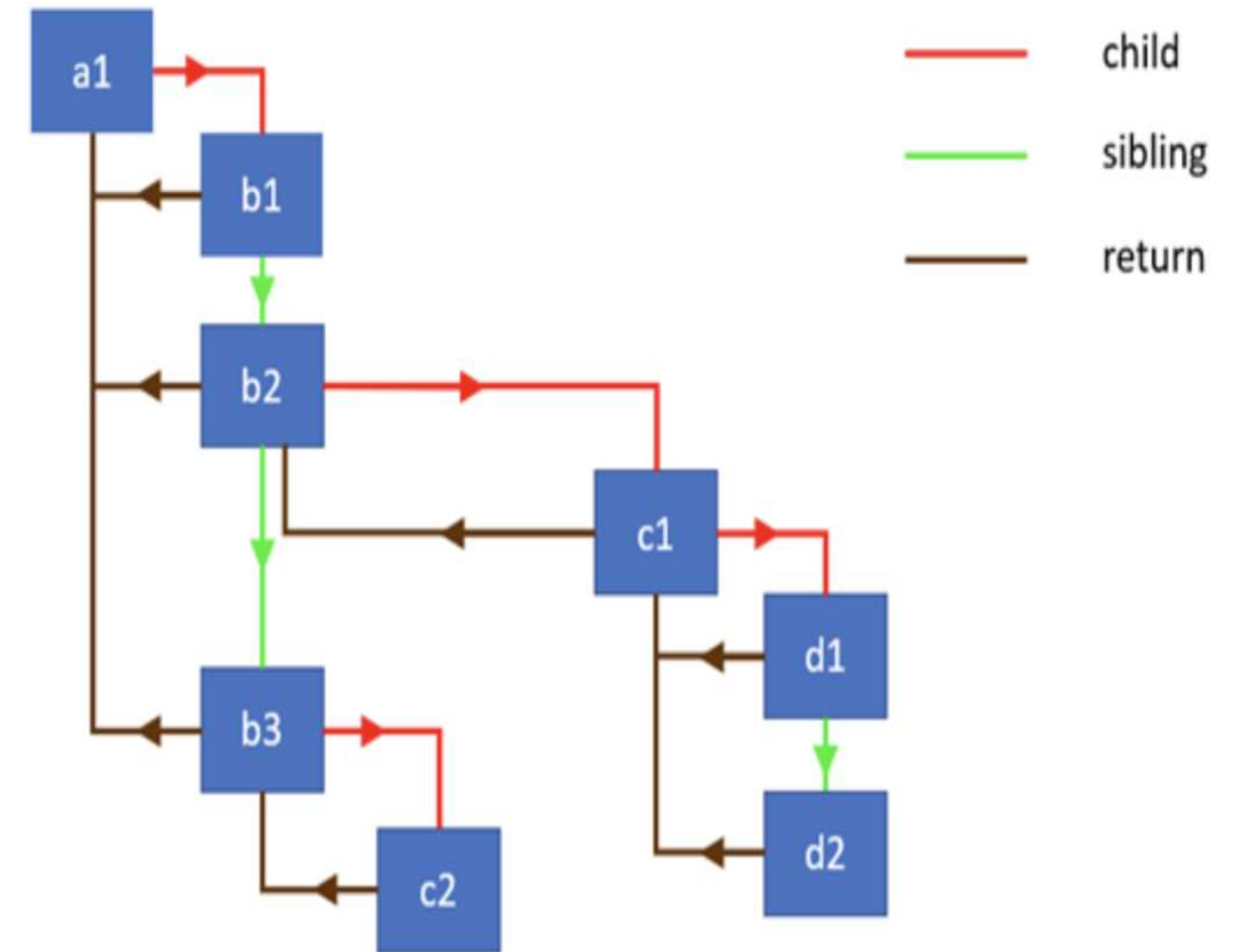
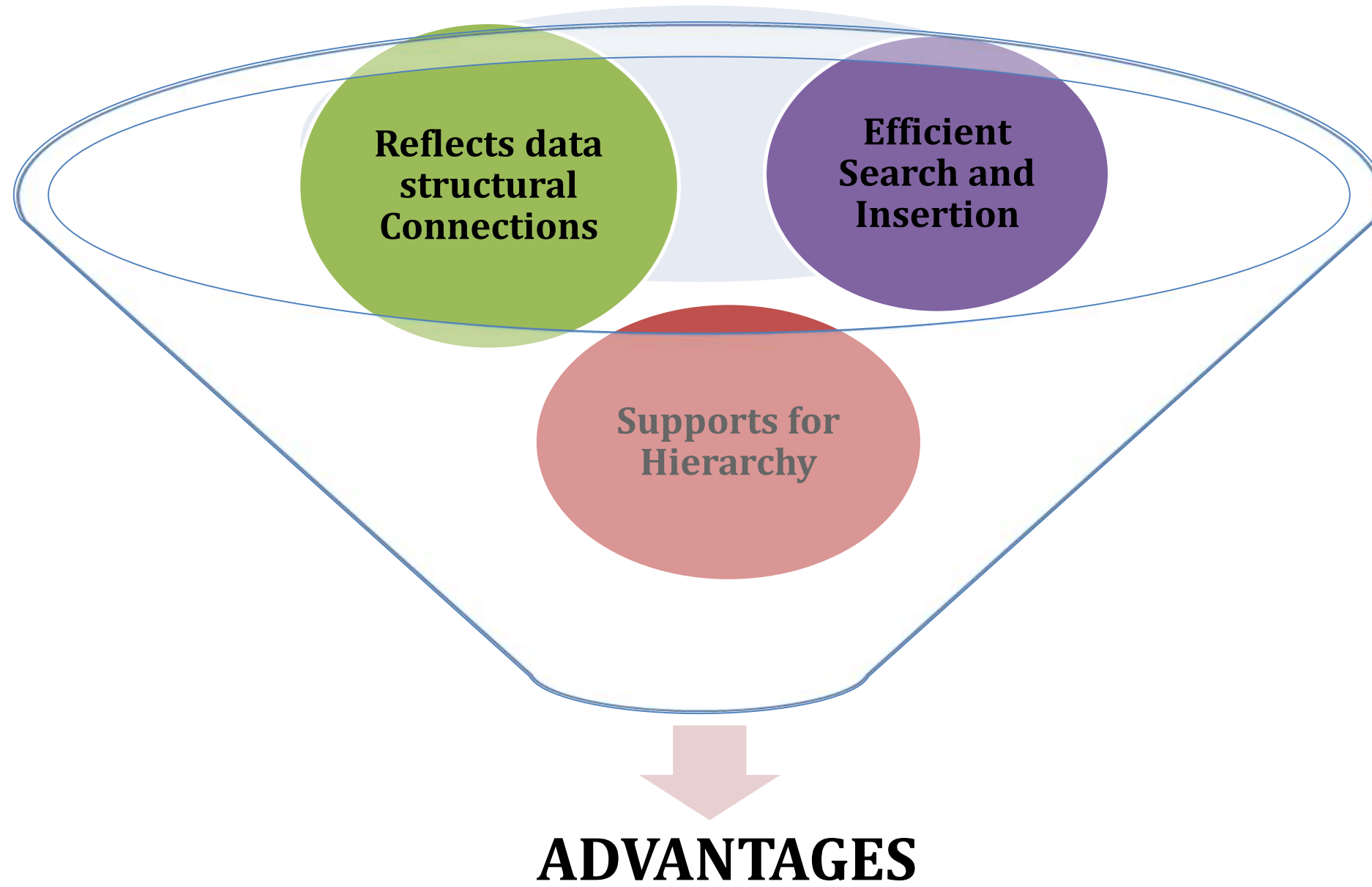



# APPLICATIONS OF TREE



File Systems

Dictionary

Network  
Routing





## ASSESSMENT - 1



1. Here is a small Tree:

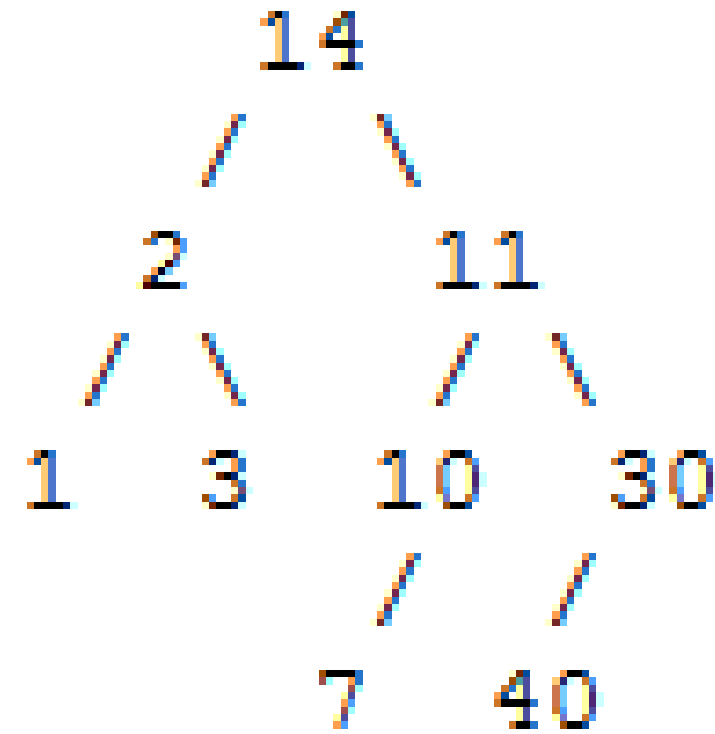

Circle all the leaves. Put a square box around the root. Draw a star around each ancestor of the node that contains 10. Put a big X through every descendant of the node that contains 10.